

**Low Profile (10 mm)
TV-5 and TV-8 Compatible
Flat Power Relay**

LK-F RELAYS



- **TV standards compatible: TV-5 and TV-8**
- TV-5 type: 78 A inrush current and switching possible at 5 A rated current.
- TV-8 type: 118 A inrush current and switching possible at 8 A rated current.
- **Line up includes silent type**
Approx. 10 dB less sound pressure than LK-S relay.

- **High sensitivity: 250mW**
Ideal for device power reduction
- **0.7 mm .028 inch stand off height**

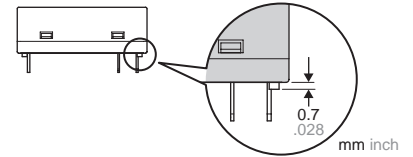

- **Conforms to various safety standards**
UL, C-UL, TÜV and SEMKO

TYPICAL APPLICATIONS

- Flat-panel TVs
- Audio visual equipment
- Other slim profile devices

FEATURES

- **Low profile (10 mm height)**
Height reduced 60% compared with previous product*.

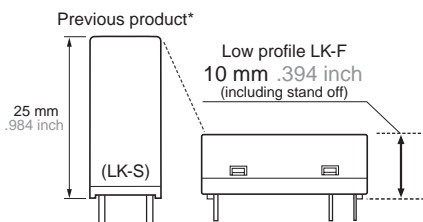

*Previous product: LK-S relay

- **Nominal switching capacity: 5A, 8A 277V AC**

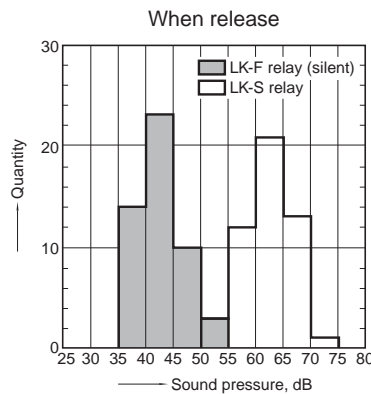
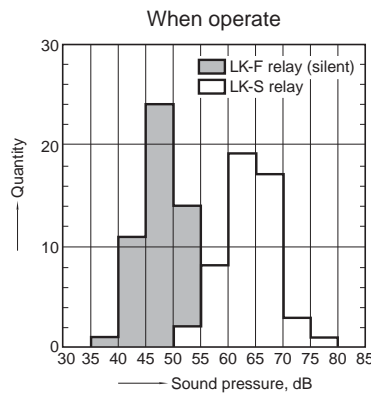

ORDERING INFORMATION

LKF 1a M - 1 2 V - 1 - 5

Contact arrangement
1a: 1 Form A

Nominal operating power
M: 250mW

Operation noise
Nil: Standard type
Q: Silent type

Coil voltage (DC)
5, 9, 12, 24V

TV standard
5: TV-5
8: TV-8

Note: UL/C-UL, T+V, SEMKO approved type is standard.

TYPES

Contact arrangement	Nominal coil voltage	Part No.			
		TV-5 type		TV-8 type	
		Standard type	Silent type	Standard type	Silent type
1 Form A	5V DC	LKF1aM-5V-1-5	LKF1aMQ-5V-1-5	LKF1aM-5V-1-8	LKF1aMQ-5V-1-8
	9V DC	LKF1aM-9V-1-5	LKF1aMQ-9V-1-5	LKF1aM-9V-1-8	LKF1aMQ-9V-1-8
	12V DC	LKF1aM-12V-1-5	LKF1aMQ-12V-1-5	LKF1aM-12V-1-8	LKF1aMQ-12V-1-8
	24V DC	LKF1aM-24V-1-5	LKF1aMQ-24V-1-5	LKF1aM-24V-1-8	LKF1aMQ-24V-1-8

Standard packing: Tube: 50 pcs.; Case: 500 pcs.

*Operation noise standard type is available, please contact us.

RATING

1. Coil data

Nominal coil voltage	Pick-up voltage (at 20°C 68°F) (JIS C 5442* pulse drive.)		Drop-out voltage (at 20°C 68°F)	Nominal operating current [±10%] (at 20°C 68°F)	Coil resistance [±10%] (at 20°C 68°F)	Nominal operating power	Max. applied voltage (at 20°C 68°F)
	Standard type	Silent type					
5V DC	70%V or less of nominal voltage (Initial)	80%V or less of nominal voltage (Initial)	10%V or more of nominal voltage (Initial)	50 mA	100Ω	250mW	130%V of nominal voltage
9V DC				27.8mA	324Ω		
12V DC				20.8mA	576Ω		
24V DC				10.4mA	2,304Ω		

*JIS C 5442: JIS C 5442-1986 test method for miniature electromagnetic relays used for control applications.

2. Specifications

Characteristics	Item	Specifications		
		TV-5 type	TV-8 type	
Contact	Arrangement	1 Form A		
	Contact resistance (Initial)	Max. 100 mΩ (By voltage drop 6 V DC 1A)		
	Contact material	AgSnO ₂ type		
Rating	Nominal switching capacity (resistive load)	5 A 277 V AC	8 A 277 V AC	
	Contact carrying power	1,385 VA	2,216 VA	
	Max. switching voltage	277 V AC		
	Max. switching current	5 A (AC)	8 A (AC)	
	Min. switching capacity (Reference value)*1	100 mA 5 V DC		
Electrical characteristics	Insulation resistance (Initial)	Min. 1,000MΩ (at 500V DC) Measurement at same location as "Breakdown voltage" section.		
	Breakdown voltage (Initial)	Between open contacts	1,000 Vrms for 1 min. (Detection current: 10 mA)	
		Between contact and coil	4,000 Vrms for 1 min. (Detection current: 10 mA)	
	Surge breakdown voltage*2	Between contact and coil	10,000 V (initial)	
	Temperature rise (at 20°C 68°F)		Max. 45°C 113°F (By resistive method, nominal voltage applied to the coil; contact carrying current: 5 A at 70°C 158°F.)	Max. 45°C 113°F (By resistive method, nominal voltage applied to the coil; contact carrying current: 8 A at 70°C 158°F.)
	Operate time (at 20°C 68°F)		Max. 15 ms (nominal coil voltage, excluding contact bounce time)	
Release time (at 20°C 68°F)		Max. 5 ms (nominal coil voltage, excluding contact bounce time) (without diode)		
Mechanical characteristics	Shock resistance	Functional	Min. 200 m/s ² (Half-wave pulse of sine wave: 11 ms; detection time: 10 μs.)	
		Destructive	Min. 1,000 m/s ² (Half-wave pulse of sine wave: 6 ms.)	
	Vibration resistance	Functional	10 to 55 Hz at double amplitude of 1.5 mm (Detection time: 10 μs.)	
		Destructive	10 to 55 Hz at double amplitude of 1.5 mm	
Expected life	Mechanical	Min. 10 ⁶ (at 180 cpm)		
	Electrical	Min. 10 ⁵ (at 20 cpm)	Min. 5×10 ⁴ (at 20 cpm)	
Conditions	Conditions for operation, transport and storage*3	Ambient temperature: -40°C to +70°C -40°F to +158°F; Humidity: 5 to 85% R.H. (Not freezing and condensing at low temperature); Atmospheric pressure: 86 to 106 kPa		
	Max. operating speed	20 cpm (at nominal switching capacity)		
Unit weight		Approx. 12 g .42 oz		

Notes:

*1. This value can change due to the switching frequency, environmental conditions, and desired reliability level, therefore it is recommended to check this with the actual load.

*2. Wave is standard shock voltage of ±1.2×50μs according to JEC-212-1981

*3. The upper operation ambient temperature limit is the maximum temperature that can satisfy the coil temperature rise value.

Refer to 1. Usage, transport and storage conditions in NOTES.

Refer to "6. Usage, Storage and Transport Conditions" in [AMBIENT ENVIRONMENT section in Relay Technical Information](#).

REFERENCE DATA

1. Max. switching power (AC resistive load)

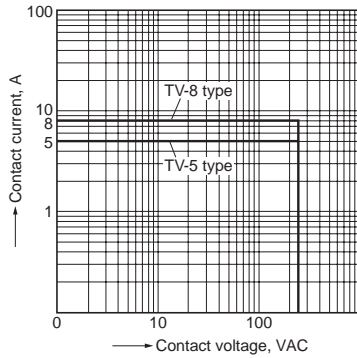

2-(1). Coil temperature rise (TV-5 type)

Sample: LKF1aMQ-12V-1-5, 6 pcs.
Point measured: coil inside
Contact current: 0A, 5A

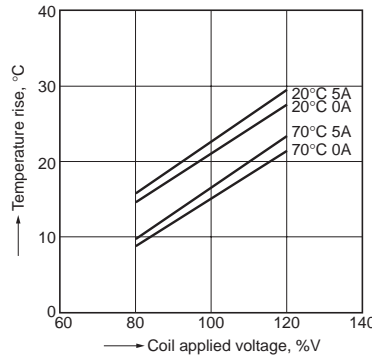

2-(2). Coil temperature rise (TV-8 type)

Sample: LKF1aMQ-12V-1-8, 6 pcs.
Point measured: coil inside
Contact current: 0A, 8A

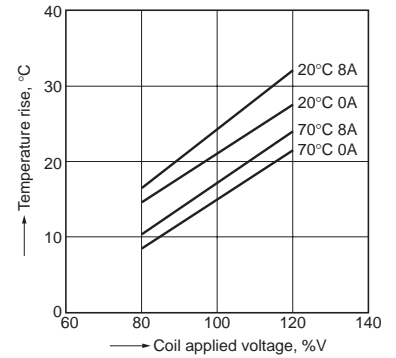

3-(1). Ambient temperature characteristics and coil applied voltage (TV-5 type)

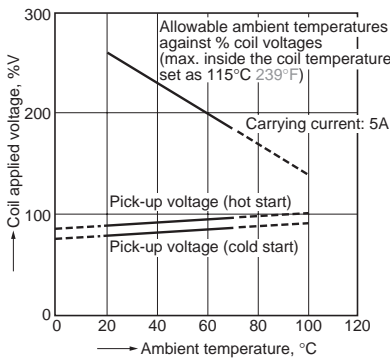

3-(2). Ambient temperature characteristics and coil applied voltage (TV-8 type)

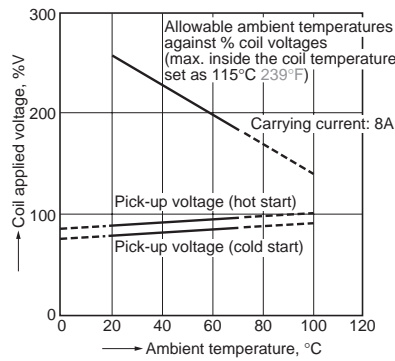

4-(1). Electrical life test (5A 277V AC, resistive load)

Sample: LKF1aMQ-12V-1-5, 6 pcs.
Operation frequency: 20 times/min.
(ON/OFF = 1.5s: 1.5s)
Ambient temperature: 20°C 68°F

Circuit:

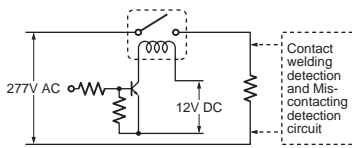

Change of pick-up and drop-out voltage

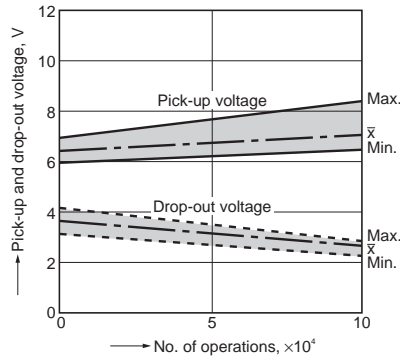

Change of contact resistance

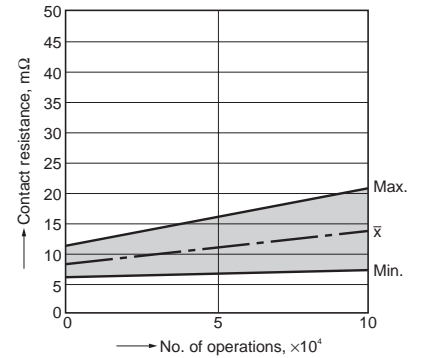

4-(2). Electrical life test (8A 277V AC, resistive load)

Sample: LKF1aMQ-12V-1-8, 6 pcs.
Operation frequency: 20 times/min.
(ON/OFF = 1.5s: 1.5s)
Ambient temperature: 20°C 68°F

Circuit:

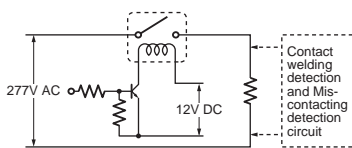

Change of pick-up and drop-out voltage

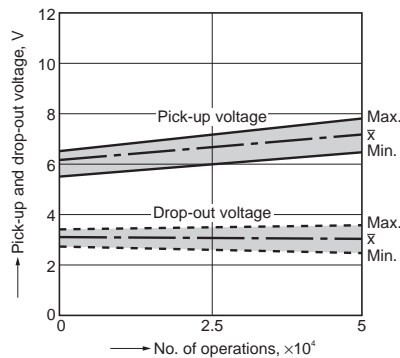

Change of contact resistance

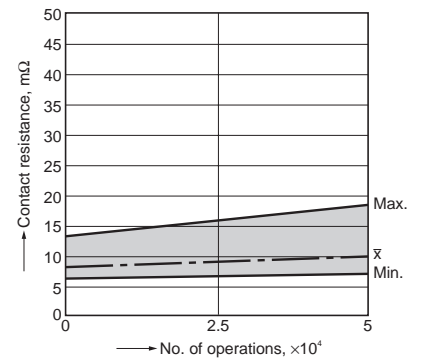

LK-F

5-(1). Operation noise distribution

LK-F (Height: 10 mm, Silent)

Measuring conditions
 Sample: LKF1aMQ-12V-1-5, 50pcs
 Background noise: approx. 20dB
 Coil voltage: 12V DC
 Equipment setting: "A" weighted
 Single part (refer to figure below)
 With diode

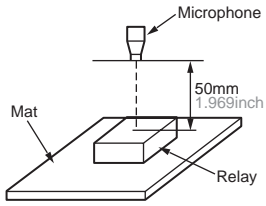

When operate

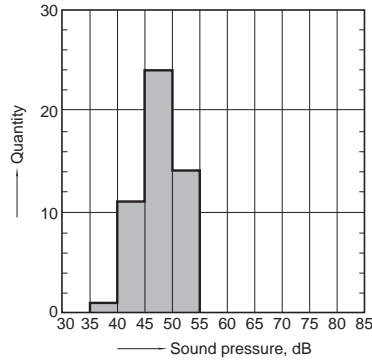

When release

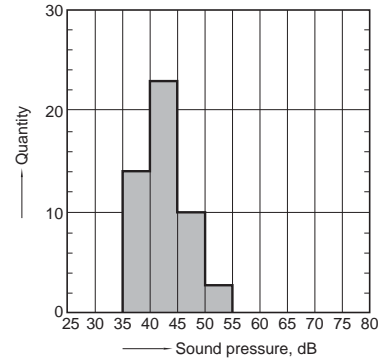

5-(2). Operation noise distribution

LK-F (Height: 10 mm, Standard)

Measuring conditions
 Sample: LKF1aM-12V-1-5, 50pcs
 Background noise: approx. 20dB
 Coil voltage: 12V DC
 Equipment setting: "A" weighted
 Single part (refer to figure below)
 With diode

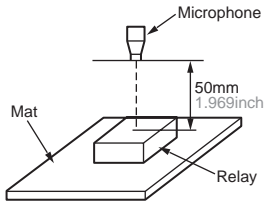

When operate

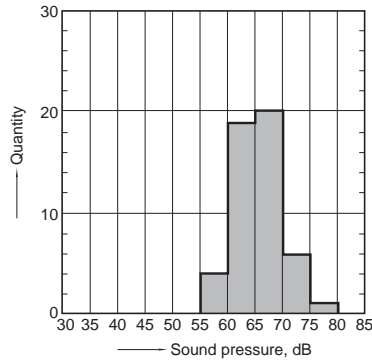

When release

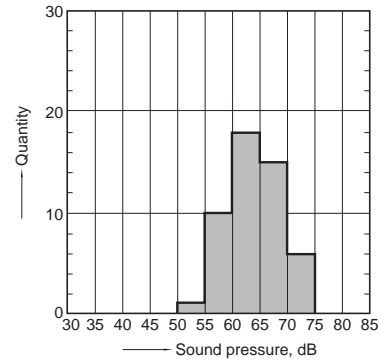

5-(3). Operation noise distribution

LK-S (Height: 25 mm) Refer to comparison

Measuring conditions
 Sample: LKS1aF-12V, 50pcs
 Background noise: approx. 20dB
 Coil voltage: 12V DC
 Equipment setting: "A" weighted
 Single part (refer to figure below)
 With diode

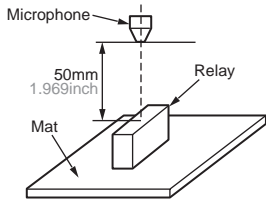

When operate

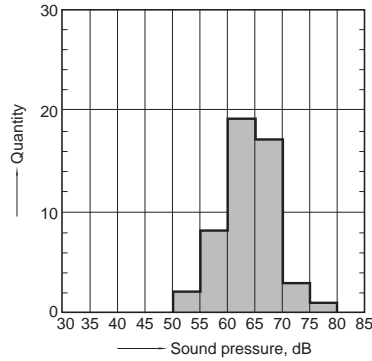

When release

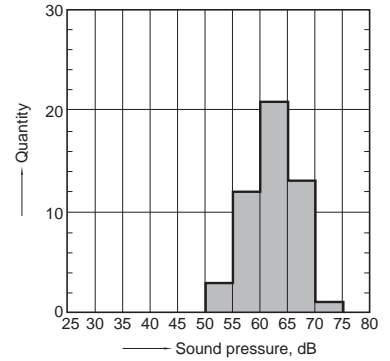

DIMENSIONS (Unit: mm inch)



External dimensions

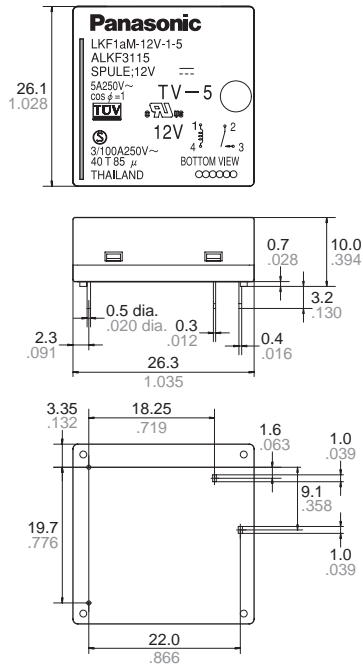

PC board pattern (Bottom view)

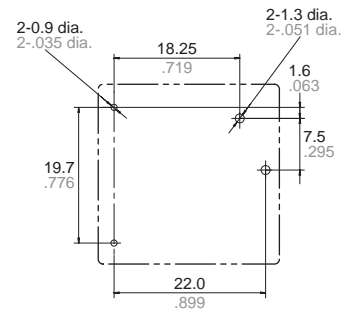

Schematic (Bottom view)



<u>Dimension:</u>	<u>General tolerance</u>
Max. 1mm .039 inch:	$\pm 0.1 \pm .004$
1 to 3mm .039 to .118 inch:	$\pm 0.2 \pm .008$
Min. 3mm .118 inch:	$\pm 0.3 \pm .012$

SAFETY STANDARDS

Certification authority	TV-5 type	TV-8 type
UL, C-UL	TV-5 5 A 277 V AC	TV-8 8 A 277 V AC
SEMKO	3/100 A 250 V AC 40T85 μ	
TÜV	EN61810-1 5 A 250 V AC (cos ϕ = 1.0)	EN61810-1 8 A 250 V AC (cos ϕ = 1.0)

NOTES

■ Usage, transport and storage conditions

1) Temperature:

–40 to +70°C –40 to +158°F

2) Humidity: 5 to 85% RH

(Avoid freezing and condensation.)

The humidity range varies with the temperature. Use within the range indicated in the graph below.

3) Atmospheric pressure: 86 to 106 kPa
Temperature and humidity range for usage, transport, and storage

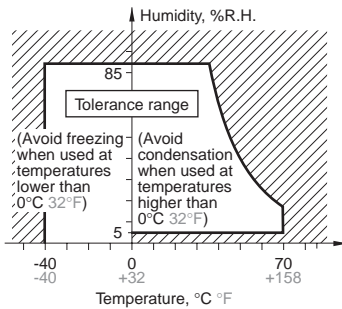

4) Condensation

Condensation forms when there is a sudden change in temperature under high temperature and high humidity conditions. Condensation will cause deterioration of the relay insulation.

5) Freezing

Condensation or other moisture may freeze on the relay when the temperatures is lower than 0°C 32°F.

This causes problems such as sticking of movable parts or operational time lags.

6) Low temperature, low humidity environments

The plastic becomes brittle if the relay is exposed to a low temperature, low humidity environment for long periods of time.

■ Solder and cleaning conditions

1) Please obey the following conditions when soldering automatically.

(1) Preheating: Within 120°C 248°F (solder surface terminal portion) and within 120 seconds

(2) Soldering iron: 260°C±5°C 500°F±41°F (solder temperature) and within 6 seconds (soldering time)

2) Since this is not a sealed type relay, do not clean it as is. Also, be careful not to allow flux to overflow above the PC board or enter the inside of the relay.

■ Certification

1) This relay is UL and C-UL certified.

UL and C-UL standards:

TV-5 5 A 277 V AC

TV-8 8 A 277 V AC

2) This relay is certified by TÜV as an electromagnetic relay that complies with EN61810-1.

TÜV standards:

TV-5 type 5 A 250 V~ $\cos\phi = 1.0$

TV-8 type 8 A 250 V~ $\cos\phi = 1.0$

3) This relay is certified by SEMKO.

3/100 A 250 V AC 40T85 μ

Steady-state current: 3A/Inrush current:

100 A, Load voltage: 250 V AC

Ambient temperature: –40 to +85°C –40 to +185°F, Micro-gap

■ Others

1) For precautions regarding use and explanations of technical terminology, please refer to our web site.

(panasonic-electric-works.net/ac)

2) To ensure good operation, please keep the voltage on the coil ends to $\pm 5\%$ (at 20°C 68°F) of the rated coil operation voltage. Also, please be aware that the pick-up voltage and drop-out voltage may change depending on the temperature and conditions of use.

3) Keep the ripple rate of the nominal coil voltage below 5%.

4) The cycle lifetime is defined under the standard test condition specified in the JIS C 5442 standard (temperature 15 to 35°C 59 to 95°F, humidity 25 to 75%). Check this with the real device as it is affected by coil driving circuit, load type, activation frequency, activation phase, ambient conditions and other factors. Also, be especially careful of loads such as those listed below.

(1) When used for AC load-operating and the operating phase is synchronous. Rocking and fusing can easily occur due to contact shifting.

(2) Highly frequent load-operating
When highly frequent opening and closing of the relay is performed with a load that causes arcs at the contacts, nitrogen and oxygen in the air is fused by the arc energy and HNO_3 is formed. This can corrode metal materials.

Three countermeasures for these are listed here.

- Incorporate an arc-extinguishing circuit.
- Lower the operating frequency
- Lower the ambient humidity

5) This value can change due to the switching frequency, environmental conditions, and desired reliability level, therefore it is recommended to check this with the actual load.

6) Heat, smoke, and even a fire may occur if the relay is used in conditions outside of the allowable ranges for the coil ratings, contact ratings, operating cycle lifetime, and other specifications. Therefore, do not use the relay if these ratings are exceeded.

7) If the relay has been dropped, the appearance and characteristics should always be checked before use.

8) Incorrect wiring may cause unexpected events or the generation of heat or flames.

9) The amount of relay operation noise will vary depending on the substrate used for mounting. Please use after verifying with the relay mounted on the substrate.

10) There are no restrictions as to how this relay should be oriented during installation. However, due to gravitation there may be slight differences in pick-up/drop-out voltage and operate/release time, etc., depending on the orientation. Therefore, when evaluating the relay, please do so with the relay installed with the actual orientation.

For Cautions for Use, see [Relay Technical Information](#).