



DC COMPONENTS CO., LTD.

RECTIFIER SPECIALISTS

SF51
THRU
SF58

TECHNICAL SPECIFICATIONS OF SUPER FAST RECTIFIER

VOLTAGE RANGE - 50 to 600 Volts

CURRENT- 5.0 Amperes

FEATURES

- * High reliability
- * Low leakage
- * Low forward voltage
- * High current capability
- * Super fast switching speed
- * High surge capability
- * Good for switching mode circuit

MECHANICAL DATA

- * Case: Molded plastic
- * Epoxy: UL 94V-0 rate flame retardant
- * Lead: MIL-STD-202E, Method 208 guaranteed
- * Mounting position: Any
- * Weight: 1.18 grams

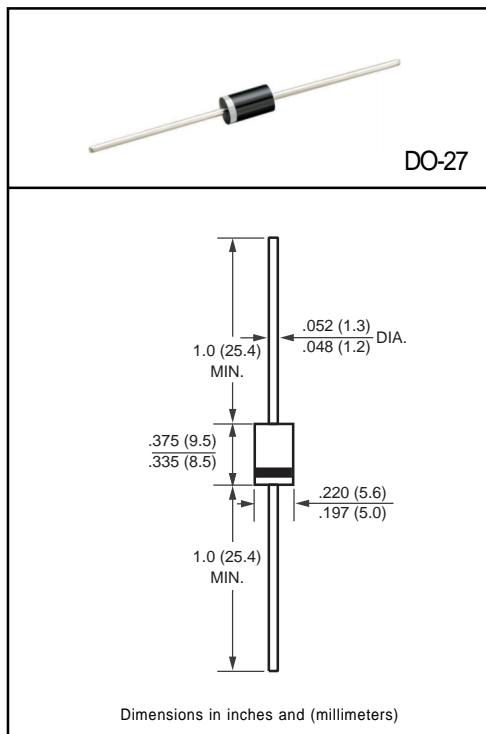

DO-27

Dimensions in inches and (millimeters)

MAXIMUM RATINGS AND ELECTRICAL CHARACTERISTICS

Ratings at 25 °C ambient temperature unless otherwise specified.

Single phase, half wave, 60 Hz, resistive or inductive load.

For capacitive load, derate current by 20%.

	SYMBOL	SF51	SF52	SF53	SF54	SF55	SF56	SF58	UNITS	
Maximum Recurrent Peak Reverse Voltage	V _{RRM}	50	100	150	200	300	400	600	Volts	
Maximum RMS Voltage	V _{RMS}	35	70	105	140	210	280	420	Volts	
Maximum DC Blocking Voltage	V _{DC}	50	100	150	200	300	400	600	Volts	
Maximum Average Forward Rectified Current at T _A = 55°C	I _O	5.0							Amps	
Peak Forward Surge Current 8.3 ms single half sine-wave superimposed on rated load (JEDEC Method)	I _{FSM}	150							Amps	
Maximum Instantaneous Forward Voltage at 5.0A DC	V _F	0.95			1.40		1.85		Volts	
Maximum DC Reverse Current at Rated DC Blocking Voltage	I _R	@ T _A = 25°C							μAmps	
		@ T _A = 125°C							μAmps	
Maximum Reverse Recovery Time (Note 1)	t _{rr}	35							nSec	
Typical Junction Capacitance (Note 2)	C _J	50				30				pF
Operating and Storage Temperature Range	T _J , T _{STG}	-65 to +150							°C	

NOTES: 1. Test Conditions: I_F = 0.5A, I_R = 1.0A, I_{RR} = 0.25A

2. Measured at 1 MHz and applied reverse voltage of 4.0 volts.

RATING AND CHARACTERISTIC CURVES (SF51 THRU SF58)

FIG. 1 - TEST CIRCUIT DIAGRAM AND REVERSE RECOVERY TIME CHARACTERISTIC

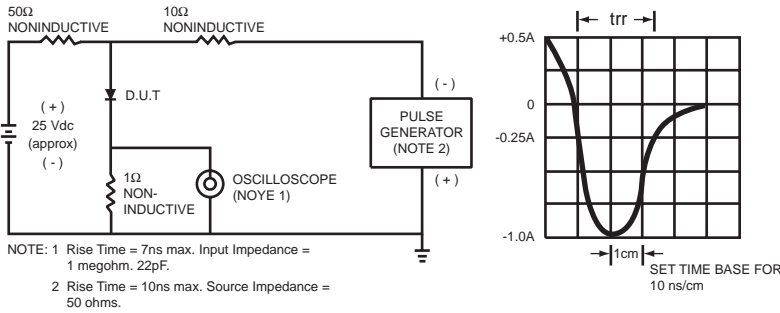

FIG. 2 - TYPICAL FORWARD CURRENT DERATING CURVE

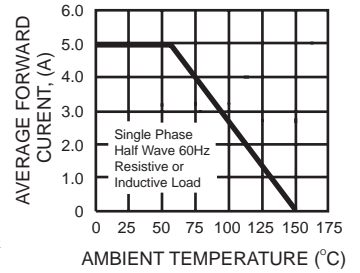

FIG. 3 - TYPICAL REVERSE CHARACTERISTICS

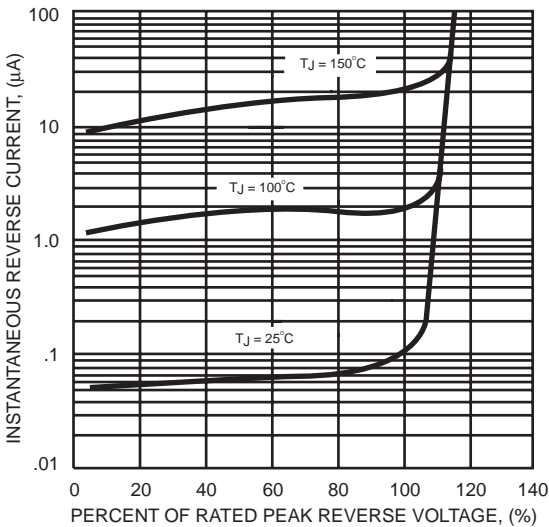

FIG. 4 - TYPICAL INSTANTANEOUS FORWARD CHARACTERISTICS

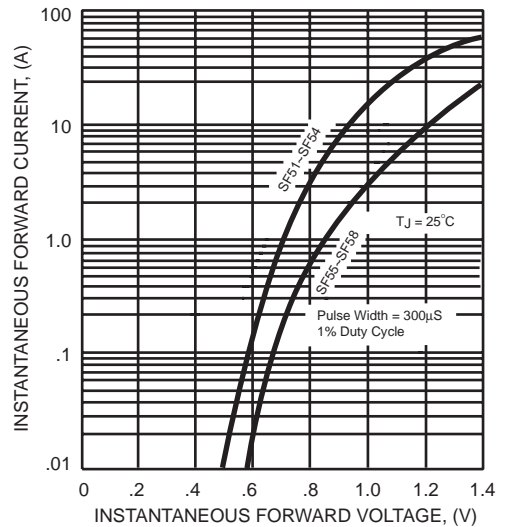

FIG. 5 - MAXIMUM NON-REPETITIVE FORWARD SURGE CURRENT

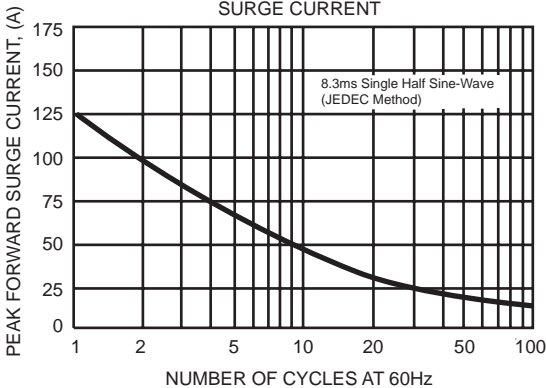
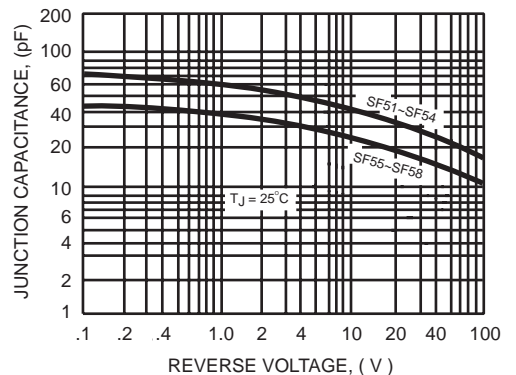

FIG. 6 - TYPICAL JUNCTION CAPACITANCE



DC COMPONENTS CO., LTD.