

Item No. : X98088

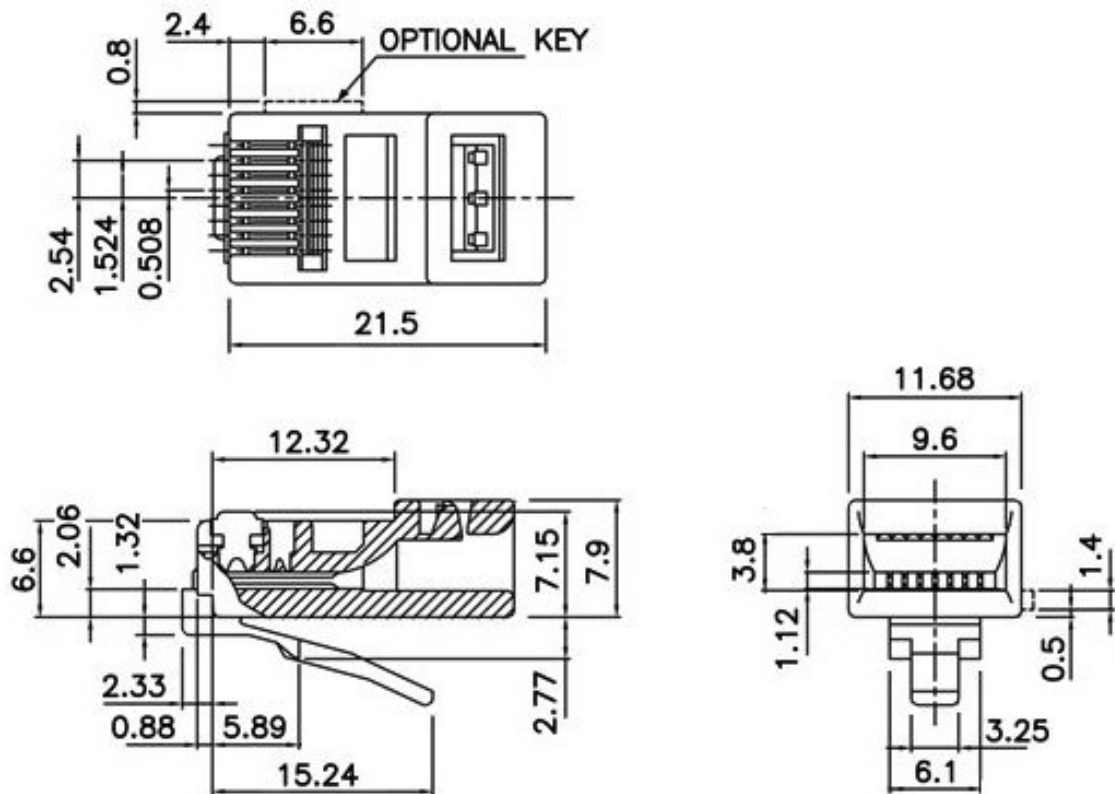

Materials

Housing: Polycarbonate UL94-V0 or 94-V2, clear.

Contacts: Phosphor bronze 0.35t

Plate: Gold plated on contact area over 100 microinch min. Nickel underplate overall.