

DATA SHEET

SURFACE-MOUNT CERAMIC MULTILAYER CAPACITORS

Class 2, Z5U
25/50 V

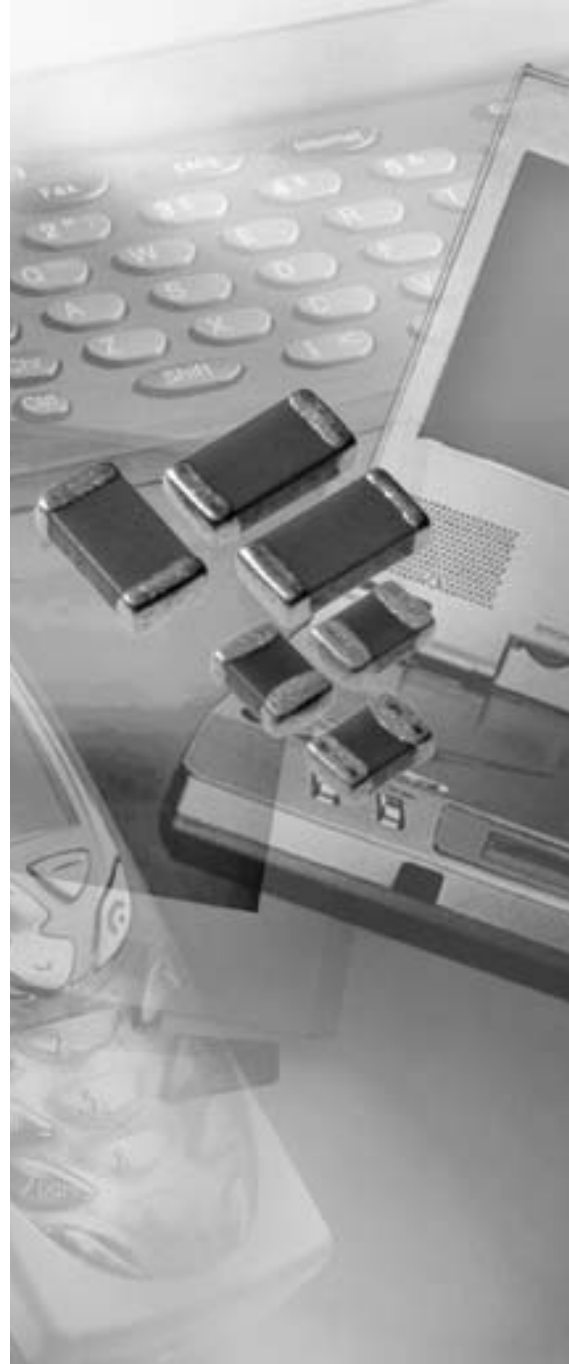

Surface-mount ceramic multilayer capacitors

**Class 2, Z5U
25/50 V**

FEATURES

- Four standard sizes
- For high frequency applications
- Supplied in tape on reel
- Nickel-barrier end terminations.

APPLICATIONS

- Tuners
- Television receivers
- Video recorders
- All types of cameras
- Telecommunications
- Automotive
- Data processing.

DESCRIPTION

The capacitor consists of a rectangular block of ceramic dielectric in which a number of interleaved metal electrodes are contained. This structure gives rise to a high capacitance per unit volume.

The inner electrodes are connected to the two terminations and finally covered with a layer of plated tin (NiSn). A cross section of the structure is shown in Fig.1.

QUICK REFERENCE DATA

DESCRIPTION	VALUE
Rated voltage U_R (DC)	25 V, 50 V
Capacitance range (E3 series):	10 nF to 470 nF
Tolerance on capacitance after 1000 hours	$\pm 20\%$ (M); -20% to $+80\%$ (Z)
Test voltage (DC) for 1 minute	$2.5 \times U_R$
Sectional specifications	IEC 60 384-10, second edition 1989-04; also based on CECC 32 100
Detailed specification	based on CECC 32 101-801
Climatic category (IEC 60068)	10/85/21

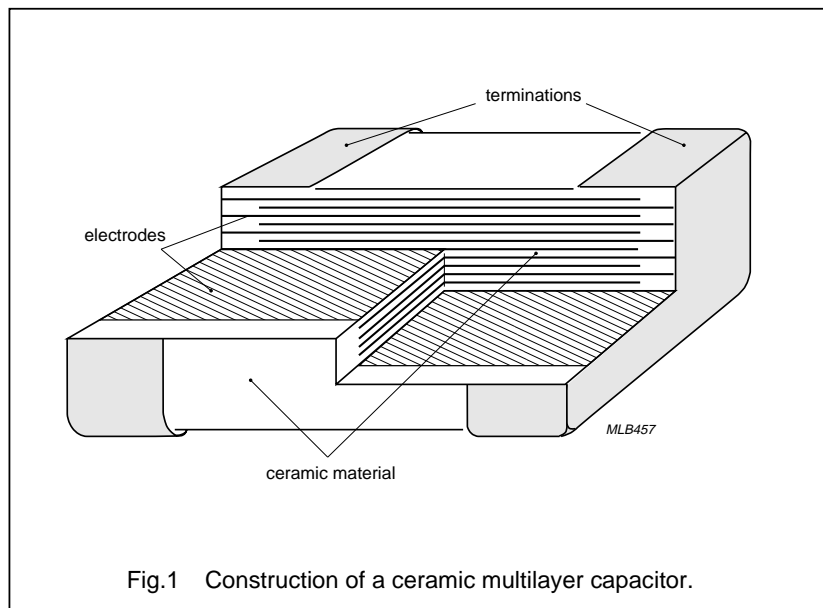
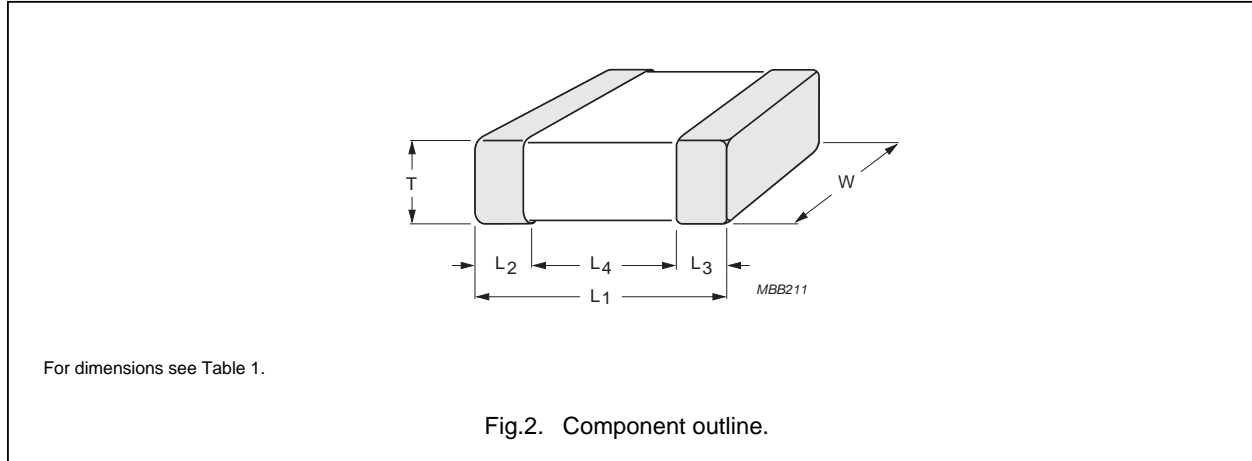

Fig.1 Construction of a ceramic multilayer capacitor.

Surface-mount ceramic multilayer capacitors

Class 2, Z5U 25/50 V

MECHANICAL DATA



Physical dimensions

Table 1 Capacitor dimensions

CASE SIZE	L ₁	W	T		L ₂ and L ₃		L ₄ MIN.
			MIN.	MAX.	MIN.	MAX.	
Dimensions in millimetres							
0603	1.6 ±0.10	0.8 ±0.07	0.73	0.87	0.25	0.65	0.40
0805	2.0 ±0.1	1.25 ±0.1	0.50	1.35	0.25	0.75	0.55
1206	3.2 ±0.15	1.6 ±0.15	0.50	1.25	0.25	0.75	1.40
1210	3.2 ±0.20	2.5 ±0.20	0.50	1.30	0.25	0.75	1.40
Dimensions in inches							
0603	0.063 ±0.004	0.032 ±0.003	0.029	0.035	0.010	0.026	0.016
0805	0.079 ±0.004	0.049 ±0.004	0.020	0.053	0.010	0.030	0.022
1206	0.126 ±0.006	0.063 ±0.006	0.020	0.049	0.010	0.030	0.056
1210	0.126 ±0.008	0.098 ±0.008	0.020	0.051	0.010	0.030	0.056

Surface-mount ceramic multilayer capacitors

Class 2, Z5U 25/50 V

SELECTION CHART

C (nF)	LAST TWO DIGITS OF 12NC	25 V	50 V		
		0603	0805	1206	1210
10	36				
22	41	0.80 ±0.07	0.60 ±0.10		
47	45			0.60 ±0.10	
100	49				
220	54				0.50 to 1.0
470	58				

Note

- Values in shaded cells indicate thickness class.

Thickness classification and packing quantities

THICKNESS CLASSIFICATION (mm)	8 mm TAPE WIDTH QUANTITY PER REEL				QUANTITY PER BULK CASE	
	Ø180 mm; 7"		Ø330 mm; 13"		0603	0805
	PAPER	BLISTER	PAPER	BLISTER		
0.60 ±0.10	4 000	–	20 000	–	–	10 000
0.80 ±0.07	4 000	–	15 000	–	15 000	–
0.50 to 1.0	–	4 000	–	10 000	–	–

Surface-mount ceramic multilayer capacitors

Class 2, Z5U 25/50 V

ORDERING INFORMATION

Components may be ordered by using either Phycomp's unique 12NC or a simple 15-digit clear text code.

Ordering code 12NC (preferred)

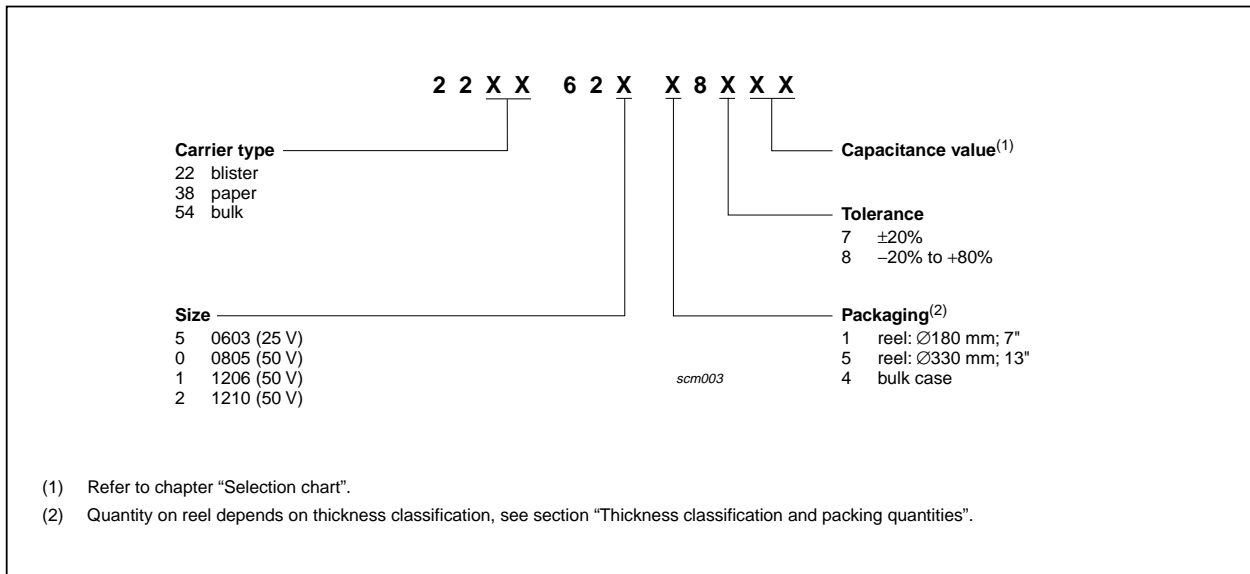

Clear text code

EXAMPLE: 12062E104M9B20D

Size Code	Temp. Char.	Capacitance	Tol.	Vol.	Termination	Packing	Marking	Series
0603 0805 1206 1210	2E = Z5U	104=1000000 pF; the third digit signifies the number of zeros	M = ±20% Z = -20%/+80%	8 = 25V 9 = 50V	B = NiSn	2 = 180 mm; 7" paper 3 = 330 mm; 13" paper B = 180 mm; 7" blister F = 330 mm; 13" blister P = bulk case	0 = no marking	D = BME

Surface-mount ceramic multilayer capacitors

Class 2, Z5U 25/50 V

ELECTRICAL CHARACTERISTICS

Class 2 capacitors; Z5U dielectric; NiSn terminations

Unless otherwise stated all electrical values apply at an ambient temperature of 25 ± 1 °C, an atmospheric pressure of 86 to 105 kPa, and a relative humidity of 63 to 67%.

DESCRIPTION	VALUE	
	25 V	50 V
Capacitance range (E3 series); note 1		
case size 0603	10 nF to 100 nF	–
case size 0805	–	10 nF to 100 nF
case size 1206	–	10 nF to 220 nF
case size 1210	–	100 nF 470 nF
Tolerance on capacitance after 1000 hours	$\pm 20\%$ (M); -20% / $+80\%$ (Z)	
Tan δ ; note 1	$\leq 4\%$	
Insulation resistance after 1 minute at U_R (DC)	$R_{ins} > 10 \text{ G}\Omega$ or $R_{ins} \times C > 1000$ seconds, whichever is smaller	
Maximum capacitance change with respect to capacitance at 25 °C (for typical values see Fig.5)	$+22\%$ to -56%	
Ageing per time decade	4%	3%
Resistance to soldering heat	260 °C; 10 seconds	

Note

1. Measured at 25 °C, $0.5 V_{rms}$ and 1 kHz, using a four-gauge method.

Surface-mount ceramic multilayer capacitors

Class 2, Z5U 25/50 V

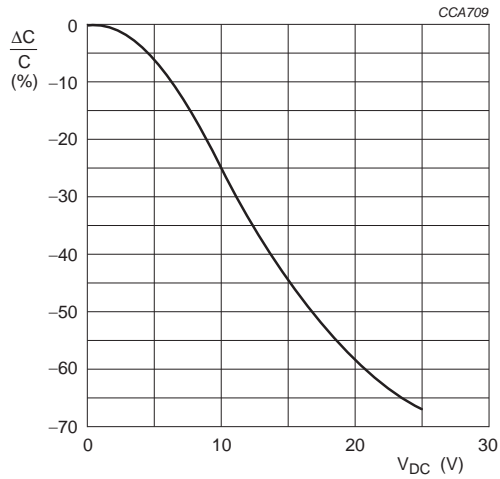

Fig.3 Typical capacitance change with respect to the capacitance at 1 V as a function of DC voltage at 25 °C.

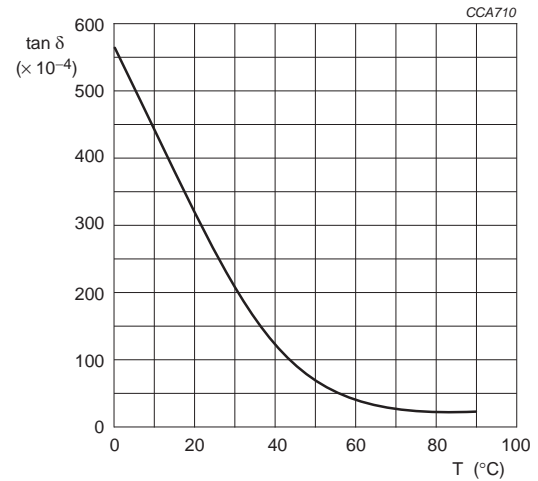

Fig.4 Typical tan δ as a function of temperature.

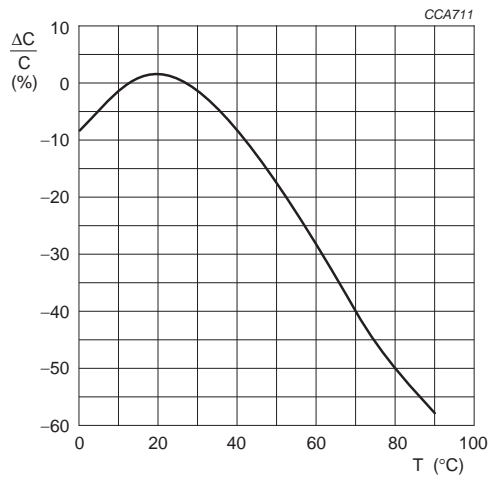

Fig.5 Typical capacitance change as a function of temperature.

Surface-mount ceramic multilayer capacitors

Class 2, Z5U 25/50 V

TESTS AND REQUIREMENTS

Table 2 Test procedures and requirements

IEC 60384-10/ CECC 32 100 CLAUSE	IEC 60068-2 TEST METHOD	TEST	PROCEDURE	REQUIREMENTS
4.4		mounting	the capacitors may be mounted on printed-circuit boards or ceramic substrates by applying wave soldering, reflow soldering (including vapour phase soldering) or conductive adhesive	no visible damage
4.5		visual inspection and dimension check	any applicable method using $\times 10$ magnification	in accordance with specification
4.6.1		capacitance	$f = 1 \text{ kHz}$; measuring voltage $0.5 V_{\text{rms}}$ at $25 \text{ }^\circ\text{C}$	within specified tolerance measured 1000 hours after date of manufacture
4.6.2		$\tan \delta$	$f = 1 \text{ kHz}$; measuring voltage $0.5 V_{\text{rms}}$ at $25 \text{ }^\circ\text{C}$	in accordance with specification
4.6.3		insulation resistance	at U_{R} (DC) for 1 minute	in accordance with specification
4.6.4		voltage proof	$2.5 \times U_{\text{R}}$ for one minutes max.	no breakdown or flashover
4.7.1		temperature characteristic	$10 \text{ to } 85 \text{ }^\circ\text{C}$	$\Delta C/C$: $+22\%$ to -56% at $25 \text{ }^\circ\text{C}$
4.8		adhesion	a force of 5 N applied for 10 s to the line joining the terminations and in a plane parallel to the substrate	no visible damage
4.9		bond strength of plating on end face	mounted in accordance with CECC 32 100, paragraph 4.4	no visible damage
			conditions: bending 1 mm at a rate of 1 mm/s, radius jig 340 mm	$\Delta C/C$: $\pm 30\%$

**Surface-mount ceramic
multilayer capacitors**
**Class 2, Z5U
25/50 V**

IEC 60384-10/ CECC 32 100 CLAUSE	IEC 60068-2 TEST METHOD	TEST	PROCEDURE	REQUIREMENTS
4.10	Tb	resistance to soldering heat	260 ±5 °C for 10 ±0.5 s in a static solder bath	the terminations shall be well tinned after recovery ΔC/C: ±20% tan δ: original specification R _{ins} : original specification
		resistance to leaching	260 ±5 °C for 30 ±1 s in a static solder bath	using visual enlargement of ×10, dissolution of the terminations shall not exceed 10%
4.11	Ta	solderability	zero hour test, and test after storage (20 to 24 months) in original packing in normal atmosphere; unmounted chips completely immersed for 2 ±0.5 s in a solder bath at 235 ±5 °C	the terminations shall be well tinned
4.14	Ca	damp heat	initialization: 150 °C for 1 hour, recovery 48 ±4 hours at 40 °C; 90 to 95% RH; U _R applied for 500 hours	ΔC/C: ±30% tan δ: 6% max. R _{ins} : 1000 MΩ or R _i C _R ≥ 100 s, whichever is less
4.15		endurance	initialization: 2 × U _R at 85 × C for 1 hour (initial value) is measured after 48 ±4 hours; 2 × U _R at 85 °C for 42 days, recovery 48 ±4 hours at room temperature	after 48 hours recovery: ΔC/C: ±30% tan δ: 6% max. R _{ins} : 1000 MΩ or R _i C _R ≥ 100 s, whichever is less

**Surface-mount ceramic
multilayer capacitors****Class 2, Z5U
25/50 V****REVISION HISTORY**

Revision	Date	Change Notification	Description
Rev.4	2001 Mar 30	-	- Converted to Phycomp brand - Capacitance range changed from E12 to E3 series.
		22/02/2001	- 470 nF 1206 no longer supported.
Rev.5	2003 Jan 07	-	- Combined 25V and 50V data sheets - Updated company logo
Rev.6	2003 Jul 08	-	- 1206 size 25V phase out - 0805 220nF 50V phase out - 1210 1uF 50V phase out