

## SIPMOS<sup>®</sup> Small-Signal Transistor

- P channel
- Enhancement mode
- Logic Level
- $V_{GS(th)} = -0.8...-2.0$  V

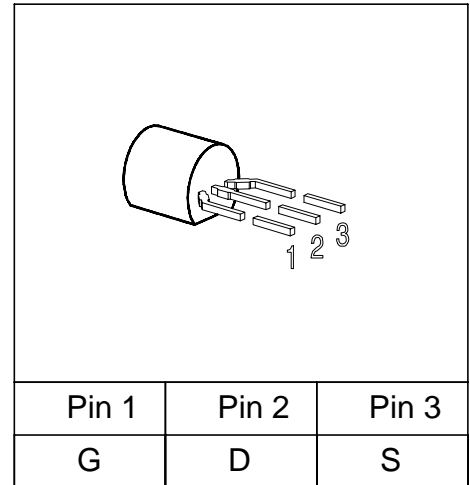

Type	$V_{DS}$	$I_D$	$R_{DS(on)}$	Package	Marking
BSS 92	-240 V	-0.15 A	20 $\Omega$	TO-92	SS92

Type	Ordering Code	Tape and Reel Information
BSS 92	Q62702-S497	E6288
BSS 92	Q62702-S633	E6296
BSS 92	Q62702-S502	E6325

### Maximum Ratings

Parameter	Symbol	Values	Unit
Drain source voltage	$V_{DS}$	-240	V
Drain-gate voltage $R_{GS} = 20$ k $\Omega$	$V_{DGR}$	-240	
Gate source voltage	$V_{GS}$	$\pm 20$	
Continuous drain current $T_A = 33$ °C	$I_D$	-0.15	A
DC drain current, pulsed $T_A = 25$ °C	$I_{Dpuls}$	-0.6	
Power dissipation $T_A = 25$ °C	$P_{tot}$	1	W

## Maximum Ratings

Parameter	Symbol	Values	Unit
Chip or operating temperature	$T_j$	-55 ... + 150	°C
Storage temperature	$T_{stg}$	-55 ... + 150	
Thermal resistance, chip to ambient air <sup>1)</sup>	$R_{thJA}$	≤ 125	K/W
DIN humidity category, DIN 40 040		E	
IEC climatic category, DIN IEC 68-1		55 / 150 / 56	

## Electrical Characteristics, at $T_j = 25^\circ\text{C}$ , unless otherwise specified

Parameter	Symbol	Values			Unit
		min.	typ.	max.	

## Static Characteristics

Drain- source breakdown voltage $V_{GS} = 0 \text{ V}$ , $I_D = -0.25 \text{ mA}$ , $T_j = 25 \text{ }^\circ\text{C}$	$V_{(BR)DSS}$	-240	-	-	V	
Gate threshold voltage $V_{GS}=V_{DS}$ , $I_D = -1 \text{ mA}$	$V_{GS(th)}$	-0.8	-1.5	-2		
Zero gate voltage drain current $V_{DS} = -240 \text{ V}$ , $V_{GS} = 0 \text{ V}$ , $T_j = 25 \text{ }^\circ\text{C}$ $V_{DS} = -240 \text{ V}$ , $V_{GS} = 0 \text{ V}$ , $T_j = 125 \text{ }^\circ\text{C}$ $V_{DS} = -60 \text{ V}$ , $V_{GS} = 0 \text{ V}$ , $T_j = 25 \text{ }^\circ\text{C}$	$I_{DSS}$	-	-0.1 -10 -	-1 -100 -0.2	$\mu\text{A}$	
Gate-source leakage current $V_{GS} = -20 \text{ V}$ , $V_{DS} = 0 \text{ V}$	$I_{GSS}$	-	-10	-100		nA
Drain-Source on-state resistance $V_{GS} = -10 \text{ V}$ , $I_D = -0.15 \text{ A}$	$R_{DS(on)}$	-	10	20		$\Omega$

**Electrical Characteristics**, at  $T_j = 25^\circ\text{C}$ , unless otherwise specified

Parameter	Symbol	Values			Unit
		min.	typ.	max.	

**Dynamic Characteristics**

Transconductance $V_{DS} \geq 2 \cdot I_D \cdot R_{DS(on)max}$ , $I_D = -15 \text{ A}$	$g_{fs}$	0.06	0.12	-	S
Input capacitance $V_{GS} = 0 \text{ V}$ , $V_{DS} = -25 \text{ V}$ , $f = 1 \text{ MHz}$	$C_{iss}$	-	95	130	pF
Output capacitance $V_{GS} = 0 \text{ V}$ , $V_{DS} = -25 \text{ V}$ , $f = 1 \text{ MHz}$	$C_{oss}$	-	20	30	
Reverse transfer capacitance $V_{GS} = 0 \text{ V}$ , $V_{DS} = -25 \text{ V}$ , $f = 1 \text{ MHz}$	$C_{rss}$	-	10	15	
Turn-on delay time $V_{DD} = -30 \text{ V}$ , $V_{GS} = -10 \text{ V}$ , $I_D = -0.25 \text{ A}$ $R_G = 50 \Omega$	$t_{d(on)}$	-	8	12	ns
Rise time $V_{DD} = -30 \text{ V}$ , $V_{GS} = -10 \text{ V}$ , $I_D = -0.25 \text{ A}$ $R_G = 50 \Omega$	$t_r$	-	25	40	
Turn-off delay time $V_{DD} = -30 \text{ V}$ , $V_{GS} = -10 \text{ V}$ , $I_D = -0.25 \text{ A}$ $R_G = 50 \Omega$	$t_{d(off)}$	-	25	33	
Fall time $V_{DD} = -30 \text{ V}$ , $V_{GS} = -10 \text{ V}$ , $I_D = -0.25 \text{ A}$ $R_G = 50 \Omega$	$t_f$	-	42	55	

**Electrical Characteristics, at  $T_j = 25^\circ\text{C}$ , unless otherwise specified**

Parameter	Symbol	Values			Unit
		min.	typ.	max.	

**Reverse Diode**

Inverse diode continuous forward current $T_A = 25^\circ\text{C}$	$I_S$	-	-	-0.15	A
Inverse diode direct current, pulsed $T_A = 25^\circ\text{C}$	$I_{SM}$	-	-	-0.6	
Inverse diode forward voltage $V_{GS} = 0\text{ V}, I_F = -0.3\text{ A}$	$V_{SD}$	-	-0.85	-1.2	V

### Power dissipation

$$P_{\text{tot}} = f(T_A)$$

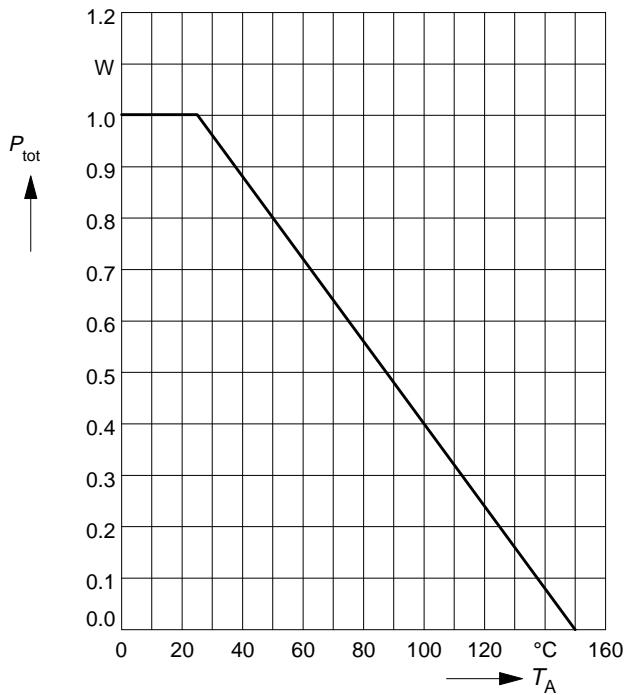

### Drain current

$$I_D = f(T_A)$$

parameter:  $V_{GS} \geq -10$  V

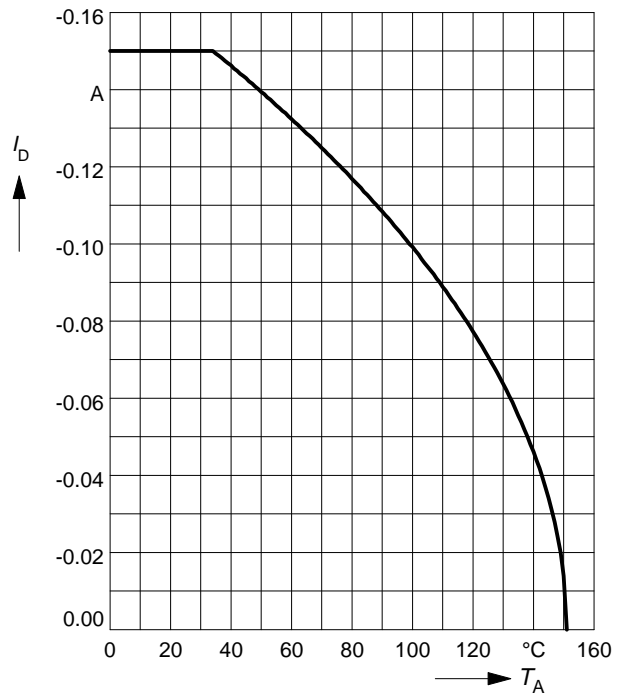

### Safe operating area $I_D = f(V_{DS})$

parameter:  $D = 0.01$ ,  $T_C = 25^\circ\text{C}$

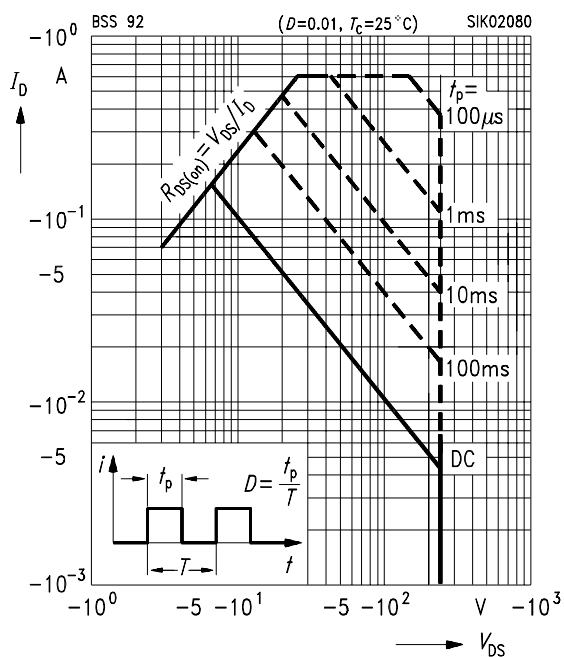

### Drain-source breakdown voltage

$$V_{(BR)DSS} = f(T_j)$$

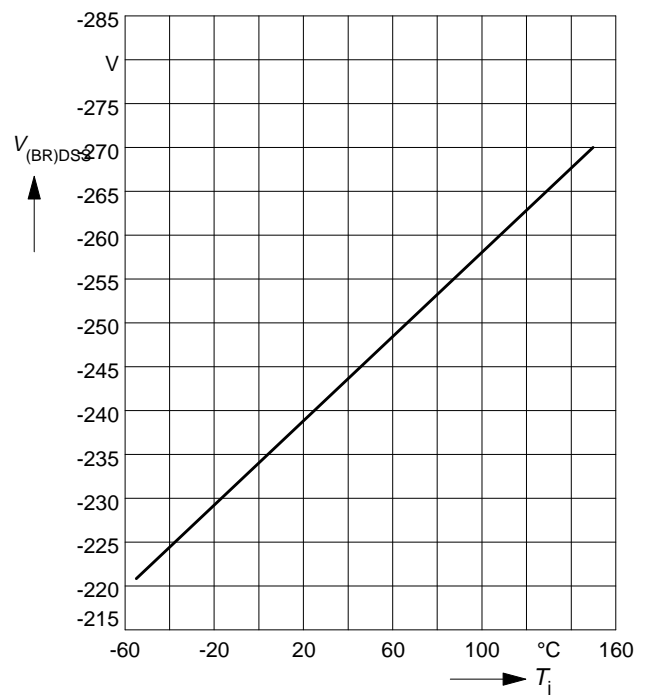

### Typ. output characteristics

$$I_D = f(V_{DS})$$

parameter:  $t_p = 80 \mu s$ ,  $T_j = 25 \text{ }^\circ\text{C}$

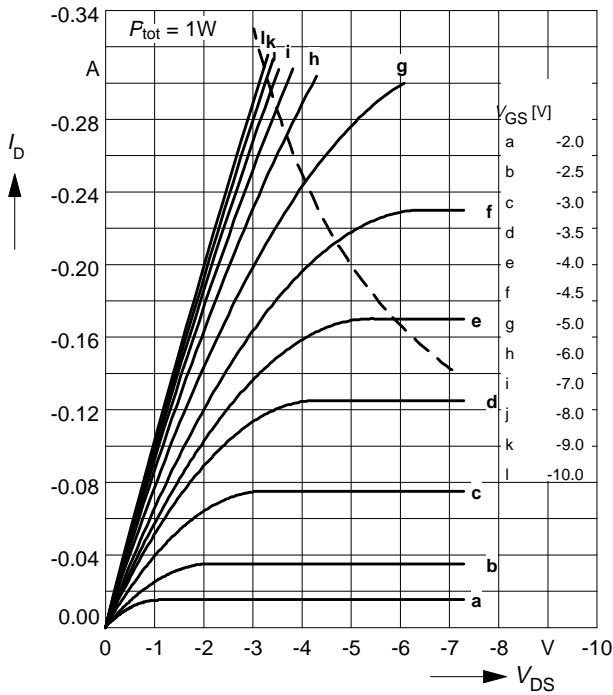

### Typ. drain-source on-resistance

$$R_{DS(on)} = f(I_D)$$

parameter:  $t_p = 80 \mu s$ ,  $T_j = 25 \text{ }^\circ\text{C}$

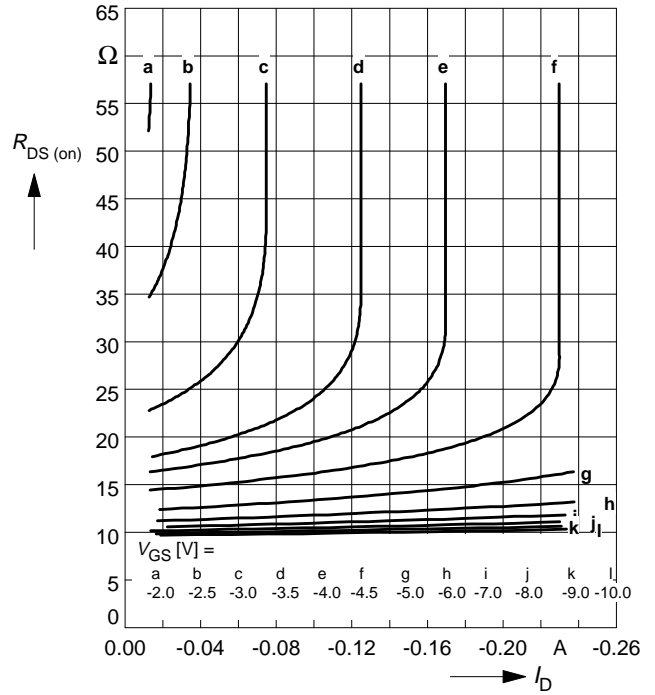

### Typ. transfer characteristics $I_D = f(V_{GS})$

parameter:  $t_p = 80 \mu s$

$V_{DS} \geq 2 \times I_D \times R_{DS(on)max}$

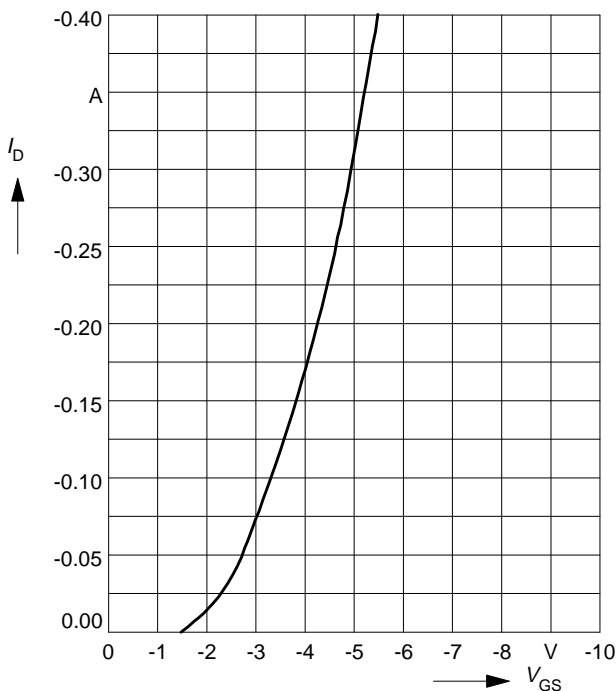

### Typ. forward transconductance $g_{fs} = f(I_D)$

parameter:  $t_p = 80 \mu s$ ,

$V_{DS} \geq 2 \times I_D \times R_{DS(on)max}$

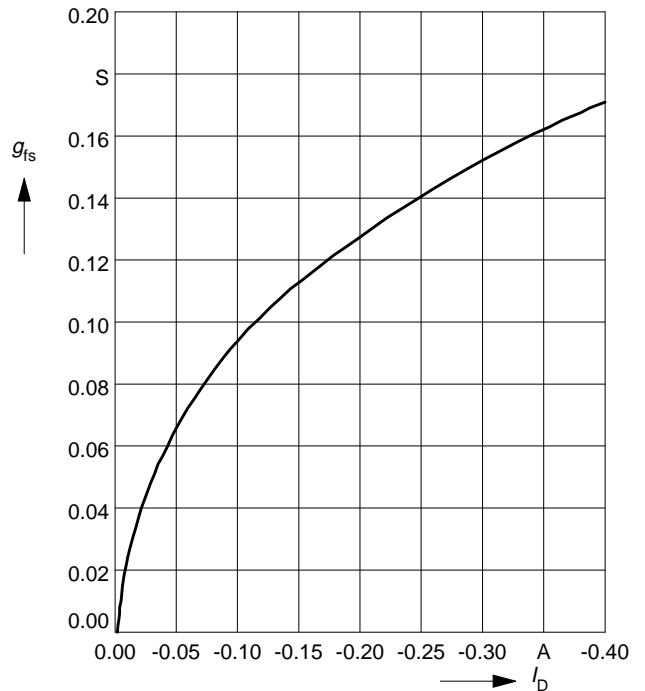

### Drain-source on-resistance

$$R_{DS(on)} = f(T_j)$$

parameter:  $I_D = -0.15 \text{ A}$ ,  $V_{GS} = -10 \text{ V}$

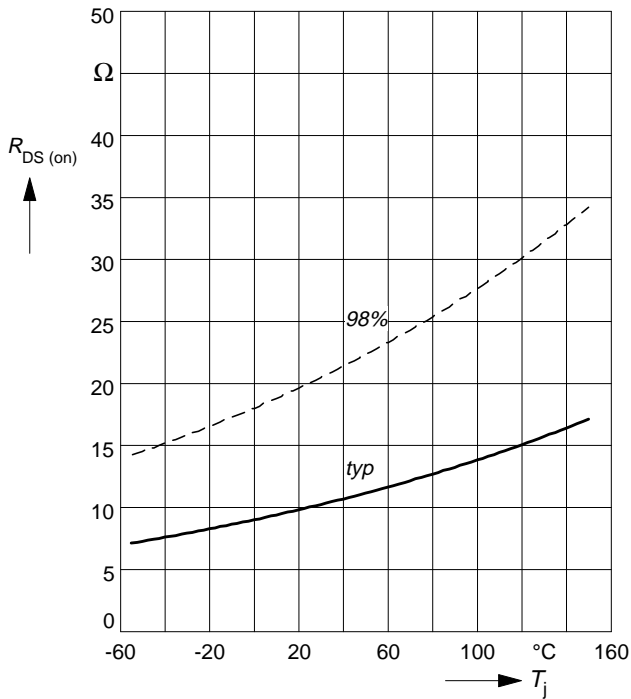

### Gate threshold voltage

$$V_{GS(th)} = f(T_j)$$

parameter:  $V_{GS} = V_{DS}$ ,  $I_D = -1 \text{ mA}$

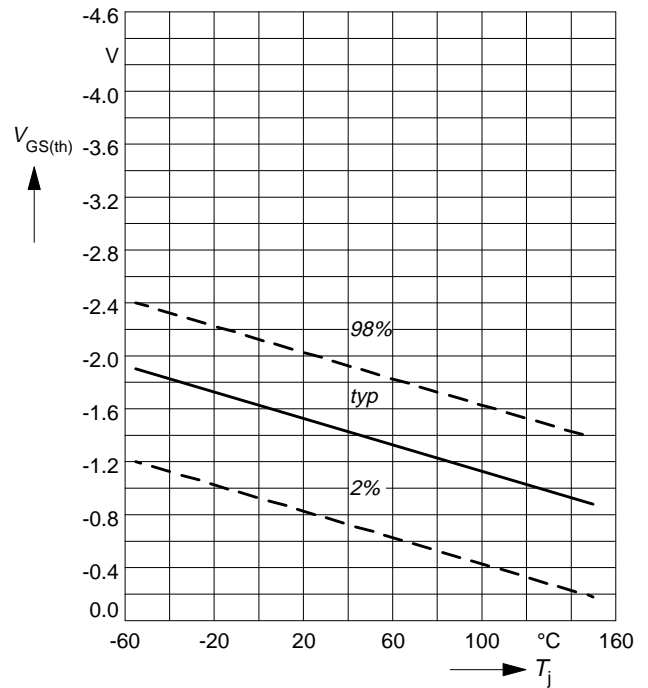

### Typ. capacitances

$$C = f(V_{DS})$$

parameter:  $V_{GS}=0\text{V}$ ,  $f = 1 \text{ MHz}$

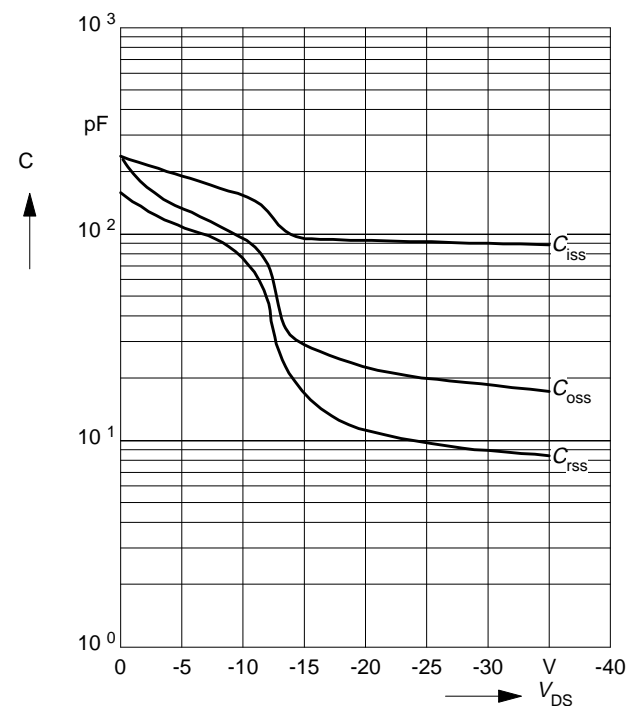

### Forward characteristics of reverse diode

$$I_F = f(V_{SD})$$

parameter:  $T_j, t_p = 80 \mu\text{s}$

