

1

2

3

4

5

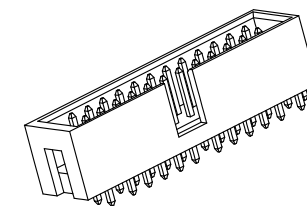
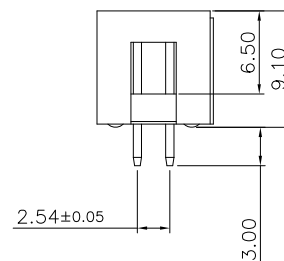
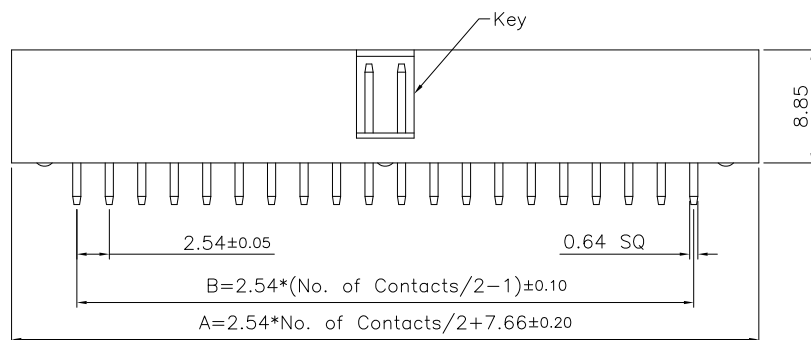
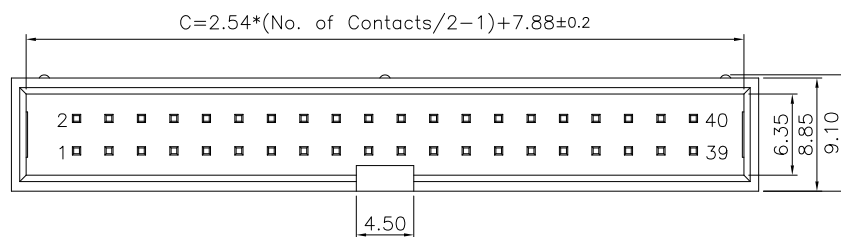

Specifications:

Current Rating:3.0A AC/DC

Voltage Rating:250V AC/DC

Contact Resistance:20m ohm. Max.

Insulation Resistance:1,000M ohm. Min.

Withstanding Voltage:600V AC For One Minute

Operating Temperature Range:-40°C ~ +105°C

Material and Finish

Insulator: PBT (UL94V-0)

Insulator Color:Black

Contact:Copper Alloy

Finish:Gold Plated

How To Order

△ 2316S-XXG-XX

Blank 6~40 Pin With One Key

1K: 50~64 Pin With One Key

3K: 50~64 Pin With Three Key

Gold Plated

No.of Positions

Straight



Notes:

No. Of Positions 50~64 With Three Key

All Other Pin With One Key

Pos	Dim A	Dim B	Dim C	Pos	Dim A	Dim B	Dim C	Pos	Dim A	Dim B	Dim C	Note
6	15.28	5.08	12.96	16	27.98	17.78	25.66	34	50.84	40.64	48.52	
8	17.82	7.62	15.50	20	33.06	22.86	30.74	40	58.46	48.26	56.14	
10	20.36	10.16	18.04	24	38.14	27.94	35.82	50	71.16	60.96	68.84	1K&3K
12	22.90	12.70	20.58	26	40.68	30.48	38.36	60	83.86	73.66	81.54	1K&3K
14	25.44	15.24	23.12	30	45.76	35.56	43.44	64	88.94	78.74	86.62	1K&3K

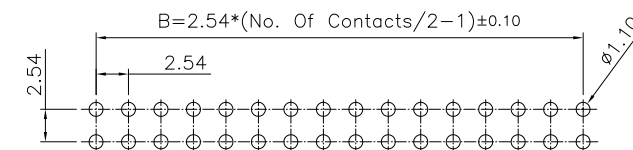

PCB Layout

RoHS Compliant

REV	DATE	FILE	BY	DRAWN:	CHECKED:	APPROVAL:	GENERAL TOLERANCE:	UNIT:	SCALE:	SHEET:	PROJECTION:	DESCRIPTION:	PART NO:	SIZE
F				Andy			.X=±0.20 .XX=±0.15	MM	1:1	1/2				
E														
D	19-MAR-2020	△(P0001)(PC0621)	Lisy											
C	06-OCT-2009	ECN-TW091001	Allen											
B	05-JUN-2008	ECN-CN080607	Yangxia											
A	29-MAR-2005	New Mold	Andy											
REV	DATE	FILE	BY	Andy	Jeremy Liu	Mike Wu								

Neltron Industrial Co., Ltd.

 DESCRIPTION:
2.54mm Box Header Straight Type

 PART NO:
2316S-XXG-XX △

SIZE

A4

D

1

2

3

4

5

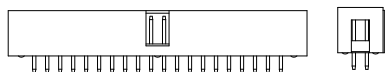
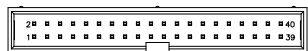

2316S-XXG-XX

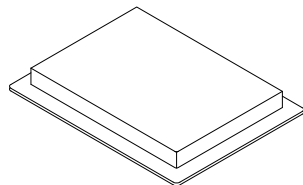

Tray

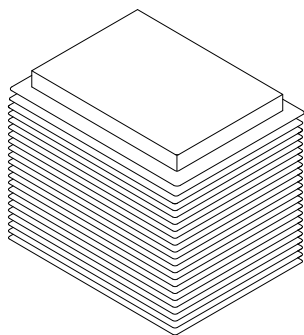

25Trays

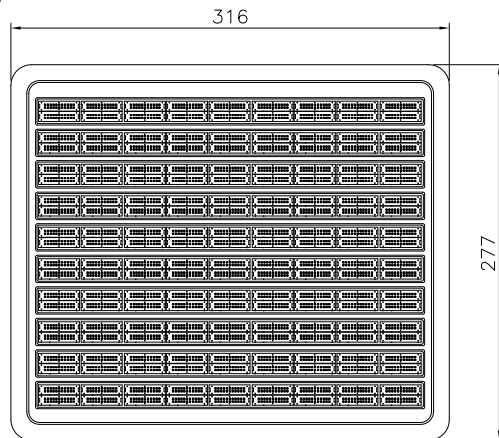

TRAY LAYOUT 902-2316R

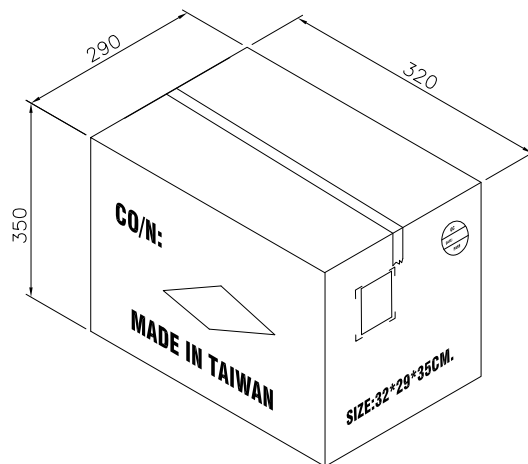

Carton

Note:

1.Dimension:

Tray Size: 316(L)x277(W)x13(H) (mm)

Carton Size: 320(L)x290(W)x350(H) (mm)

2.Quantity:

25Trays/Carton

Circuits	Pcs/Tray	Trays/Carton	Q'TY
06	360	25	9000
08	300	25	7500
10	260	25	6500
12	240	25	6000
14	200	25	5000
16	180	25	4500
20	160	25	4000
24	140	25	3500
26	120	25	3000
30	120	25	3000
34	100	25	2500
40	80	25	2000
44	80	25	2000
50	60	25	1500
60	60	25	1500
64	60	25	1500

RoHS Compliant

F				DRAWN: Andy	GENERAL TOLERANCE: .X=±0.20 .XX=±0.15	Neltron Industrial Co., Ltd.	DESCRIPTION: 2.54mm Box Header Straight Type Packing List	SIZE A4
E								
D	19-MAR-2020	(P0001)(PC0621)	Lisy	CHECKED: Jeremy Liu	UNIT: MM	PART NO: 2316S-XXG-XX		
C	06-OCT-2009	ECN-TW091001	Allen		SCALE: 1:1			
B	05-JUN-2008	ECN-CN080607	Yangxia	APPROVAL: Mike Wu	SHEET: 2/2			
A	29-MAR-2005	New Mold	Andy		PROJECTION:			
REV	DATE	FILE	BY					