



PCB terminal block; Push-button; 0.5 mm²; Pin spacing 2.54 mm; 5-pole; CAGE CLAMP®

Item No.: 234-505



PCB terminal block; Push-button; 0.5 mm²; Pin spacing 2.54 mm; 5-pole; CAGE CLAMP®

Marking

RoHS ✓
Compliant

Business data

Supplier	WAGO
Item no.	234-505
GTIN / EAN	4044918652131
Content	1
Order amount	85
Customer item number	

Notes

Item description: Terminal strips with push-buttons and CAGE CLAMP® connection Double solder pins for high mechanical stability on PCB Ideal for in-the-field wiring thanks to simplified push-button actuation Convenient, tool-free operation

Technical data

Miscellaneous

No. of poles	5
Pin spacing	2.54 mm (0.1 in)
Total number of connection points	5

Technical data	
Total number of potentials	5
Color	orange
Ratings per	IEC/EN 60664-1
Rated voltage (III / 3) [V]	63 [V]
Rated impulse voltage (III / 3) [kV]	2.5 [kV]
Rated voltage (III/2) [V]	160 [V]
Rated impulse voltage (III / 2) [kV]	2.5 [kV]
Rated voltage (II / 2) [V]	320 [V]
Rated impulse voltage (II / 2) [kV]	2.5 [kV]
Rated current [A]	6 [A]
Number of connection objects	1
Number of levels	1
Connection technology	CAGE CLAMP®
Number of connection points connector	1
Actuation type	Operating lever
Solid conductors, tool-operated termination	0.08 ... 0.5 mm ² / 28 ... 20 AWG
Fine-stranded conductors, tool-operated termination	0.08 ... 0.5 mm ² / 28 ... 20 AWG
Fine-stranded conductors with insulated ferrule	0.25 mm ² / AWG
Fine-stranded conductors with uninsulated ferrule	0.25 mm ² / AWG
Strip length	5 ... 6 mm / 0.2 ... 0.24 inch
Conductor entry angle to the PCB [°]	90 [°]
Cross section up to (1) [mm ²]	0.5 [mm ²]
Cross section from (1) [AWG]	28 [AWG]
Cross section from (2) [mm ²]	0.08 [mm ²]
Cross section up to (2) [mm ²]	0.5 [mm ²]
Solder pin arrangement	in line
Solder pin length [mm]	4 [mm]
Drilled hole diameter (tolerance) [mm]	1.1(+ 0.1) [mm]
Drilled hole diameter [mm] [mm]	1.1 [mm]
Tolerance of drilled hole diameter plus [mm] [mm]	+0.1 [mm]
Material group	I
Insulating material	Polyamide 66 (PA 66)
Flammability class per UL94	V0
Limit temperature range	-60 ... 105 C

Technical data	
<i>Clamping spring material</i>	<i>Chrome-nickel spring steel (CrNi)</i>
<i>Contact material</i>	<i>Electrolytic copper (Ecu)</i>
<i>Contact plating</i>	<i>tin-plated</i>
<i>Fire load [MJ]</i>	<i>0.039 [MJ]</i>
<i>Weight [g]</i>	<i>2.618 [g]</i>
<i>Width</i>	<i>14.9 mm / 0.587 in.</i>
<i>Height</i>	<i>18 mm / 0.709 in.</i>
<i>Height from the surface</i>	<i>14 mm / 0.551 in.</i>
<i>Depth</i>	<i>14.4 mm / 0.567 in.</i>

Images & drawings

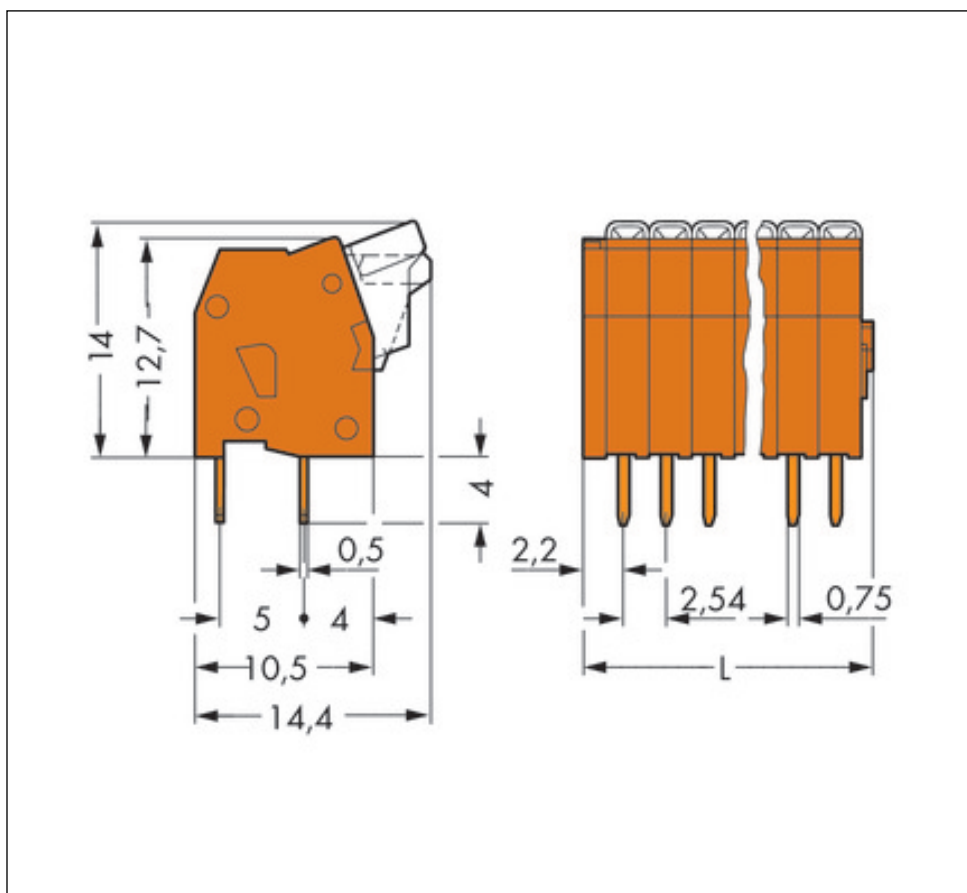
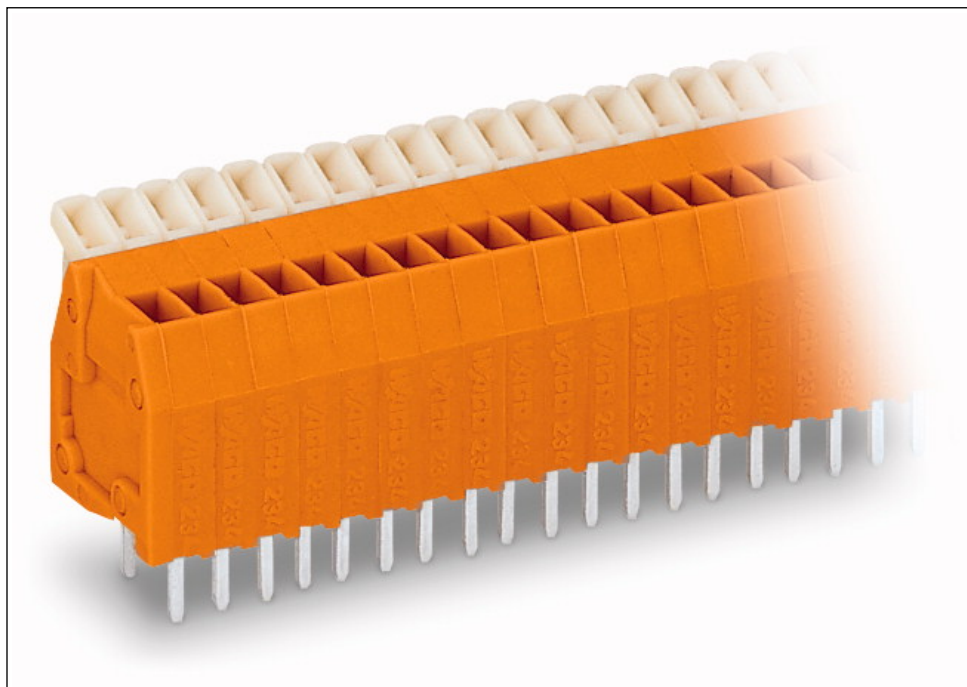

Address

WAGO Kontakttechnik GmbH & Co. KG

Hansastr. 27

32423 Minden

Telefon: 0571/887-0

Fax: 0571/887-169

<http://www.wago.com>

© WAGO Kontakttechnik GmbH & Co. KG

Technische Änderungen und Irrtümer vorbehalten.