

## Optocoupler, Phototransistor Output, With Base Connection

### Features

- Isolation Test Voltage 5300 V<sub>RMS</sub>
- Interfaces with common logic families
- Input-output coupling capacitance < 0.5 pF
- Industry Standard Dual-in line 6-pin package
- Lead-free component
- Component in accordance to RoHS 2002/95/EC and WEEE 2002/96/EC

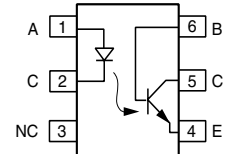
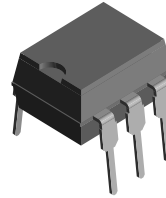

1179004



### Agency Approvals

- Underwriters Laboratory File #E52744
- DIN EN 60747-5-2 (VDE0884)  
DIN EN 60747-5-5 pending  
Available with Option 1

### Applications

AC mains detection  
Reed relay driving  
Switch mode power supply feedback  
Telephone ring detection  
Logic ground isolation  
Logic coupling with high frequency noise rejection

### Description

This data sheet presents five families of Vishay Industry Standard Single Channel Phototransistor Couplers. These families include the 4N35/ 4N36/ 4N37/ 4N38 couplers.

Each optocoupler consists of gallium arsenide infrared LED and a silicon NPN phototransistor.

These couplers are Underwriters Laboratories (UL) listed to comply with a 5300 V<sub>RMS</sub> isolation test voltage.

This isolation performance is accomplished through Vishay double molding isolation manufacturing process. Compliance to DIN EN 60747-5-2(VDE0884)/ DIN EN 60747-5-5 pending partial discharge isolation specification is available for these families by ordering option 1.

These isolation processes and the Vishay ISO9001 quality program results in the highest isolation performance available for a commercial plastic phototransistor optocoupler.

The devices are available in lead formed configuration suitable for surface mounting and are available either on tape and reel, or in standard tube shipping containers.

Note:

Designing with data sheet is cover in Application Note 45

### Order Information

Part	Remarks
4N35	CTR > 100 %, DIP-6
4N36	CTR > 100 %, DIP-6
4N37	CTR > 100 %, DIP-6
4N38	CTR > 20 %, DIP-6
4N35-X006	CTR > 100 %, DIP-6 400 mil (option 6)
4N35-X007	CTR > 100 %, SMD-6 (option 7)
4N35-X009	CTR > 100 %, SMD-6 (option 9)
4N36-X007	CTR > 100 %, SMD-6 (option 7)
4N36-X009	CTR > 100 %, SMD-6 (option 9)
4N37-X006	CTR > 100 %, DIP-6 400 mil (option 6)
4N37-X009	CTR > 100 %, SMD-6 (option 9)

For additional information on the available options refer to Option Information.

### Absolute Maximum Ratings

$T_{amb} = 25\text{ °C}$ , unless otherwise specified

Stresses in excess of the absolute Maximum Ratings can cause permanent damage to the device. Functional operation of the device is not implied at these or any other conditions in excess of those given in the operational sections of this document. Exposure to absolute Maximum Rating for extended periods of the time can adversely affect reliability.

### Input

Parameter	Test condition	Symbol	Value	Unit
Reverse voltage		$V_R$	6.0	V
Forward current		$I_F$	60	mA
Surge current	$\leq 10\ \mu\text{s}$	$I_{FSM}$	2.5	A
Power dissipation		$P_{diss}$	100	mW

### Output

Parameter	Test condition	Symbol	Value	Unit
Collector-emitter breakdown voltage		$V_{CEO}$	70	V
Emitter-base breakdown voltage		$V_{EBO}$	7.0	V
Collector current		$I_C$	50	mA
	$(t \leq 1.0\ \text{ms})$	$I_C$	100	mA
Power dissipation		$P_{diss}$	150	mW

### Coupler

Parameter	Test condition	Symbol	Value	Unit
Isolation test voltage		$V_{ISO}$	5300	$V_{RMS}$
Creepage			$\geq 7.0$	mm
Clearance			$\geq 7.0$	mm
Isolation thickness between emitter and detector			$\geq 0.4$	mm
Comparative tracking index per DIN IEC 112/VDE0303, part 1			175	
Isolation resistance	$V_{IO} = 500\ \text{V}, T_{amb} = 25\text{ °C}$	$R_{IO}$	$10^{12}$	$\Omega$
	$V_{IO} = 500\ \text{V}, T_{amb} = 100\text{ °C}$	$R_{IO}$	$10^{11}$	$\Omega$
Storage temperature		$T_{stg}$	- 55 to + 150	$^{\circ}\text{C}$
Operating temperature		$T_{amb}$	- 55 to + 100	$^{\circ}\text{C}$
Junction temperature		$T_j$	100	$^{\circ}\text{C}$
Soldering temperature	max. 10 s dip soldering: distance to seating plane $\geq 1.5\ \text{mm}$	$T_{sld}$	260	$^{\circ}\text{C}$



### Electrical Characteristics

T<sub>amb</sub> = 25 °C, unless otherwise specified

Minimum and maximum values are testing requirements. Typical values are characteristics of the device and are the result of engineering evaluation. Typical values are for information only and are not part of the testing requirements.

### Input

Parameter	Test condition	Symbol	Min	Typ.	Max	Unit
Forward voltage <sup>1)</sup>	I <sub>F</sub> = 10 mA	V <sub>F</sub>		1.3	1.5	V
	I <sub>F</sub> = 10 mA, T <sub>amb</sub> = - 55 °C	V <sub>F</sub>	0.9	1.3	1.7	V
Reverse current <sup>1)</sup>	V <sub>R</sub> = 6.0 V	I <sub>R</sub>		0.1	10	μA
Capacitance	V <sub>R</sub> = 0, f = 1.0 MHz	C <sub>O</sub>		25		pF

<sup>1)</sup> Indicates JEDEC registered value

### Output

Parameter	Test condition	Part	Symbol	Min	Typ.	Max	Unit
Collector-emitter breakdown voltage <sup>1)</sup>	I <sub>C</sub> = 1.0 mA	4N35	BV <sub>CEO</sub>	30			V
		4N36	BV <sub>CEO</sub>	30			V
		4N37	BV <sub>CEO</sub>	30			V
		4N38	BV <sub>CEO</sub>	80			V
Emitter-collector breakdown voltage <sup>1)</sup>	I <sub>E</sub> = 100 μA		BV <sub>ECO</sub>	7.0			V
Collector-base breakdown voltage <sup>1)</sup>	I <sub>C</sub> = 100 μA, I <sub>B</sub> = 1.0 μA	4N35	BV <sub>CBO</sub>	70			V
		4N36	BV <sub>CBO</sub>	70			V
		4N37	BV <sub>CBO</sub>	70			V
		4N38	BV <sub>CBO</sub>	80			V
Collector-emitter leakage current <sup>1)</sup>	V <sub>CE</sub> = 10 V, I <sub>F</sub> = 0	4N35	I <sub>CEO</sub>		5.0	50	nA
		4N36	I <sub>CEO</sub>		5.0	50	nA
	V <sub>CE</sub> = 10 V, I <sub>F</sub> = 0	4N37	I <sub>CEO</sub>		5.0	50	nA
	V <sub>CE</sub> = 30 V, I <sub>F</sub> = 0, T <sub>amb</sub> = 100 °C	4N38	I <sub>CEO</sub>			50	nA
		4N35	I <sub>CEO</sub>			500	μA
		4N36	I <sub>CEO</sub>			500	μA
	V <sub>CE</sub> = 30 V, I <sub>F</sub> = 0, T <sub>amb</sub> = 100 °C	4N37	I <sub>CEO</sub>			500	μA
V <sub>CE</sub> = 60 V, I <sub>F</sub> = 0, T <sub>amb</sub> = 100 °C	4N38	I <sub>CEO</sub>		6.0		μA	
Collector-emitter capacitance	V <sub>CE</sub> = 0		C <sub>CE</sub>		6.0		pF

<sup>1)</sup> Indicates JEDEC registered value

### Coupler

Parameter	Test condition	Symbol	Min	Typ.	Max	Unit
Resistance, input to output <sup>1)</sup>	V <sub>IO</sub> = 500 V	R <sub>IO</sub>	10 <sup>11</sup>			Ω
Capacitance (input-output)	f = 1.0 MHz	C <sub>IO</sub>		0.5		pF

<sup>1)</sup> Indicates JEDEC registered value

### Current Transfer Ratio

Parameter	Test condition	Part	Symbol	Min	Typ.	Max	Unit	
DC Current Transfer Ratio <sup>1)</sup>	$V_{CE} = 10\text{ V}$ , $I_F = 10\text{ mA}$	4N35	$CTR_{DC}$	100			%	
		4N36	$CTR_{DC}$	100			%	
		4N37	$CTR_{DC}$	100			%	
		$V_{CE} = 10\text{ V}$ , $I_F = 20\text{ mA}$	4N38	$CTR_{DC}$	20			%
	$V_{CE} = 10\text{ V}$ , $I_F = 10\text{ mA}$ , $T_A = -55\text{ to }+100\text{ }^\circ\text{C}$	4N35	$CTR_{DC}$	40	50		%	
		4N36	$CTR_{DC}$	40	50		%	
		4N37	$CTR_{DC}$	40	50		%	
		4N38	$CTR_{DC}$		30		%	

<sup>1)</sup> Indicates JEDEC registered value

### Switching Characteristics

Parameter	Test condition	Symbol	Min	Typ.	Max	Unit
Switching time <sup>1)</sup>	$I_C = 2\text{ mA}$ , $R_L = 100\ \Omega$ , $V_{CC} = 10\text{ V}$	$t_{on}$ , $t_{off}$		10		$\mu\text{s}$

<sup>1)</sup> Indicates JEDEC registered value

### Typical Characteristics ( $T_{amb} = 25\text{ }^\circ\text{C}$ unless otherwise specified)

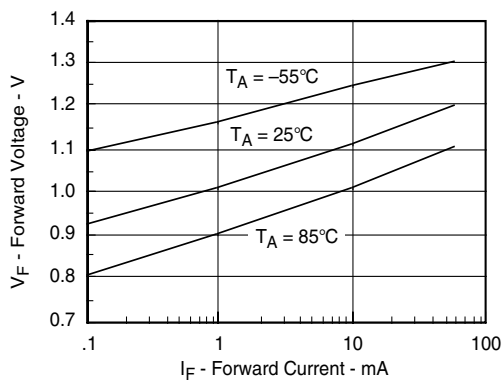

Figure 1. Forward Voltage vs. Forward Current

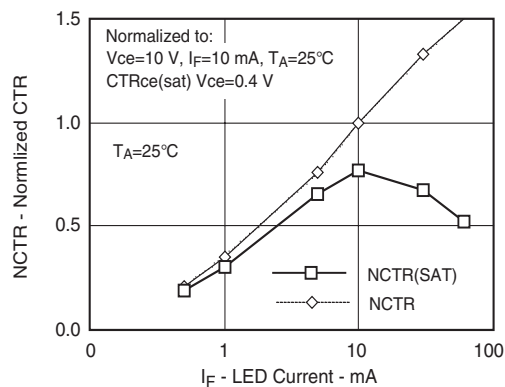
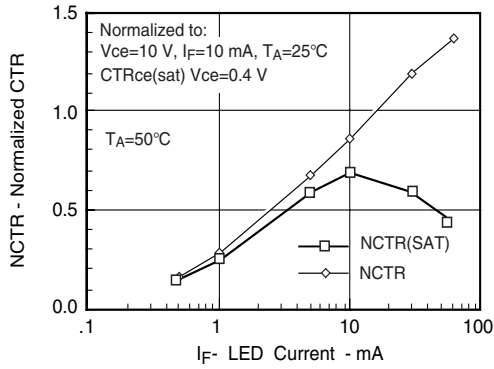
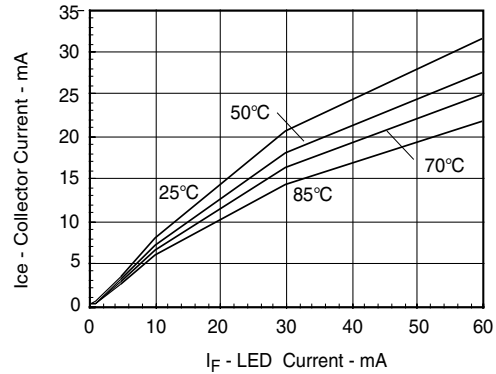

Figure 2. Normalized Non-Saturated and Saturated CTR vs. LED Current



4n25\_03

Figure 3. Normalized Non-saturated and Saturated CTR vs. LED Current



4n25\_06

Figure 6. Collector-Emitter Current vs. Temperature and LED Current

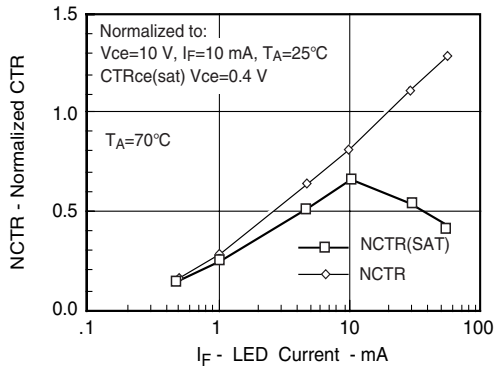

4n25\_04

Figure 4. Normalized Non-saturated and saturated CTR vs. LED Current

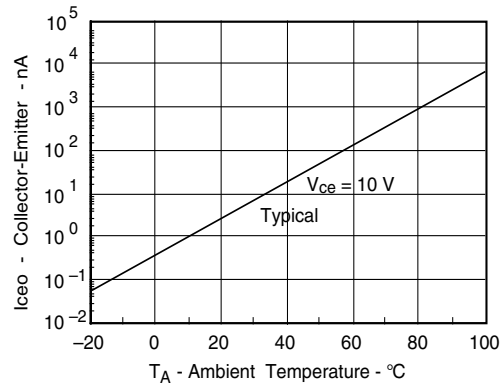

4n25\_07

Figure 7. Collector-Emitter Leakage Current vs.Temp.

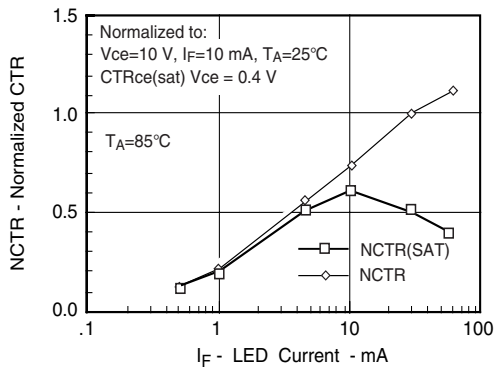

4n25\_05

Figure 5. Normalized Non-saturated and saturated CTR vs. LED Current

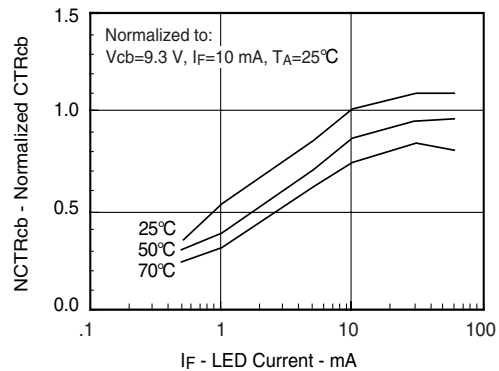

4n25\_08

Figure 8. Normalized CTRcb vs. LED Current and Temp.

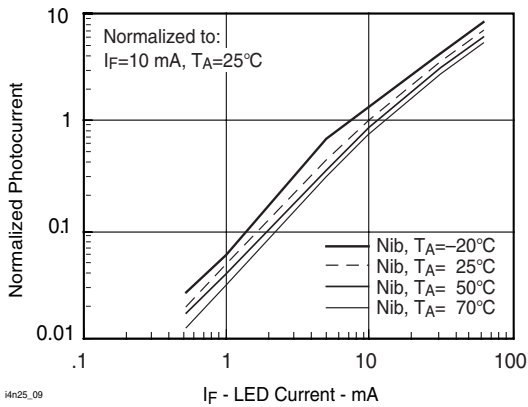

Figure 9. Normalized Photocurrent vs.  $I_F$  and Temp.

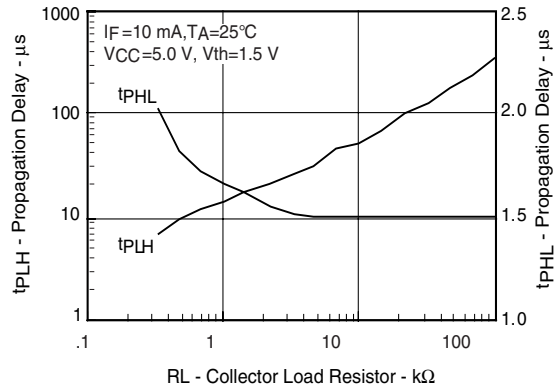

Figure 12. Propagation Delay vs. Collector Load Resistor

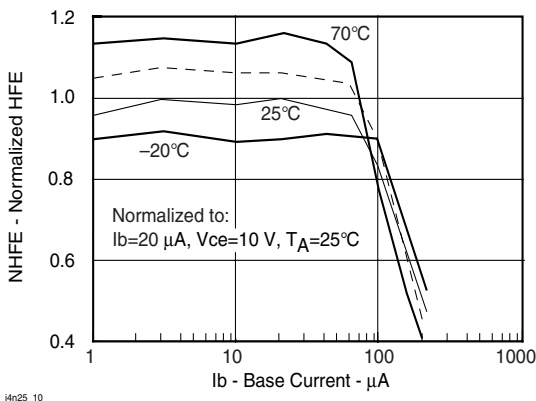

Figure 10. Normalized Non-saturated HFE vs. Base Current and Temperature

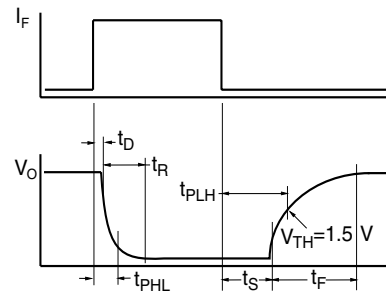

Figure 13. Switching Timing

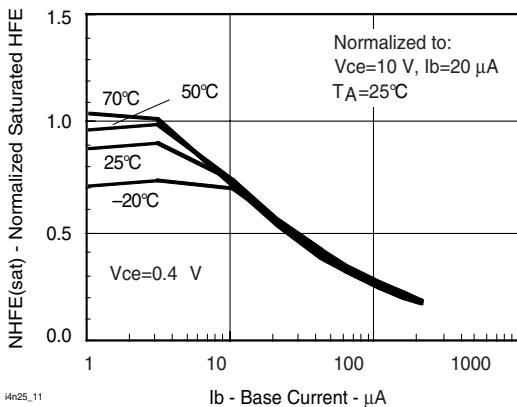

Figure 11. Normalized HFE vs. Base Current and Temp.

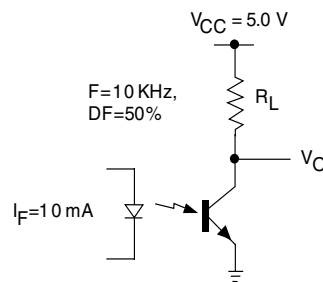

Figure 14. Switching Schematic

## Package Dimensions in Inches (mm)

For 4N35/36/37/38..... see DIL300-6 Package dimension in the Package Section.

For products with an option designator (e.g. 4N35-X006 or 4N36-X007)..... see DIP-6 Package dimensions in the Package Section.

### DIL300-6 Package Dimensions

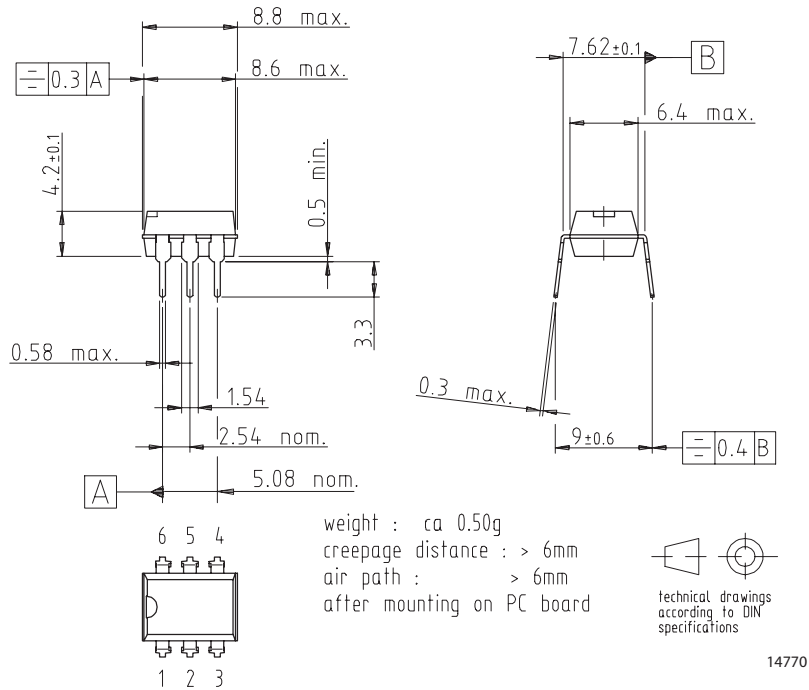

### DIP-6 Package Dimensions

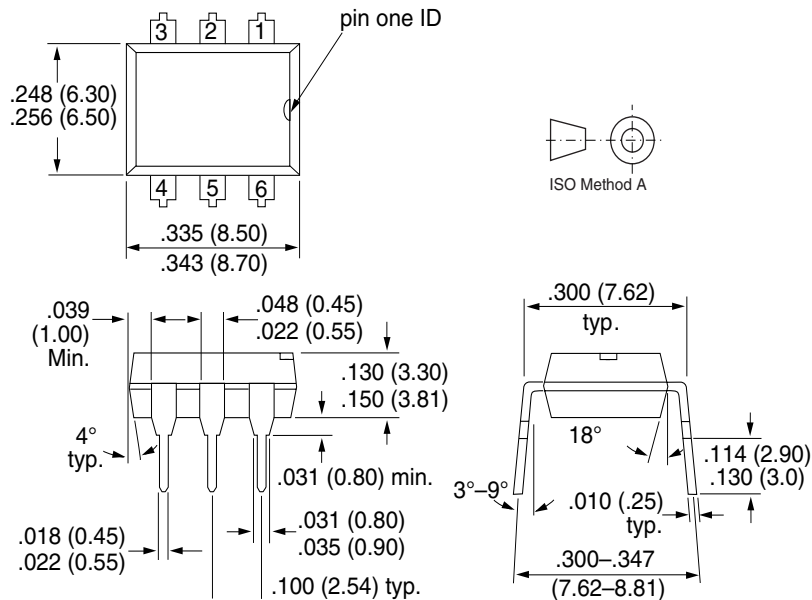

# 4N35/ 4N36/ 4N37/ 4N38

Vishay Semiconductors



Option 6

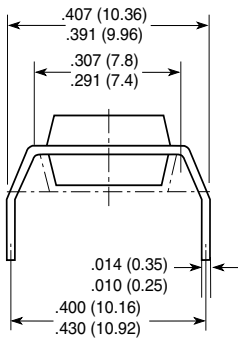

Option 7

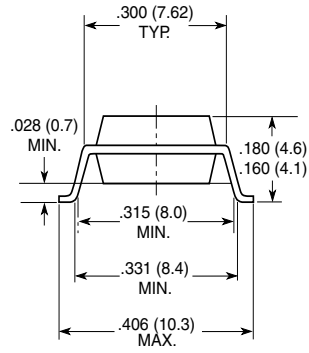

Option 9

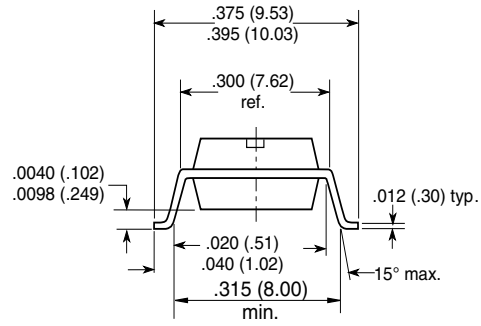

18450





## Ozone Depleting Substances Policy Statement

It is the policy of Vishay Semiconductor GmbH to

1. Meet all present and future national and international statutory requirements.
2. Regularly and continuously improve the performance of our products, processes, distribution and operating systems with respect to their impact on the health and safety of our employees and the public, as well as their impact on the environment.

It is particular concern to control or eliminate releases of those substances into the atmosphere which are known as ozone depleting substances (ODSs).

The Montreal Protocol (1987) and its London Amendments (1990) intend to severely restrict the use of ODSs and forbid their use within the next ten years. Various national and international initiatives are pressing for an earlier ban on these substances.

Vishay Semiconductor GmbH has been able to use its policy of continuous improvements to eliminate the use of ODSs listed in the following documents.

1. Annex A, B and list of transitional substances of the Montreal Protocol and the London Amendments respectively
2. Class I and II ozone depleting substances in the Clean Air Act Amendments of 1990 by the Environmental Protection Agency (EPA) in the USA
3. Council Decision 88/540/EEC and 91/690/EEC Annex A, B and C (transitional substances) respectively.

Vishay Semiconductor GmbH can certify that our semiconductors are not manufactured with ozone depleting substances and do not contain such substances.

We reserve the right to make changes to improve technical design and may do so without further notice.

Parameters can vary in different applications. All operating parameters must be validated for each customer application by the customer. Should the buyer use Vishay Semiconductors products for any unintended or unauthorized application, the buyer shall indemnify Vishay Semiconductors against all claims, costs, damages, and expenses, arising out of, directly or indirectly, any claim of personal damage, injury or death associated with such unintended or unauthorized use.

Vishay Semiconductor GmbH, P.O.B. 3535, D-74025 Heilbronn, Germany  
Telephone: 49 (0)7131 67 2831, Fax number: 49 (0)7131 67 2423



### Notice

Specifications of the products displayed herein are subject to change without notice. Vishay Intertechnology, Inc., or anyone on its behalf, assumes no responsibility or liability for any errors or inaccuracies.

Information contained herein is intended to provide a product description only. No license, express or implied, by estoppel or otherwise, to any intellectual property rights is granted by this document. Except as provided in Vishay's terms and conditions of sale for such products, Vishay assumes no liability whatsoever, and disclaims any express or implied warranty, relating to sale and/or use of Vishay products including liability or warranties relating to fitness for a particular purpose, merchantability, or infringement of any patent, copyright, or other intellectual property right.

The products shown herein are not designed for use in medical, life-saving, or life-sustaining applications. Customers using or selling these products for use in such applications do so at their own risk and agree to fully indemnify Vishay for any damages resulting from such improper use or sale.