



PCB terminal block; 2.5 mm²; Pin spacing 5/5.08 mm; 5-pole; PUSH WIRE®

Item No.: 235-405



PCB terminal block; 2.5 mm²; Pin spacing 5/5.08 mm; 5-pole; PUSH WIRE®

Marking

RoHS ✓
Compliant

Business data

Supplier	WAGO
Item no.	235-405
GTIN / EAN	4044918654586
Content	1
Order amount	45
Customer item number	

Notes

Item description: Low-profile terminal strips with screwdriver-actuated PUSH WIRE® termination Simple push-in termination for solid conductors Double solder pins for high mechanical stability Conductor removal via screwdriver (2.5mm x 0.4mm) Set to metric or inch pin spacing by compressing terminal strips together or pulling them apart Also available with test slot

Technical data

Miscellaneous

No. of poles	5
Pin spacing	5/5.08 mm / 0.197/0.2 in
Total number of connection points	5

Technical data	
Total number of potentials	5
Color	gray
Ratings per	IEC/EN 60664-1
Rated voltage (III / 3) [V]	250 [V]
Rated impulse voltage (III / 3) [kV]	4 [kV]
Rated voltage (III/2) [V]	320 [V]
Rated impulse voltage (III / 2) [kV]	4 [kV]
Rated voltage (II / 2) [V]	630 [V]
Rated impulse voltage (II / 2) [kV]	4 [kV]
Rated current [A]	24 [A]
Number of connection objects	1
Number of levels	1
Connection technology	PUSH WIRE®
Number of connection points connector	1
Actuation type	Operating tool
Solid conductors, tool-operated termination	0.5 ... 2.5 mm ² / 20 ... 14 AWG
Fine-stranded conductors with insulated ferrule	0.25 ... 1.5 mm ² / ...
Fine-stranded conductors with uninsulated ferrule	0.25 ... 1.5 mm ² / ...
Strip length	9 ... 10 mm / 0.35 ... 0.39 inch
Conductor entry angle to the PCB [°]	0 [°]
Cross section up to (1) [mm ²]	2.5 [mm ²]
Cross section from (1) [AWG]	20 [AWG]
Cross section from (2) [mm ²]	0.25 [mm ²]
Cross section up to (2) [mm ²]	1.5 [mm ²]
Solder pin arrangement	in line
Solder pin length [mm]	3.6 [mm]
Drilled hole diameter (tolerance) [mm]	1(+ 0.1) [mm]
Drilled hole diameter [mm] [mm]	1 [mm]
Tolerance of drilled hole diameter plus [mm] [mm]	+0.1 [mm]
Material group	I
Insulating material	Polyamide 66 (PA 66)
Flammability class per UL94	V0
Limit temperature range	-60 ... 105 C
Clamping spring material	Chrome-nickel spring steel (CrNi)
Contact material	Electrolytic copper (Ecu)

Technical data	
<i>Contact plating</i>	<i>tin-plated</i>
<i>Fire load [MJ]</i>	<i>0.059 [MJ]</i>
<i>Weight [g]</i>	<i>3.487 [g]</i>
<i>Width</i>	<i>26.5 mm / 1.043 in.</i>
<i>Height</i>	<i>12.8 mm / 0.504 in.</i>
<i>Height from the surface</i>	<i>9.2 mm / 0.362 in.</i>
<i>Depth</i>	<i>12.5 mm / 0.492 in.</i>
<i>Pin spacing up to [in]</i>	<i>0.2 [in]</i>

Images & drawings

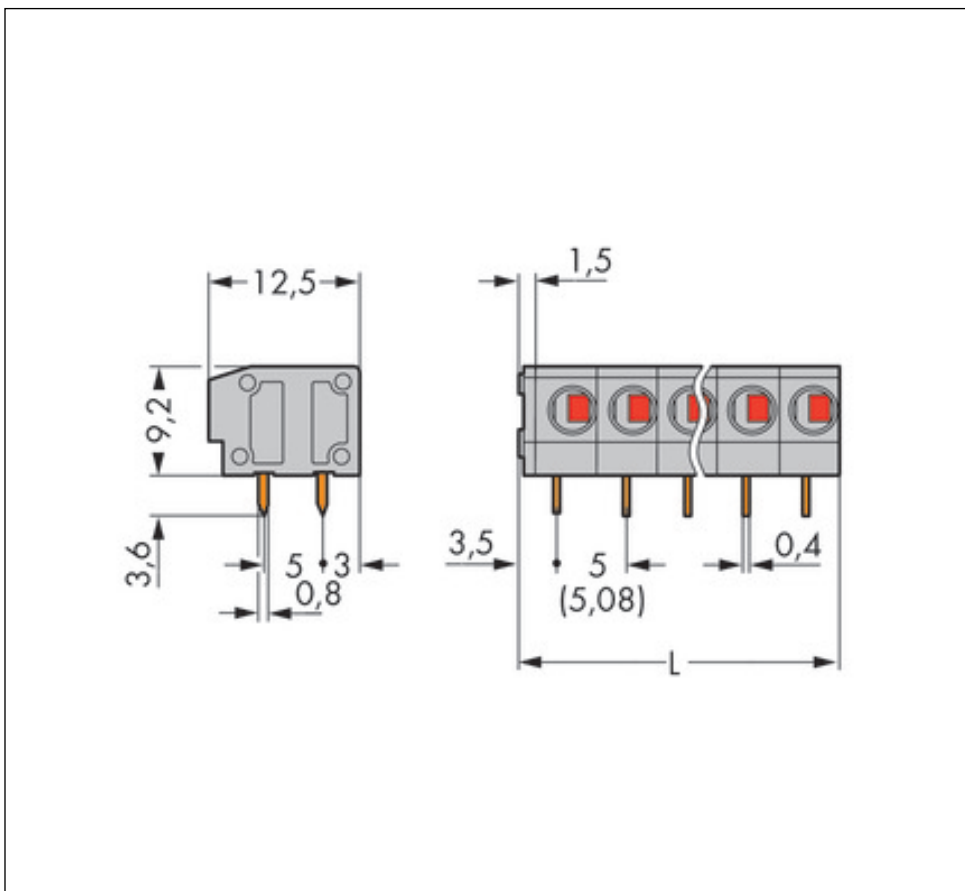
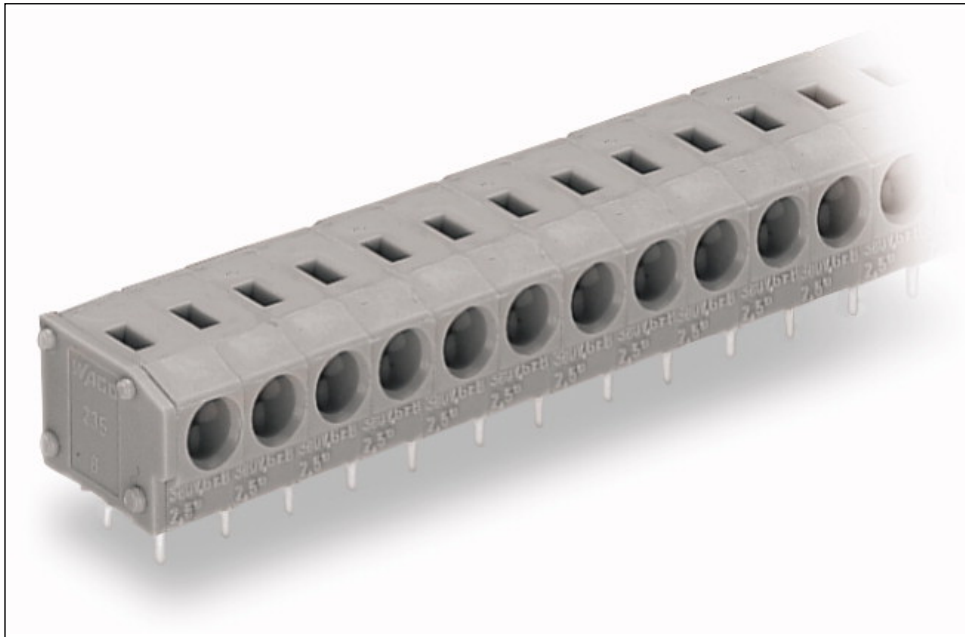

Address

WAGO Kontakttechnik GmbH & Co. KG

Hansastr. 27

32423 Minden

Telefon: 0571/887-0

Fax: 0571/887-169

<http://www.wago.com>

© WAGO Kontakttechnik GmbH & Co. KG

Technische Änderungen und Irrtümer vorbehalten.