

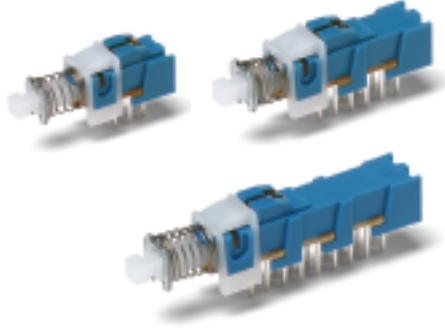

PHA Series Short Stroke Pushbutton Switches



Features/Benefits

- **Momentary or latching action**
- **Low cost, reliable contact design**
- **2, 4 & 6 pole configurations**
- **Sealed contacts**
- **Optional buttons**
- **RoHS compliant**

Typical Applications

- **Computers and peripherals**
- **Instrumentation and measurement equipment**
- **Non-power, on-off switch applications**

Specifications

SWITCHING POWER MAX.: 3 W DC
 SWITCHING VOLTAGE MAX.: 30 V DC
 SWITCHING CURRENT MAX.: 100 mA DC
 DIELECTRIC STRENGTH (50 Hz/1 min.): 500 V between open contacts. 1500 V between chassis and contacts.
 OPERATING LIFE: Impulse/momentary (OA): $\wedge 10^4$ operations.
 Latching (EE): $\wedge 10^4$ operations
 CONTACT RESISTANCE: New: $\%20\ m\Omega$
 After 105 operations: $\%40\ m\Omega$
 INSULATION RESISTANCE: $\wedge 10^{10}\ \Omega$
 CAPACITANCE: $\%1.5\ pF$
 CONTACT BOUNCE: $\%2\ ms$
 Operating speed 200 mm/s (7.87 inch/s)
 TOTAL TRAVEL/LATCHING TRAVEL: 2.5mm/1.5mm
 (.0984 inch/.0591 inch)
 OPERATING FORCE:
 2U: 170cN \pm 50cN (170 grams \pm 50 grams)
 4U: 230cN \pm 70cN (230 grams \pm 70 grams)
 6U: 300cN \pm 100cN (300 grams \pm 100 grams)
 SEALING: Sealed contacts.

Materials

FIXED TERMINAL: Brass, silver plated.
 MOVABLE CONTACT: Phosphor bronze, silver plated.
 SWITCH BODY: PPE
 ACTUATOR: POM
 STANDOFF CLIP: POM
 RETURN SPRING: Music wire.
 RETURN SPRING RETAINER: Carbon steel, tin plated.
 DETENT SPRING PLATE: Phosphor bronze.
 DETENT SPRING: Stainless steel.
 BASE: Laminated phenolic.
 TERMINAL SEAL: Epoxy.

NOTE: All models are RoHS compliant and compatible.

NOTE: Specifications and materials listed above are for switches with standard options. For information on specific and custom switches, consult Customer Service Center.

Build-A-Switch

To order, simply select desired option from each category and place in the appropriate box. Available options are shown and described on pages A-85 thru A-87. For additional options not shown in catalog, consult Customer Service Center.

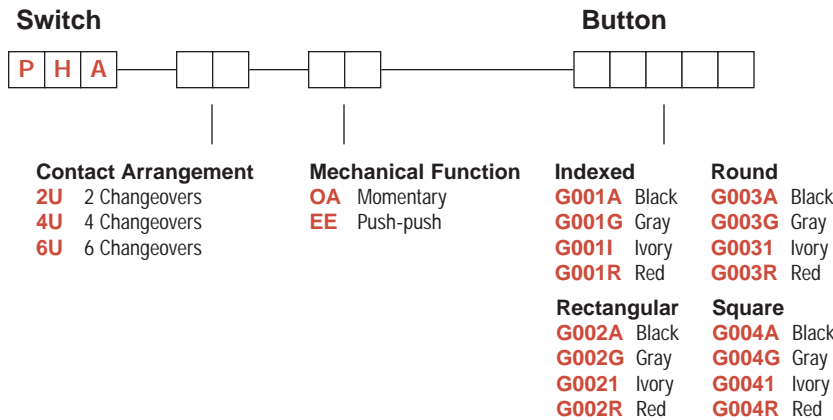

BUTTON REMOVAL

A button of a push-push switch should only be removed in the "OFF" non-latching position.

PHA Series Short Stroke Pushbutton Switches



A

Pushbutton

DESIGNATION

2U 2 CHANGEOVERS

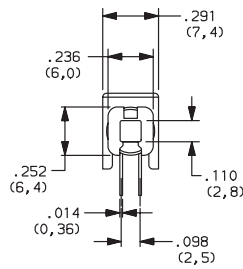
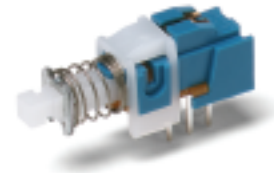
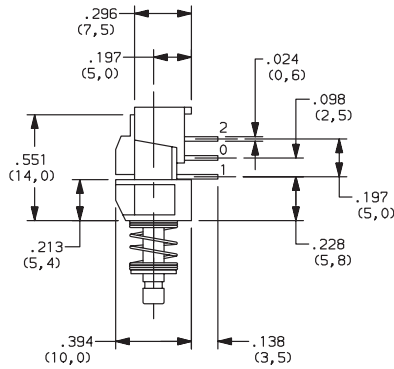
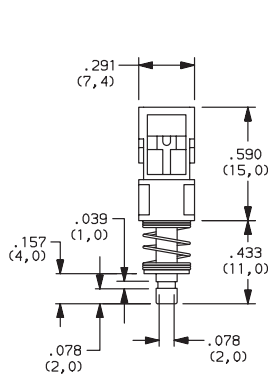

PC MOUNTING

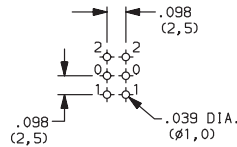

4U 4 CHANGEOVERS

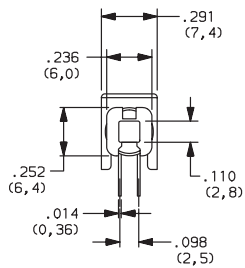
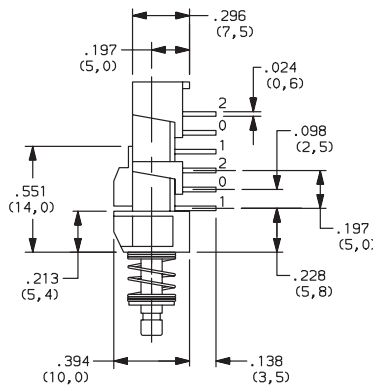
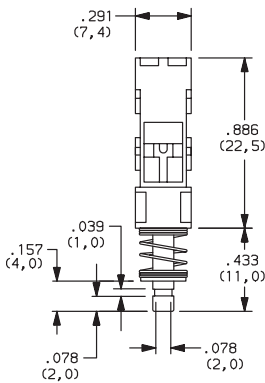

PC MOUNTING

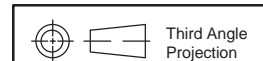
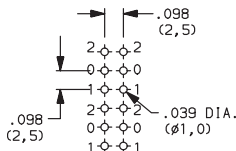

Dimensions are shown: Inches (mm)
Specifications and dimensions subject to change



PHA Series Short Stroke Pushbutton Switches

DESIGNATION

Pushbutton

A

6U 6 CHANGEOVERS

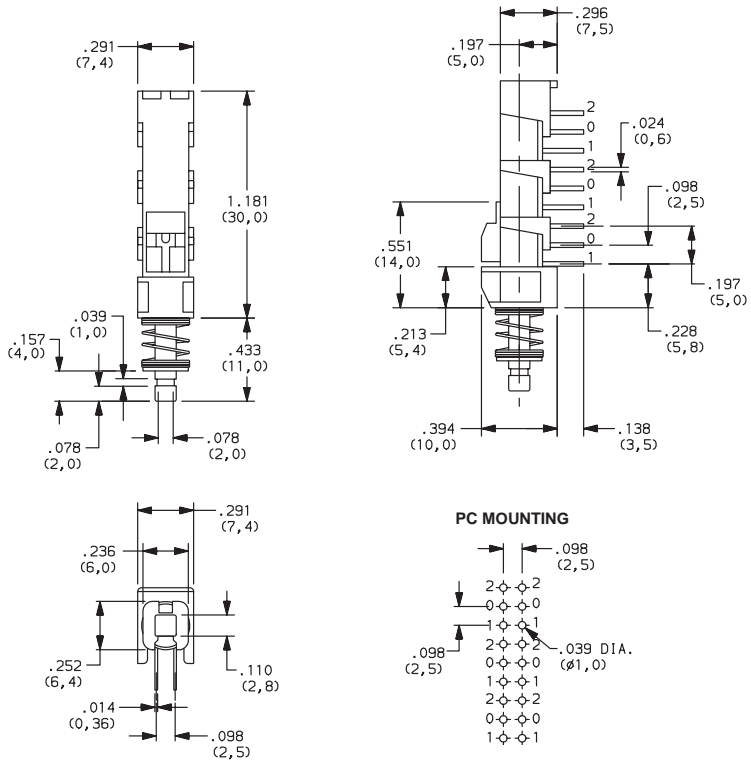
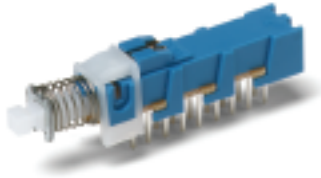

CONTACT ARRANGEMENT

OPTION CODE	NO. OF POLES *	SCHEMATIC
2U	2PDT	
4U	4PDT	2X
6U	6PDT	3X

*Non-shorting contacts.

MECHANICAL FUNCTION

OPTION CODE	FUNCTION
OA	Momentary
EE	Push-push

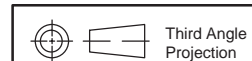

Dimensions are shown: Inches (mm)
Specifications and dimensions subject to change

PHA Series Short Stroke Pushbutton Switches



A

Pushbutton

BUTTONS

Indexed

- G001A** Black
- G001G** Gray
- G001I** Ivory
- G001R** Red

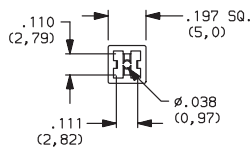
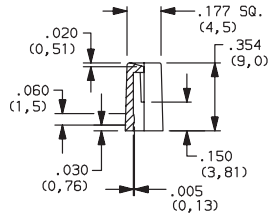

Rectangular

- G002A** Black
- G002G** Gray
- G002I** Ivory
- G002R** Red

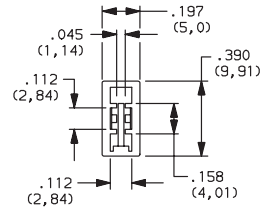
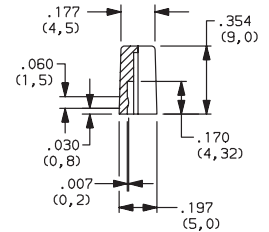

Round

- G003A** Black
- G003G** Gray
- G003I** Ivory
- G003R** Red

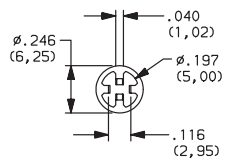
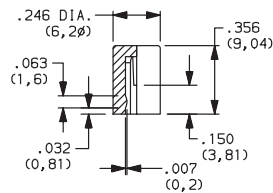

Square

- G004A** Black
- G004G** Gray
- G004I** Ivory
- G004R** Red

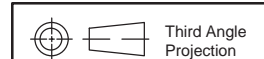
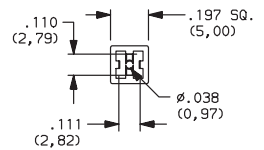
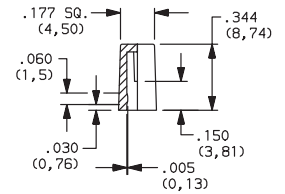
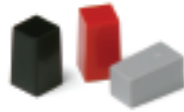

Dimensions are shown: Inches (mm)
Specifications and dimensions subject to change