

TSR-3296 & 3266



玻璃釉微調電位器

- 多圈的/金屬陶瓷/工業用/密封
(Multiturn/ Cermet/ Industrial/ Sealed)
- 5種引線的安裝尺寸
(5 Terminal Styles)

電氣特性	Electrical Characteristics	
	TSR-3296	TSR-3266
標稱阻值範圍 Standard Resistance Range	10Ω - 5MΩ	10Ω - 5MΩ
阻值允許偏差 Resistance Tolerance	±10% (±20% only for 10 ohm)	±10%
終端電阻 Absolute Minimum Resistance	≤1% R 或 10n	≤1% R 或 10Ω
接觸電阻變化 Contact Resistance Variation	CRV≤3%或 5n	CRV≤3%或 5Ω
絕緣電阻 Insulation Resistance	R1≥1GΩ(100Vac)	R1≥1GΩ(100Vac)
耐電壓 Withstand Voltage	640Vac	500Vac
有效行程 Effective Travel	30±2 turns nom	12±2 turns nom

環境特性	Environmental Characteristics	
	TSR-3296	TSR-3266
額定功率 Power Rating (315Volts max)	0.5W@70°C, 0W@125°C	0.25W@70°C, 0W@125°C
溫度範圍 Temperature Range	-55°C ~ +125°C	-55°C ~ +125°C
溫度係數 Temperature Coefficient	General offer ±250 ppm/°C (±100ppm/°C is available if request.)	General offer ±250 ppm/°C (±100ppm/°C is available if request.)
溫度變化 Temperature Variation	-55°C, 30min, +125°C 30min, 循環5次 5 cycles ΔR≤5%R, Δ(Uab/Uac)≤5%	-55°C, 30min, +125°C 30min, 循環5次 5 cycles ΔR≤5%R, Δ(Uab/Uac)≤5%
振動 Vibration	10 - 500Hz, 0.75mm, 6h ΔR≤5%R, Δ(Uab/Uac)≤7.5%	10 - 500Hz, 0.75mm, 6h ΔR≤5%R, Δ(Uab/Uac)≤7.5%
碰撞 Collision	390m/s ² , 4000cycles, ΔR≤5%R	390m/s ² , 4000cycles, ΔR≤5%R
70°C 耐久性 Electrical Endurance at 70°C	0.5W@70°C 1000h, ΔR≤10%R CRV≤3% or 5Ω	0.25W@70°C 1000h, ΔR≤10%R CRV≤3% or 5Ω
機械壽命 Rotational Life	200 周 (200 cycles) ΔTR≤10%R, CRV≤3% or 5n	200 周 (200 cycles) ΔR≤10%R, CRV≤3% or 5Ω

TSR-3296

共有尺寸 Common Dimensions

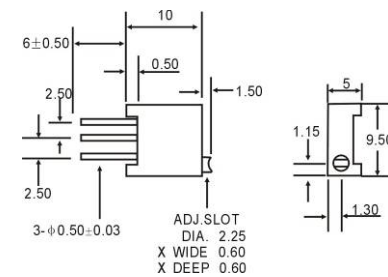

TSR-3296P

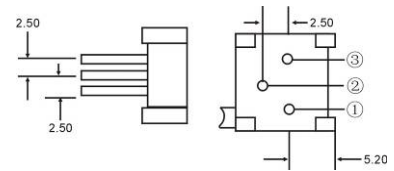

TSR-3296X

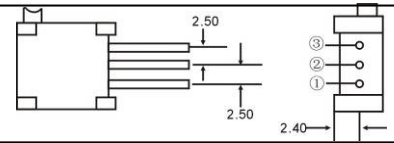

TSR-3296Z

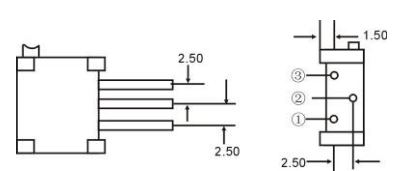

TSR-3296W

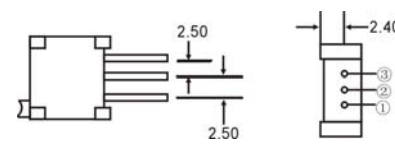

TSR-3296Y

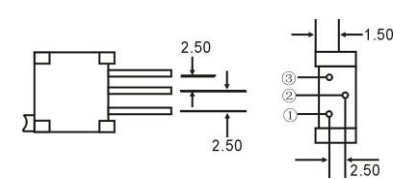

TSR-3266

共有尺寸 Common Dimensions

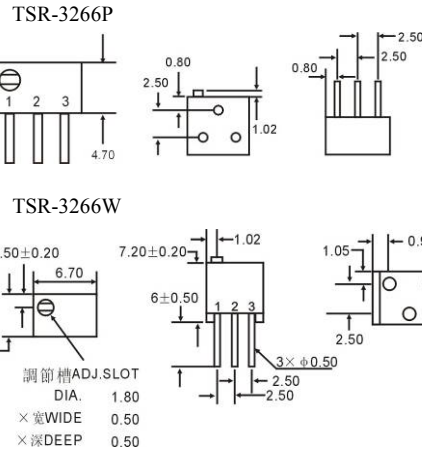

TSR-3266X

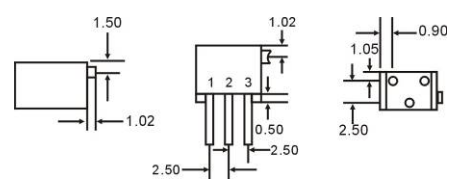

TSR-3266Z

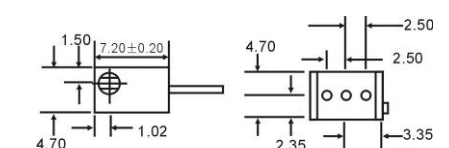

TSR-3266Y

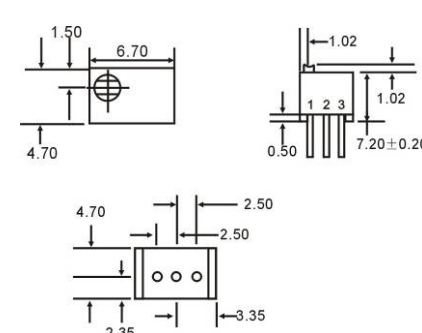

阻值代碼表 Standard Resistance table

Resistance(Ohms)	Resistance Code
10	100
20	200
50	500
100	101
150	151
200	201
250	251
300	301
470	471
500	501
680	681
1,000	102
1,500	152
2,000	202
2,200	222
2,500	252
3,000	302
4,700	472
5,000	502
6,800	682
10,000	103
15,000	153
20,000	203
22,000	223
25,000	253
30,000	303
33,000	333
47,000	473
50,000	503
68,000	683
100,000	104
150,000	154
200,000	204
220,000	224
250,000	254
300,000	304
330,000	334
470,000	474
500,000	504
680,000	684
1,000,000	105
2,000,000	205
2,200,000	225
5,000,000	505

訂購指南 How to Order

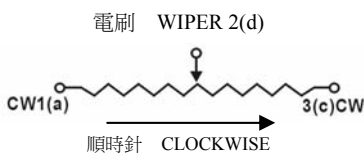
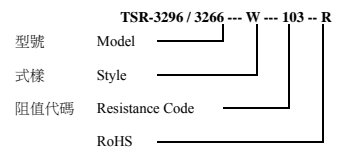

圖中公差：除注明外均為±0.25
Tolerance is ±0.25 if no identification

物理特性	Physical Characteristics
起動力矩 Starting Torque	≤35mN·m
標誌 Marking	阻值允許偏差(±10%不標注) 阻值代碼產品型號 Resistance Tolerance Resistance Code, Model (When no identification, it is of ±10%)
標準包裝 Standard Packaging	50 只/管 (50pcs, per tube)

可按用戶要求提供特殊規格
Special resistances available.

Note: Specification are subject to change without notice. For more detail and update, please visit our website.