

Total solder points: 170

Difficulty level:

beginner 1  2  3  4  5  advanced

velleman-kit  HIGH-Q

# CODELOCK RECEIVER

## K6707

### Features:

- Easy to build: no coils to be made!
- Operates in conjunction with the K6706 two channel transmitter.
- 8.748 possible codes.
- Range of the transmitter/receiver: +/-30m.
- LED on/off indication.
- LED receiving level indicator.

### Specifications :

- Relay output: 10A toggle or momentary contact.
- Separate output to switch car alarm on or off.
- Power supply: 2 x 9VAC or 12 to 16VDC / 100mA max.
- Dimensions: 76 x 84mm / 3 x 3,4"

\* modifications reserved.

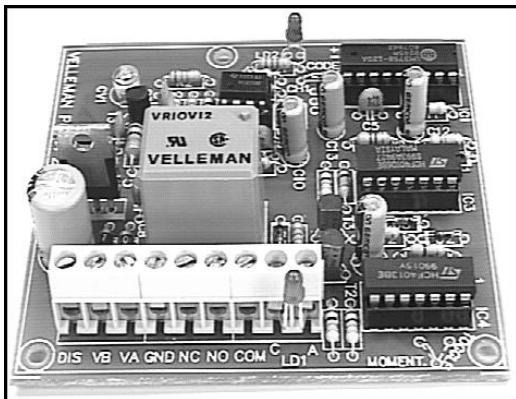



**VELLEMAN Components NV**  
**Legen Heirweg 33**  
**9890 Gavere**  
**Belgium Europe**  
**[www.velleman.be](http://www.velleman.be)**  
**[www.velleman-kit.com](http://www.velleman-kit.com)**

### 1. Assembly (Skipping this can lead to troubles !)

Ok, so we have your attention. These hints will help you to make this project successful. Read them carefully.

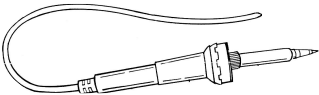
#### 1.1 Make sure you have the right tools:

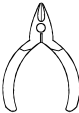
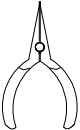
- A good quality soldering iron (25-40W) with a small tip. 
- Wipe it often on a wet sponge or cloth, to keep it clean; then apply solder to the tip, to give it a wet look. This is called 'thinning' and will protect the tip, and enables you to make good connections. When solder rolls off the tip, it needs cleaning.
- Thin rosin-core solder. Do not use any flux or grease. 
- A diagonal cutter to trim excess wires. To avoid injury when cutting excess leads, hold the lead so they cannot fly towards the eyes. 
- Needle nose pliers, for bending leads, or to hold components in place. 
- Small blade and Phillips screwdrivers. A basic range is fine.



**For some projects, a basic multi-meter is required, or might be handy**

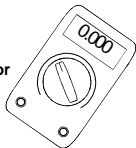

#### 1.2 Assembly Hints :

- ⇒ Make sure the skill level matches your experience, to avoid disappointments.
- ⇒ Follow the instructions carefully. Read and understand the entire step before you perform each operation.
- ⇒ Perform the assembly in the correct order as stated in this manual
- ⇒ Position all parts on the PCB (Printed Circuit Board) as shown on the drawings.
- ⇒ Values on the circuit diagram are subject to changes.
- ⇒ Values in this assembly guide are correct\*
- ⇒ Use the check-boxes to mark your progress.
- ⇒ Please read the included information on safety and customer service

\* Typographical inaccuracies excluded. Always look for possible last minute manual updates, indicated as 'NOTE' on a separate leaflet.

### 1.3 Soldering Hints :

Mount the component against the PCB surface and carefully solder the leads

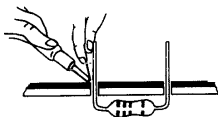

Make sure the solder joints are cone-shaped and shiny



Trim excess leads as close as possible to the solder joint

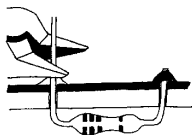

**AXIAL COMPONENTS ARE TAPED IN THE CORRECT MOUNTING SEQUENCE !**

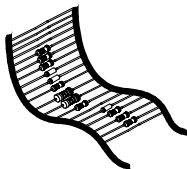

**REMOVE THEM FROM THE TAPE ONE AT A TIME !**

Velleman hereby certifies that the device K6707 meets the essential requirements and all other relevant stipulations of directive 1999/5/EG and 1995/5/EC.

For the complete conformity declaration check out :  
[http://www.velleman.be/downloads/doC/CE\\_K6707.pdf](http://www.velleman.be/downloads/doC/CE_K6707.pdf)

5%

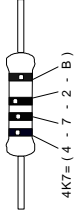

4K7 = ( 4 - 7 - 2 - B )

1%

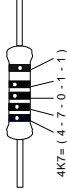

4K7 = ( 4 - 7 - 0 - 1 - 1 )

COLOR= 2...5



	I	P	E	SF	S	DK	N	D	GB	F	NL
C O D E	CODICE COLORE	CODIGO DE CORES	CODIGO DE COL- ORES	VÄRI/ KOODI	FÄRG SCHEMA	FARVE- KODE	FARGE- KODE	FARB KODE	COLOUR CODE	CODIFI- CATION DES COU- LEURS	KLEUR KODE
0	Nero	Preto	Negro	Musta	Svart	Sort	Sort	Schwarz	Black	Noir	Zwart
1	Marrone	Castanho	Marrón	Ruskea	Brun	Brun	Brun	Braun	Brown	Brun	Bruin
2	Rosso	Encarnado Rojo		Punainen	Röd	Röd	Röd	Rot	Red	Rouge	Rood
3	Aranciato	Laranja	Naranjado	Oranssi	Orange	Orange	Orange	Orange	Orange	Orange	Oranje
4	Giallo	Amarelo	Amarillo	Keltainen	Gul	Gul	Gul	Gelb	Yellow	Jaune	Geel
5	Verde	Verde	Verde	Vihreä	Grön	Grön	Grønn	Grün	Green	Vert	Groen
6	Blu	Azul	Azul	Sininen	Blå	Blå	Blå	Blau	Blue	Bleu	Blauw
7	Viola	Violeta	Morado	Purppura	Lila	Violet	Violet	Violet	Purple	Violet	Paars
8	Grigio	Cinzeno	Gris	Harmaa	Grå	Grå	Grå	Grau	Grey	Gris	Grijs
9	Bianco	Branco	Bianco	Valkoinen	Vit	Hvid	Hvidt	Weiss	White	Blanc	Wit
A	Argento	Prateado	Plata	Hopea	Silver	Sølv	Sølv	Silber	Silver	Argent	Zilver
B	Oro	Dourado	Oro	Kulta	Guld	Guld	Guldl	Gold	Gold	Or	Goud

**NOTE :**

**By using the jumpers, the receiver can be set up for two output possibilities:**

1. **The output is on** while the transmitter is pressed (MOMENT), this is mostly used for operating a door lock, garage door etc.
2. **The output switches (on/off)** every time the transmitter is pressed (toggle), this setting is mostly used for switching alarms in and out, for operating central door locking systems, for switching a lamp on and off, etc. This setting must be used for use with our car alarm K3504.

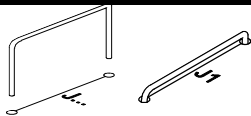
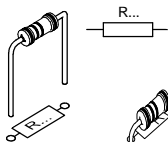
**1. Jumper wires**
 J
**2. 1/4W Resistors**

- |                                   |           |
|-----------------------------------|-----------|
| <input type="checkbox"/> R1 : 270 | (2-7-1-B) |
| <input type="checkbox"/> R2 : 18K | (1-8-3-B) |
| <input type="checkbox"/> R3 : 18K | (1-8-3-B) |

- |                                     |           |
|-------------------------------------|-----------|
| <input type="checkbox"/> R4 : 33K   | (3-3-3-B) |
| <input type="checkbox"/> R5 : 5K6   | (5-6-2-B) |
| <input type="checkbox"/> R6 : 2K7   | (2-7-2-B) |
| <input type="checkbox"/> R7 : 6K8   | (6-8-2-B) |
| <input type="checkbox"/> R8 : 6M8   | (6-8-5-B) |
| <input type="checkbox"/> R9 : 1K    | (1-0-2-B) |
| <input type="checkbox"/> R10 : 1K   | (1-0-2-B) |
| <input type="checkbox"/> R11 : 100K | (1-0-4-B) |
| <input type="checkbox"/> R12 : 47K  | (4-7-3-B) |
| <input type="checkbox"/> R13 : 47K  | (4-7-3-B) |
| <input type="checkbox"/> R14 : 470  | (4-7-1-B) |
| <input type="checkbox"/> R15 : 470K | (4-7-4-B) |
| <input type="checkbox"/> R16 : 10K  | (1-0-3-B) |
| <input type="checkbox"/> R17 : 10K  | (1-0-3-B) |
| <input type="checkbox"/> R18 : 10K  | (1-0-3-B) |
| <input type="checkbox"/> R19 : 220K | (2-2-4-B) |
| <input type="checkbox"/> R20 : 680  | (6-8-1-B) |
| <input type="checkbox"/> R21 : 2K2  | (2-2-2-B) |

### 3. Diodes

Watch the polarity !

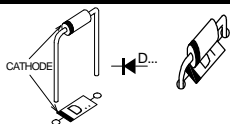

- D1 : 1N4148
- D2 : 1N4148
- D3 : 1N4148
- D4 : 1N4148
- D5 : 1N4148
- D6 : 1N4000 ... 4007
- D7 : 1N4000 ... 4007

### 4. Zener diodes

Watch the polarity !

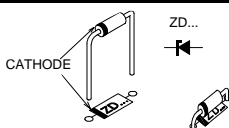

- ZD1 : 4V3
- ZD2 : 4V7 (5V1)

### 5. SAW resonator

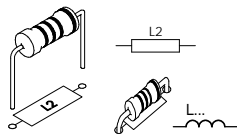

- L1 : 1 $\mu$ H (1-0-B)

### 6. Capacitors

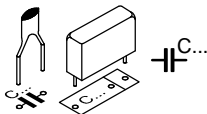

- C1 : 2pF (2p2)
- C2 : 2pF (2p2)
- C3 : 22pF
- C4 : 82pF
- C5 : 330pF (331)
- C6 : 330pF (331)
- C7 : 330pF (331)
- C8 : 100nF (104,  $\mu$ 1)
- C9 : 100nF (104,  $\mu$ 1)

### 7. IC sockets.

(check the position of the notch)

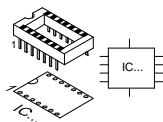

- IC1 : 18p
- IC2 : 8p
- IC3 : 14p
- IC4 : 14p

## 8. Capacitors.

Watch the polarity !

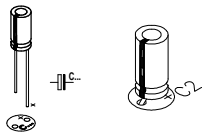

- C10 : 1 $\mu$ F
- C11 : 1 $\mu$ F
- C12 : 1 $\mu$ F
- C13 : 1 $\mu$ F
- C14 : 1 $\mu$ F
- C15 : 470 $\mu$ F

## 9. LED.

Watch the polarity !

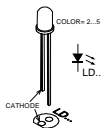

- LD2: 3mm

## 10. Transistors.

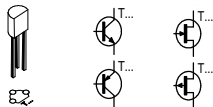

- T1: BF199
- T2: BC547
- T3: BC547

## 11. Capacitive trimmer

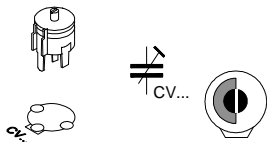

- CV1 : 5pF (5p5)

## 12. Voltage regulator

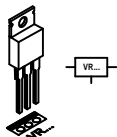

- VR1 : 7809

## 13. Screw connector

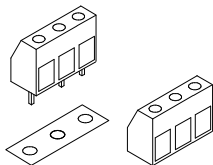

- J1 : 3 - pole
- J2 : 3 - pole
- J3 : 3 - pole



## 14. Relays

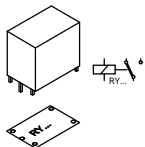

- RY1 : VR10V12

## 15. ICs

(check the position of the notch)

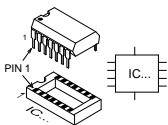

- IC1 : UM3758-120A
- IC2 : RV4558 - LM258 -  
2904
- IC3 : CD4013
- IC4 : CD40106

## 16. Sticker

Affix the supplied sticker to the housing.



## 17. Create your code

You can select your own code for a transmitter/receiver combination. There is a 9 row jumper island located directly next to IC1 for setting the code. The code is set by connecting one or more code points to a neighboring '+' or '-' point using the small jumpers. Code points may also be left unconnected (open): see figure.

a) No connection

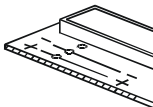

b) Code connection to '-'

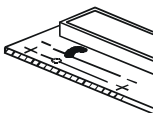

c) Code connection to '+'

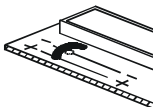

d) Example of a possible code

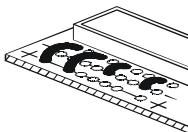

**Note:** certain points cannot be connected to '+'

## 18. Test and set-up

### **IMPORTANT:**

- A plastic screwdriver (including plastic blade) is needed to tune the transmitter or receiver. This is supplied with the receiver.
- The transmitter must be in its housing with the cover off.
- The receiver may not be in the vicinity of any metal objects.
- The transmitter and receiver must have the same code.
- If it is to be operated from push button SW1 of the transmitter, jumper CH1 of the receiver must be set. Otherwise, jumper CH2 must be set for operation from push button SW2.

### **1) Tuning receiver:**

- Set the tuning capacitor of the receiver to around the middle of its adjustment range.
- Check that the tuning LED of the receiver is not lit up, or is just on the verge of lighting up. If not, the tuning capacitor will have to be adjusted a little. Do not touch the circuit with your hand.

### **2) Tuning one or more transmitters to the receiver:**

- Activate the transmitter (**do not touch any other parts other than the push button**) and then (very carefully) turn the tuning capacitor until the tuning LED of the receiver lights up. If everything is correct, the relays should now switch, if of course the codes of the transmitter and receiver are the same.
- Now take the transmitter to a distance of about 10 metres from the receiver and repeat the test. Then the transmitter can be tested from around 20 metres (perhaps ask somebody to help you).
- If the transmitter cannot be tuned to the receiver, then it might be that the tuning capacitor of the receiver needs to be adjusted.

## 19. Connection

### 1. Connection to DC voltage :

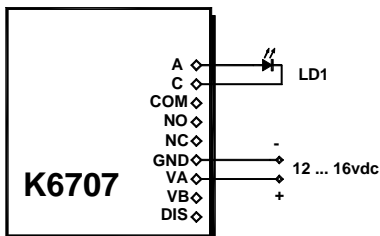

Fig. 1.0

E.g. : car battery

### 2. Connection to AC voltage :

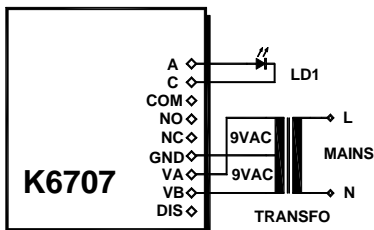

Fig. 2.0

E.g. : 2 x 9VAC / 100 mA Transformer

### 3. Other connections :

When using the relay output there is a choice between a normally closed contact (NC) or a normally open contact (NO). The common output is at COM.

#### 4. Connection to the K3504 car alarm :

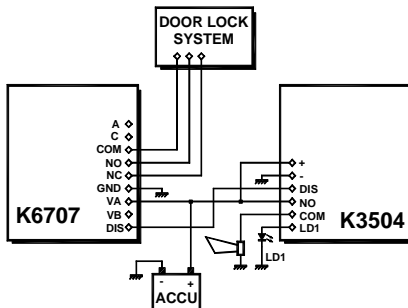

Fig. 3.0

For connection to the K3504 car alarm the DIS points of both circuits must be connected together. In this case the "DIS" connection of the car alarm must not be connected to the contact lock. For remote controlled operation of the car alarm, the SWITCHING TIME (IN and OUT) can be set to minimum. The free relay contacts can be still be used to operate the central locking system for example.

For indication purposes, LED LD1 can be mounted somewhere on the dashboard using the LED holder supplied. When the relay is closed the LED will flash, when open it is continuously lit.

#### NOTE

The circuit can also be installed in a plastic housing.

For installation in the car, the circuit can be mounted somewhere under the dashboard, and preferably in a place where there are few metal parts. It may be the case that after installation in the car, the circuit will have to be retuned. This is because of the influence of metal parts in the vicinity of the circuit. Because of the earth screen in a car, the transmitter/receiver range will be approximately halved which in most cases is more than sufficient.

## PCB layout.

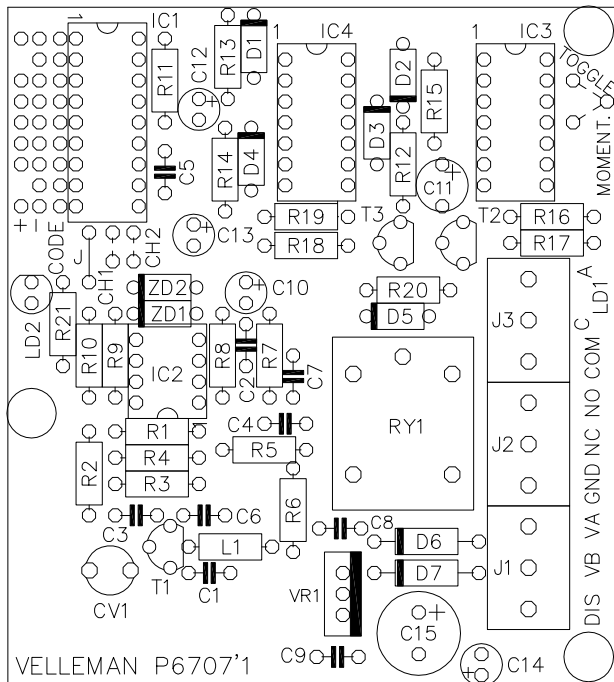



Modifications and typographical errors reserved  
© Velleman Components nv.  
H67071P - 2002 - ED2