

HR-95

Teža za meter 0,140 kg/m

Primeren za tranzistorje: TO 220, SOT 32

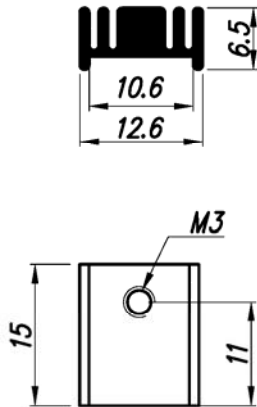

HR-95/15 SOT32

38,5 K/W

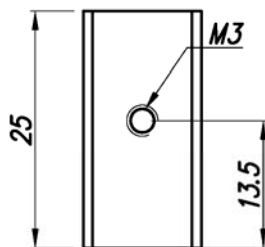

HR-95/25 SOT32

36 K/W

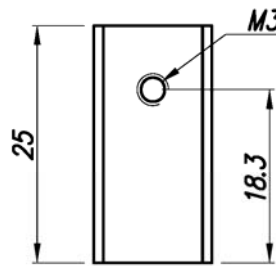

HR-95/25 TO220

36 K/W

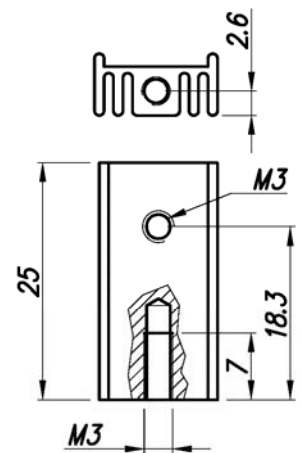

HR-95/25 TO220

2x M3
36 K/W

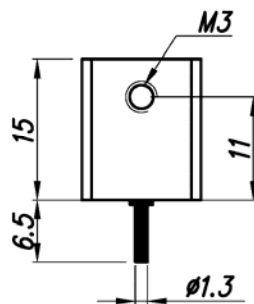
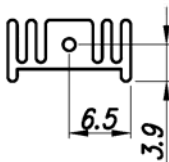

HR-95/15+PIN
SOT32
38,5 K/W

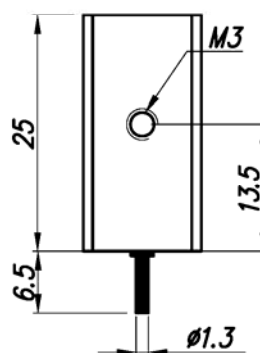

HR-95/25+PIN
SOT32
36 K/W

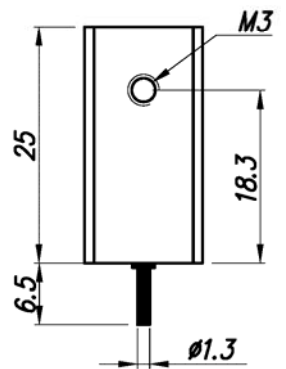

HR-95/25+PIN
TO220
36 K/W