

# ELECTROLYTIC CAPACITORS





# INDEX

## MINIATURE ALUMINUM ELECTROLYTIC CAPACITORS

27	SS [ For Super Miniature ]	1,000hrs. at 105°C
29	SS [ For Super Miniature ]	1,000hrs. at 105°C
31	SK [ For General ]	2,000hrs. at 85°C
36	SE-K [ For General ]	1,000hrs. at 105°C
41	SH [ For General ]	2,000hrs. at 105°C
45	SG [ Electronic Ballast ]	5,000hrs. at 105°C
48	SP [ Miniature and Long Life ]	10,000hrs. at 105°C
50	SB [ For Low Leakage Current ]	1,000hrs. at 105°C
54	SN [ For Non-Polar ]	1,000hrs. at 105°C
58	SR [ For Horizontal Deflection ]	1,000hrs. at 105°C
60	SC [ Low Impedance and Low ESR Suitable for Motherboard Output Termination ]	3,000hrs. at 105°C
64	SJ [ Low Impedance and High Ripple Series ]	1,000–5,000hrs. at 105°C
69	SQ [ For Adapter and Power Supply Applications Series ]	2,000hrs. at 105°C
72	SY [ For Low Impedance and Low ESR Suitable for Motherboard Output Termination ]	3,000–6,000hrs. at 105°C
78	SZ [ Ultra Low ESR ]	2,000hrs. at 105°C
80	ST [ Low Impedance and Long Life ]	4,000–10,000hrs. at 105°C
83	SD [ For High Ripple Current ]	5,000hrs. at 105°C
85	SL [ Long Life and Low Impedance ]	3,000–7,000hrs. at 105°C
92	SU [ For Higher Temperature Range ]	2,000hrs. at 125°C
94	SW [ Higher Temperature Range and Long Life ]	2,000–5,000hrs. at 125°C

## LARGE CAN ALUMINUM ELECTROLYTIC CAPACITORS

97	LH [ For Miniature ]	2,000hrs. at 85°C
106	LG [ For General ]	2,000hrs. at 105°C
114	LV [ For Long Life ]	3,000hrs. at 105°C
121	LC [ High Temperature and Long Life ]	5,000hrs. at 105°C

## SURFACE MOUNT ALUMINUM ELECTROLYTIC CAPACITORS

124	CA [ For General ]	2,000hrs. at 85°C
128	CB [ For General ]	1,000hrs. at 105°C
132	CE [ For Long Life ]	2,000hrs. at 105°C
136	CZ [ For Low Impedance ]	1,000hrs. at 105°C
140	CD [ For Ultra Low Impedance ]	2,000hrs. at 105°C
143	CH [ Ultra Low Impedance and High Temperature ]	2,000hrs. at 125°C
146	CX [ Ultra Low Impedance and Long Life ]	3,000–5,000hrs. at 105°C

## CONDUCTIVE POLYMER SOLID CAPACITORS

149	CP [ Ultra Low ESR & High Ripple Current ]	2,000hrs. at 105°C
151	CG [ Low ESR & High Ripple Current ]	2,000hrs. at 105°C

## SCREW TYPE ALUMINUM ELECTROLYTIC CAPACITORS

154	NP [ For General ]	2,000hrs. at 85°C
159	NM [ For Wide Temperature ]	2,000hrs. at 105°C
164	NF [ Long Life for Inverter ]	5,000hrs. at 85°C
166	NH [ High Temperature, Long Life for Inverter ]	5,000hrs. at 105°C
171	NG [ For Low Voltage, Large Capacity ]	2,000hrs. at 85°C



## PRECAUTIONS IN USING ALUMINUM ELECTROLYTIC CAPACITORS

Please note the following recommendations when using capacitors:

1. When using Electrolytic capacitors on DC applications, polarization is required as well as the confirmation of the polarity of the course. Otherwise, the circuit life may be shortened or the capacitor may be damaged by the insertion on reverse polarity.  
Use non-polar capacitors on those circuits with occasionally reverse polarity or unknown polarity. Also note that do not use electrolytic capacitors for AC applications.
2. Do not apply a voltage exceeding the capacitor rated voltage, that will cause the capacitor be damaged by increased leakage current.
3. Use the electrolytic capacitor at current value under the permissible ripple range.
4. Use the electrolytic capacitors according to the specified operation temperature range. Using at room temperature will ensure a longer life.
5. The electrolytic capacitor is not suitable for circuits which are charged and discharged repeatedly. If used in circuits which are charged and discharged repeatedly, the capacitance value may drop or the capacitor may be damaged. Please consult our engineering department for assistance in these applications.
6. When capacitors have been left unused for a long time, use them only after due voltage treatments. Long storage time may raise capacitor's leakage current level. In such cases, be sure to provide the necessary voltage treatment before use.
7. Be careful of the temperature and time conditions when soldering. Adverse effects may happen on the electrical characteristics and insulation sleeve of electrolytic capacitors may occur in case the soldering temperature is too high or dipping time too long. For small-size electrolytic capacitors, proper dipping shall be executed at temperature lower than 260°C for less than 10 seconds.
8. Clean circuit boards after soldering. Halogenated hydrocarbon cleaning solvents are not recommended to clean capacitors with exposed end seals. If halogenated solvent is required, order and use capacitors in Epoxy-coated end seals.

9. Do not apply excessive force to the lead wires or terminals. It may break the components or disconnect the internal elements on the board. (For strength of terminals, please refer to JIS C5102 and C5141.)
10. Keep the clearance between the vent of the capacitor and the case of the appliance. Do not block the operation of the vent, unless otherwise described on the catalogues or product specifications. The narrower clearance may adversely affect the vent operation and result in the capacitor explosion.

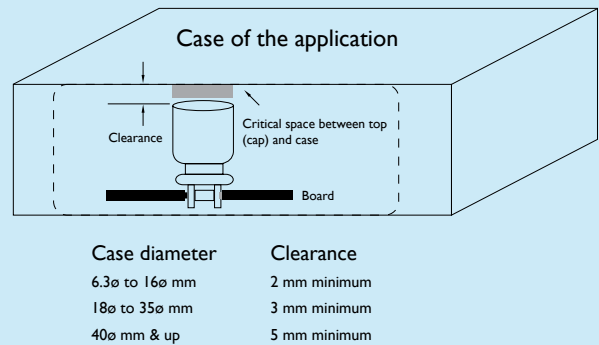

Fig. I-1

### Attention

- The description in this catalogue is subject to change without prior notice for product improvement. Therefore, please confirm the specification before ordering products.
- The general characteristics, reliability data, etc., described in this catalogue should not be construed as guaranteed values; they are merely standard values.
- Before using the products, please read the notes in this catalogue carefully for proper use.

## TECHNICAL CONCEPTS

### The Material and Structure of Electrolytic Capacitors

Electrolytic Capacitor is a simple module. It simply contains an insulator between relative conductors in an electrode. The major internal raw material contains an element constructed by a separator paper wrap around the anode foil and cathode foil, which is then impregnated with the electrolyte, inserted into an aluminum case and sealed.

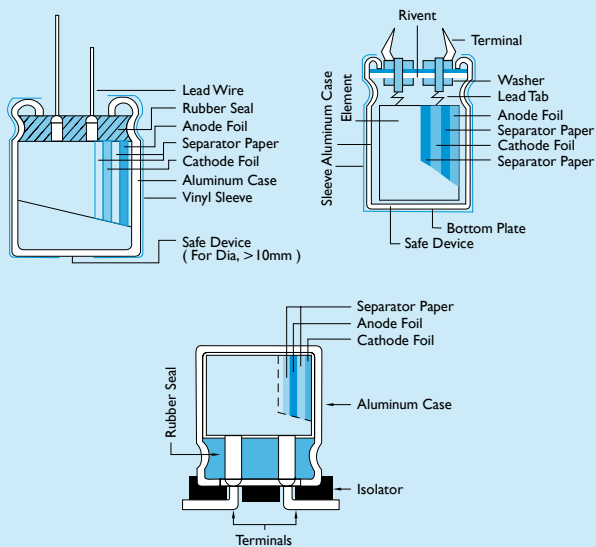

Fig. I-2

### Production Processes

1. Etching: The process to increase surface area of aluminum foil by using chemical erosion or chemical corrosion method is called Etching. Normally chemical corrosion method uses the ripple current of electrolyte, combination of the liquid and temperature to determine the size, shape, and quantity of the dense network of microscopic channels on the aluminum foil surface.
2. Forming: The production process of the anode aluminum foil of electrolytic capacitors is by anodic oxidation of the etched aluminum foil. The production of the cathode aluminum foil sometimes involves oxidation in special purposes. This anodic oxidation process is called Forming. Boric acid or organic acid is used for high voltage forming and phosphoric acid or ammonium adipose is used for low voltage forming in order to obtain stable natural oxide layer of  $Al_2O_3$ .
3. Slitting: The cutting of the aluminum foil and separator paper according to the required length.
4. Winding: The stitching or cold welding of cut anode and cathode foils and tab terminal, and wrap the electrolytic paper in between the anode and cathode, then fix the end with glue or sticky tape, and attached leads is called the capacitor "element".
5. Impregnation: The process of eliminating the water from the elements by pressurizes or vacuum in order to soak the element with the electrolyte is called Impregnation. The elements fully filled with electrolyte is then centrifuged to remove excess electrolyte.
6. Assembly: The elements are sealed with rubber to stop the leakage of electrolyte then put into a sleeve to form the final product.
7. Aging: The purpose of aging is to repair the oxide layer damage by recharging and electrolyte.



## THE FUNCTION OF ELECTROLYTIC CAPACITORS

---

The electrolytic capacitors could be widely used in appliance (ie. TV, radio, audio equipment, washing machine and air conditioner...etc.), computer equipment (motherboard, image device & the peripherals such as the printer; drawing device, scanner... etc.), communication equipment, estate equipment, measuring instrument and also the industrial instrument, air plane, firebomb, satellite...etc. as a piloting equipment.

\* According to the inflict electric wave & using purpose, it basically with some classified purposes as below:

### DC Voltage:

1. For Momentary High Voltage: For using to the impulse generator such as the shock wave resistance test of the heavy electric machine.
2. For High Electric Current: For using to the welding machine, X-Ray facility, copy machine and discharge-processing device.
3. For DC High Voltage: The electrolytic capacitor and rectifier composing, a special DC high voltage been happened after charged, for using to the power of electronic microscope and accelerator.
4. For Integration & Memory: For either memory circuit or compare circuit inside the calculator.

### The DC Voltage that with Alternate Ingredient:

1. For Wave Filter: Combination with the chip resistor & inductor as a internet, to be passed by DC current or some frequency to closure or decline some other frequency.
2. For Bypass: A parallel track that outside from the circuit element, the IC (integrated circuit) has been rapidly developed in these years and thus a miniaturization or chip of electrolytic capacitors for bypass was conducted.
3. For Coupling: Combination of the electrolytic capacitor; chip resistor and inductor and thus coupling together.
4. For Arising of Toothed Wave: Composing of RC charge/discharge circuit through the electrolytic capacitor as well as the resistor to generate a toothed wave to be created.
5. For Reverse (Change) of Circuit: The equipment for changing the AC voltage to DC voltage.

### For AC Voltage:

1. For Power Improving: Connect the end loading of layout transporting & electrolytic capacitor for power improving.
2. For Wave Filter: Prevention of external interference in SCR circuit, use the LC wave filter circuit to inhibit or erase the interference.
3. For Phase Across: Phase change of the inductive electromotor (motor) with single phase.

## BASIC ELECTRICAL CHARACTERISTICS

### Capacitance (ESC)

The capacitive component of the equivalent series circuit (equivalent series capacitance ESC) is determined by applying an alternate voltage of 0.5V at a frequency of 120 Hz.

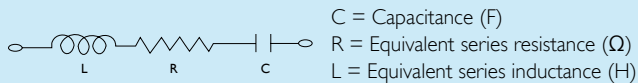

Fig. I-3 Simplified equivalent circuit diagram of an electrolytic capacitor

- Temperature Dependence of the Capacitance

The capacitance of an electrolytic capacitor depends on the temperature. With decreasing temperature, the viscosity of the electrolyte increases and reduces its conductivity which leads to the capacitance decrease. Furthermore temperature drifts cause armature dilatation and therefore capacitance changes (up to 20%, depending on the series considered, from 0 to 80 °C). This phenomenon is more evident on electrolytic capacitors than other types.

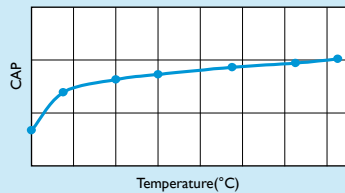

Fig. I-4 Capacitance Change vs. Temperature

- Frequency Dependence of the Capacitance

The effective capacitance value is derived from the impedance curve, as long as the impedance is still in the range where the capacitance component is dominant.

$$C = \frac{1}{2\pi fZ}$$

C = Capacitance (F)  
 f = Frequency (Hz)  
 Z = Impedance (Ω)

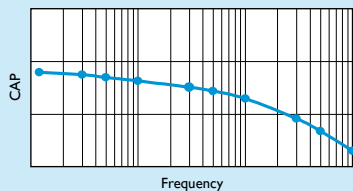
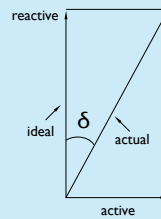

Fig. I-5 Capacitance Change vs. Frequency

### Dissipation Factor (tan δ)

The dissipation factor is the ratio between the active and the reactive power for a sinusoidal waveform voltage. It can be considered as a measurement of the gap between an actual and an ideal capacitor:



$$D.F. = \tan \delta \times 100 (\%) = \omega CR \times 100 (\%) = 2\pi fCR \times 100 (\%)$$

where: R = Equivalent Series Resistance  
 C = Equivalent Series Capacitance  
 $\omega = 2\pi f$

Fig. I-6 The tanδ is measured with the same set up as for the series capacitance ESC

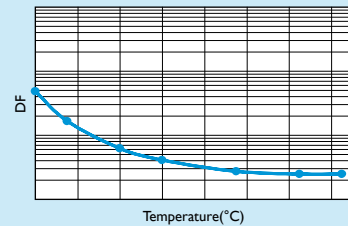

Fig. I-7 Dissipation Factor vs. Temperature

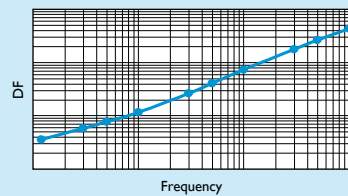

Fig. I-8 Dissipation Factor vs. Frequency



## BASIC ELECTRICAL CHARACTERISTICS

### Equivalent Series Resistance (ESR)

The equivalent series resistance is the resistive component of the equivalent series circuit. The ESR value depends on frequency and temperature and is related to the  $\tan \delta$  by the following equation:

$$ESR = \frac{\tan \delta}{2\pi f E S C}$$

ESR = Equivalent Series Resistance ( $\Omega$ )  
 $\tan \delta$  = Dissipation Factor  
 ESC = Equivalent Series Capacitance (F)  
 f = Frequency (Hz)

The tolerance limits of the rated capacitance must be taken into account when calculating this value.

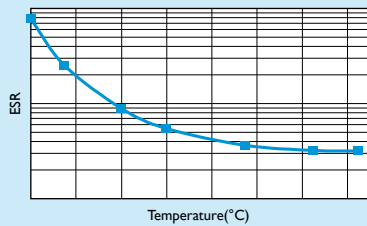

Fig. I-9 ESR Change vs. Temperature

The resistance of the electrolyte decreases strongly with increasing temperature.

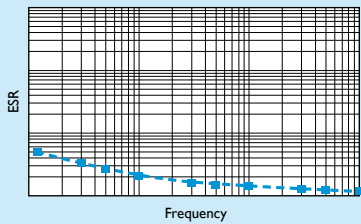

Fig. I-10 ESR Change vs. Frequency

### Impedance (Z)

The impedance of an electrolytic capacitor results from below circuit formed by the following individual equivalent series components.

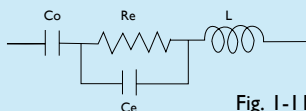

Fig. I-11

$C_o$  = Aluminum oxide capacitance (surface and thickness of the dielectric).

$R_e$  = Resistance of electrolyte and paper mixture (other resistances not depending on the frequency are not considered: tabs, plates, and so on).

$C_e$  = Electrolyte soaked paper capacitance.

$L$  = Inductive reactance of the capacitor winding and terminals.

The impedance of an electrolytic capacitor changes depending on the frequency and the temperature.

The impedance as a function of frequency (sinusoidal waveform) under a certain temperature can be represented as follows:

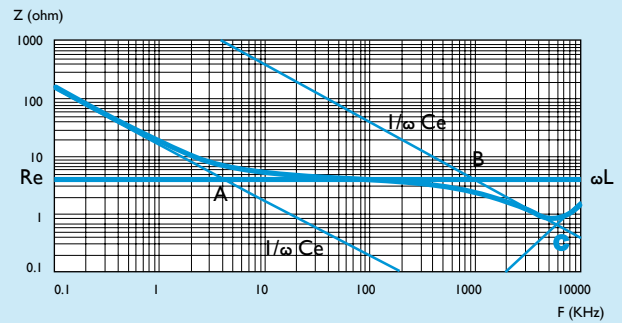

Fig. I-12

1. Capacitive reactance predominates at low frequencies
2. With increasing frequency, the capacitive reactance  $X_c = 1/\omega C_o$  decreases until it reaches the order of magnitude of the electrolyte resistance  $R_e$  (A)
3. At even higher frequencies, the resistance of the electrolyte predominates:  $Z = R_e$  (A-B)
4. When the capacitor's resonance frequency is reached ( $\omega_0$ ), capacitive and inductive reactance mutually cancel each other  $1/\omega C_e = \omega L$ ,  $\omega_0 = \sqrt{1/LC_e}$  (C)
5. Above this frequency, the inductive reactance of the winding and its terminals ( $X_L = Z = \omega L$ ) becomes effective and leads to an increase in impedance. Generally speaking it can be estimated that  $C_e \approx 0.01 C_o$



## BASIC ELECTRICAL CHARACTERISTICS

The impedance as a function of frequency (sinusoidal waveform) for different temperature values can be represented as follows (typical values):

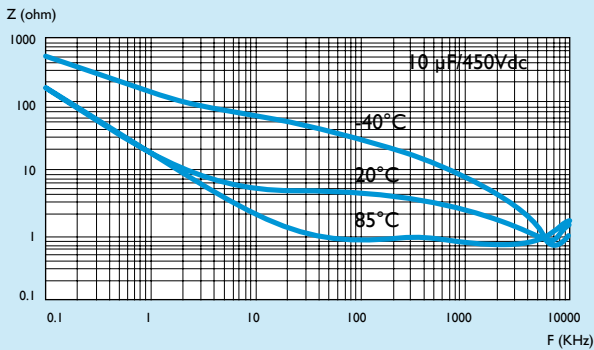

Fig. I-13

$R_e$  is the most temperature dependant component of electrolytic capacitor equivalent circuit. The electrolyte resistivity will decrease when the temperature rises. In order to obtain a low impedance value in all temperature range,  $R_e$  must be as little as possible, but too low  $R_e$  values means a very aggressive electrolyte and a shorter life of the electrolytic capacitor at the high temperatures. A compromise must be reached.

### Leakage Current (L.C.)

Due to the aluminum oxide layer that serves as a dielectric, a small current will continue to flow even after a DC voltage has been applied for long periods. This current is called leakage current. A high leakage current flows after applying a voltage to the capacitor and then decreases in few minutes (e.g. after a prolonged storage without any applied voltage). In the course of the continuous operation, the leakage current will decrease and reach an almost constant value. After a voltage free storage the oxide layer may deteriorate, especially at high temperature. Since there are no currents to transport oxygen ions to the anode, the oxide layer is not regenerated. The result is that a higher than normal leakage current will flow when a voltage is applied after prolonged storage. As the oxide layer is regenerated in use, the leakage current will gradually decrease to its normal level. The relationship between the leakage current and the voltage applied at constant temperature can be shown schematically as follows.

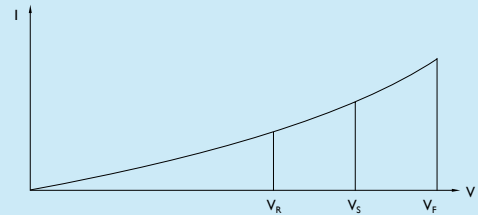

Fig. I-14

Where:

$V_F$  = Forming Voltage

If this level is exceeded, a large quantity of heat and gas will be generated and the capacitor could be damaged.

$V_R$  = Rated Voltage

This level represents the top of the linear part of the curve.

$V_S$  = Surge Voltage

It lies between  $V_R$  and  $V_F$ ; the capacitor can be applied with  $V_S$  for short periods only.



## RELIABILITY

### Bathtub Curve

Aluminum electrolytic capacitors failure rates are shown by the following bathtub curve.

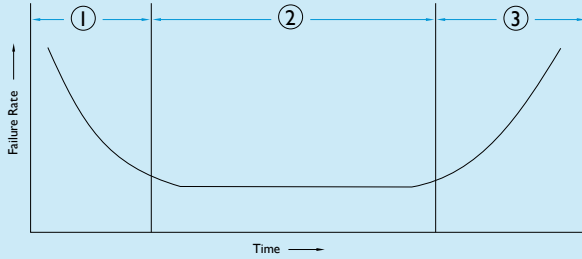

Fig. I-15 Bathtub Curve

1. Initial Failure Period  
Deficient Capacitors include any products before dispatch that may have some deficiency caused by the design, production process or use in inappropriate environments.
2. Random Failure Period  
The capacitors have a low defect ratio in the period after it has been stabilized.
3. Wear Out Failure Period  
The performance of capacitors will decrease with an increase in usage period. The malfunction rate may vary due to the structural design.

Table-I Failure Modes and Causes

Failure Modes	Internal Causes	Primary Factors		
		Mismanaged Production	Mishandled Application	Unavoidable Factors in Normal Service
Short Circuit	Short Circuit Between Electrodes	Burred Foil / Metal Particle		
	Dielectrical Break of Oxide Layer	Local Deficiency in Oxide Layer		
Open Circuit	Dielectrical Break of Separator		Mechanical Stress	
	Disconnection of Terminal Construction		Mechanical Stress	
Capacitance Drop	Poor Terminal Connection	Poor Connection		
	Less Electrolyte			Deterioration with Time
tanδ (ESR) Increase	Electrolyte Vaporization		Excessive Thermal Stress	
	Anode Foil Capacitance Drop		Excessive Operating Voltage	
Leakage Current Increase	Cathode Foil Capacitance Drop		Reverse Voltage	
	Deterioration of Oxide Layer		Excessive Ripple Current	
Open Vent	Corrosion		Excessive Charge-Discharge Duty	
	Internal Pressure Rise		Chloride Contamination by Assembly Board Cleaning	
Electrolyte Leakage	Poor Sealing			

## CIRCUIT DESIGN

### Environmental and Mounting Conditions

Please make sure the environmental and mounting conditions are compliant with their specifications in this catalog.

### Operating Temperature, Equivalent Series Resistance(ESR), Ripple Current and Load Life

MTTF(Mean-Time-To-Failure) means the useful life at room temperature 25°C

#### 1. Load Life ( $L_0$ )

If the capacitor's max. operating temperature is at 105 °C (85°C), then after applying capacitor's rated voltage (WV) for  $L_0$  hours at 10°C (85°C), the capacitor shall meet the requirements in detail specification. where  $L_0$  is called "load life" or "useful life (life time) at 105 °C (85°C)".

$$L_x = L_0 \times 2^{(T_0 - T_x) / 10} \times K^{-\Delta T_x / 5}$$

where  $\Delta T_x = \Delta T_0 \times (I_x / I_0)^2$

$$I_x > I_0, K = 4; I_x \leq I_0, K = 2$$

#### 2. Ripple Life ( $L_r$ )

If the capacitor's max. operating temperature is at 105 °C (85°C), then after applying capacitor's rated voltage (WV) with the ripple current for  $L_r$  hours at 105 °C (85°C), the capacitor shall meet the requirements in detail specification. where  $L_r$  is called "ripple life" or "useful ripple life (ripple lifetime) at 105 °C (85°C)".

$$L_x = L_r \times 2^{(T_0 - T_x) / 10} \times K^{(\Delta T_0 - \Delta T_x) / 5}$$

where  $\Delta T_x = \Delta T_0 \times (I_x / I_0)^2$

$$I_x > I_0, K = 4; I_x \leq I_0, K = 2$$

The (ripple) life expectancy at a lower temperature than the specified maximum temperature may be estimated by the following equation, but this expectancy formula does not apply for ambient below +40°C.

$L_0$  : Expected life period (hrs) at maximum operating temperature allowed

$L_r$  : Expected ripple life period (hrs) at maximum operating temperature allowed

$L_x$  : Expected life period (hrs) at actual operating temperature

$T_0$  : Maximum operating temperature (°C) allowed

$T_x$  : Actual operating ambient temperature (°C)

$I_x$  : Actual applied ripple current (mA/rms) at operating frequency  $f_0$  (Hz)

$I_0$  : Rated maximum permissible ripple current  $I_R$  (mA/rms) x frequency multiplier ( $C_f$ ) at  $f_0$  (Hz)

Ripple Current calculation: no need Temperature Multiplying Factor

$I_x$  Should be 80% equal or more of  $I_0$

$T_0$  : Maximum temperature rise (°C) for applying  $I_0$  (mA/rms) = 5

$T_c$  : Temperature rise (°C) of capacitor case for applying  $I_x$  (mA/rms)

$T_x$  : Temperature rise (°C) of capacitor element for applying  $I_x$  (mA/rms) =  $K_c \Delta T_c = K_c (T_c - T_x)$

where  $T_c$  is the surface temperature (°C) of capacitor case  $T_x$  is ditto.  $K_c$  is transfer coefficient between element and case of capacitor from table below :

Dia	≤8ø	10ø	12.5ø	13ø	16ø	18ø	22ø	25ø	30ø	35ø
Kc	1.10	1.15	1.20	1.20	1.25	1.30	1.35	1.40	1.50	1.65

#### 3. The Formula of Equivalent Series Resistance (ESR)

The operating frequency of ESR, DF, f & C must be the same, usually are 120 Hz.

$$ESR = DF / 2\pi f C \dots \dots \dots (2)$$

Where DF = Dissipation Factor (tanδ)

f = Operating Frequency (Hz)

C = Capacitance (F)

#### 4. Estimation of Life Considering the Ripple Current

The ripple current affects the life of a capacitor because the internal loss (ESR) generates heat. The heat can be calculated by:

$$P = I^2 R \dots \dots \dots (3)$$

Where I = Ripple current (Arms.)

R = ESR (Ω)

#### 5. Estimation of the Capacitor Temperature Increase

$$\Delta T = I^2 R / AH \dots \dots \dots (4)$$

Where  $\Delta T$  = Temperature increase in the capacitor core (degree)

I = Ripple current (Arms)

R = ESR (Ω)

A = Surface area of the capacitor (cm<sup>2</sup>)

H = Radiation coefficient (Approx. 1.5~2.0\*10<sup>-3</sup> W / cm<sup>2</sup>)

The values of  $\Delta T$  varies depending on the capacitor types and operating conditions. The usage is generally desirable if  $\Delta T$  remains less than 5°. The measuring point for temperature increase due to ripple current is shown below

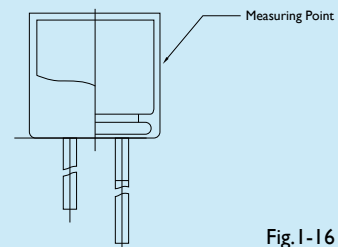

Fig. I-16



## CIRCUIT DESIGN

---

### Conditions of Use

Aluminum Electrolytic Capacitors must not be used under the following conditions:

1. When capacitors expose to high humidity or humidity condensation situation such as water or saltwater spray, oil spray, steam.
2. When capacitors are exposed to toxic gases such as hydrogen sulfide, sulfurous acid, nitrous acid, chlorine, ammonium... etc.
3. When capacitors are exposed to ozone, ultraviolet rays and radiation.
4. When severe vibration or shock occurs and exceeds the conditions specified in the catalog or datasheet.
5. Aluminum Electrolytic Capacitors should be electrically isolated from the following circumstances
  - Aluminum case, cathode lead wire, and anode lead wire.
  - Auxiliary terminals of snap-in type, anode terminal, and outward terminal.

### Recommended Design Considerations

When designing a circuit board, please be noted to the following points:

1. Make the hole spacing of the PC board match the lead space for the capacitor.
2. There should not be any circuit pattern or circuit wire above the capacitors.
3. It is suggested to make a gas release hole when the capacitor's vent is placed toward the PC board.
4. Do not install screw terminal capacitor upside down. When place a screw terminal capacitor in a horizontal mount, the positive terminal must be in the upper position.
5. Do not locate any wiring or circuit patterns directly above the capacitor's vent.

## CAUTION FOR MOUNTING

---

### Caution Before Assembly

1. When the capacitors that are removed from PC board for the measuring electrical characteristics purpose at a periodical inspection, can be recycled to the same position. However; when mounting and applying electricity in unit, the capacitors cannot be recycled afterwards.
2. Aluminum Electrolytic Capacitors may accumulate charge during storage. In this case, discharge through a 1K $\Omega$  resistor before use.
3. Leakage current of Aluminum Electrolytic Capacitors may be increased during long storage time. In this case, the capacitors should be subjected to voltage treatment through a 1K $\Omega$  resistor before use.

### In the Assembly Process

1. Please confirm ratings before installing capacitors on the PC board.
2. Please confirm polarity before installing capacitors on the PC board.
3. Do not make capacitors drop on the floor or use a dropped capacitor:

4. Be careful not to deform the capacitor during installation.

5. The snap-in type of capacitors should be mounted firmly on the PC board without a gap between the capacitor body and the surface of PC board.
6. Avoid excessive force when clinching lead wire during auto-insertion process.
7. Avoid excessive shock to capacitors by automatic insertion machine, during mounting, parts inspection or centering operations.
8. Please utilize supporting material such as strap or adhesive to mount capacitors to PC board when it is anticipated that vibration or shock is applied.

### Soldering

1. All YAGEO's cp wires of electrolytic capacitors are lead free. (Pb).
2. Soldering conditions (temperatures, times) should be within the specified conditions which are described in the catalog or specification sheets.

## CAUTION FOR MOUNTING

3. If it is necessary that the leads must be formed due to a mismatch of the lead space to hole space on the board, bend the lead prior to soldering without applying too much stress to the capacitor.
4. If soldering capacitor has to be withdrawn from the PW board by soldering iron, the capacitor should be removed after the solder has melted completely in order to avoid stress to the capacitor or lead wires.
5. Soldering iron should never touch the capacitor's body.

### Flow Soldering

1. Do not dip capacitor's body into melted solder.
2. Din of flow soldering for the capacitors should be limited at 260°C, 10 seconds.
3. Flux should not be adhered to capacitor's body but only to its terminals.
4. Other devices which are mounted near capacitors should not touch the capacitors.

### Reflow Soldering Condition

1. For reflow, use a thermal condition system such as infrared radiation or hot blast. Vapor heat transfer systems are not recommended.
2. Observe proper soldering conditions (i.e. temperature, time, etc.)
3. Do not exceed the specified limits.
4. Repeated reflowing :
  - \* Avoid reflowing twice if possible.
  - \* If repeated reflowing is unavoidable, contact Yageo after measuring the first and the second reflow profiles and reflow interval at your side.

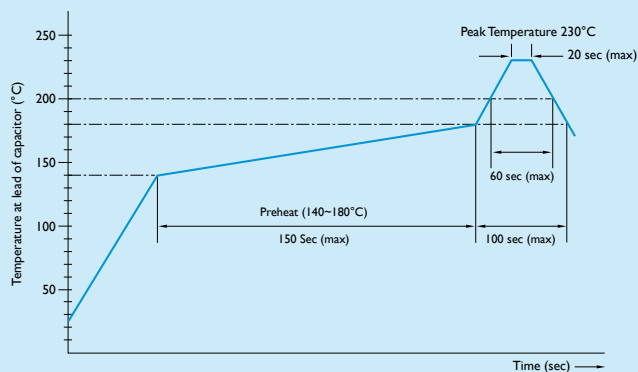

Fig. I-17 Reflow Soldering Condition

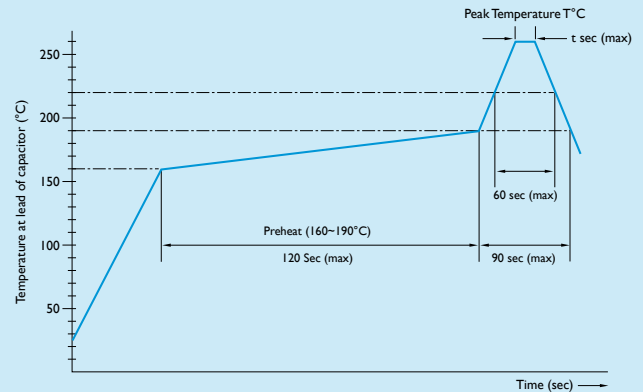

Fig. I-18 Lead Free Type Reflow Soldering Condition

SIZE	Temperature	t sec (max.)
ø4 ~ ø5 (4V ~ 50V)	250	10
	260	5
ø6.3 ~ ø10 (4V ~ 50V)	250	5

### Cleaning

1. Satisfied characteristic of JIS C 5101.
2. Aluminum Electrolytic Capacitors may be damaged by corrosion that is caused by any halogenated hydrocarbon solvents Ex: HCH(Cl)2. All of our products are non-solvent-proof, cleaning recommendation are as followed.  
 Application: An type and rating  
 Cleaning agents: pine Alpha ST-100S, Clean Through 750H/750L/710M, Sanelek B-12, Aqua Cleaner 210SEP, Techno Care FRW14~17, Iso-propyl Alcohol  
 Cleaning conditions: Total cleaning time shall be within 5 minutes by immersion, ultrasonic or other method. (Temperature of the cleaning agent shall be 60°C or lower). After cleaning, capacitors should be dried using hot air for minimum of 10 minutes along with the PC board.

Hot air temperature should be below the maximum operating temperature of the capacitor. Insufficient drying after water rinse may cause appearance problems, sleeve may shrink, or the bottom-plate may bulge, etc...

Please inform Yageo in advance the solvent name and conditions for your PWB Cleaning.



## EMERGENCY ACTION

---

1. If you see smoke due to the operation of safety vent, turn off the main switch or pull out the plug.
  2. Do not put your face near the safety vent as gas which is over 100°C will be emitted when the safety vent operates. If the gas has entered your eyes, please rinse your eyes immediately with water. If you breathe in the gas, immediately wash out your mouth and throat with water. Do not ingest electrolyte. If your skin is exposed to electrolyte, please wash it immediately with soap and water.
- 

## STORAGE CONDITION

---

1. Aluminum electrolytic capacitors should not be stored in high temperatures or high level of humidity. The suitable storage condition is 5 °C ~ 35 °C and less than 75% in relative humidity.
  2. Aluminum electrolytic capacitors should not be stored in damp conditions such as water, saltwater spray or oil spray.
  3. Do not store aluminum electrolytic capacitors in an environment full of hazardous gases (hydrogen sulfide, sulfurous acid, nitrous acid, chlorine, ammonium, etc.)
  4. Aluminum electrolytic capacitors should not be stored under exposure to ozone, ultraviolet rays or radiation.
  5. If a capacitor has been stored more than a year under normal temperature (shorter time if higher temperature) and it shows increased leakage current, then a treatment by voltage application is recommended.
- 

## ENVIRONMENT – RELATED SUBSTANCES

---

All YAGEO capacitors comply to RoHS requirements (Restriction of Hazardous Substances) where Chromium VI (Cr+6), Cadmium (Cd), Mercury (Hg), Lead (pb), polybrominated biphenyls (PBBs) and Polybrominated biphenyl/diphenyl ethers (PBBEs / PBDEs) have not detected (lower than MDL(Method Detection Limit)) per SGS certification test report.

---

## DISPOSAL

---

Please dispose capacitors in either of the following ways:

1. Incinerate the capacitors after making a hole on the capacitor body.
  2. A capacitor disposal specialist in burying procedure handling is recommended.
-

## THE CHARACTERISTICS OF ENDURANCE TEST

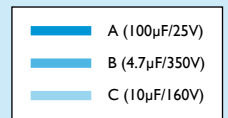
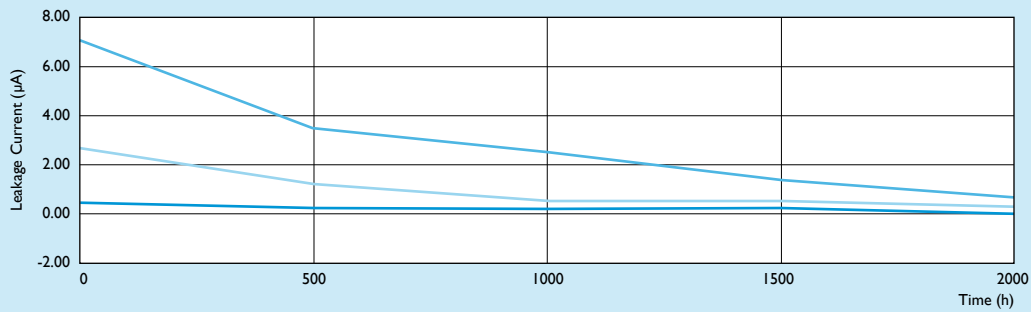
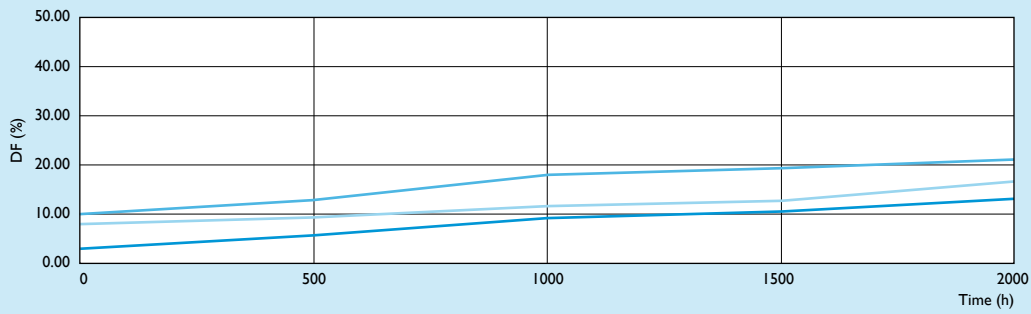
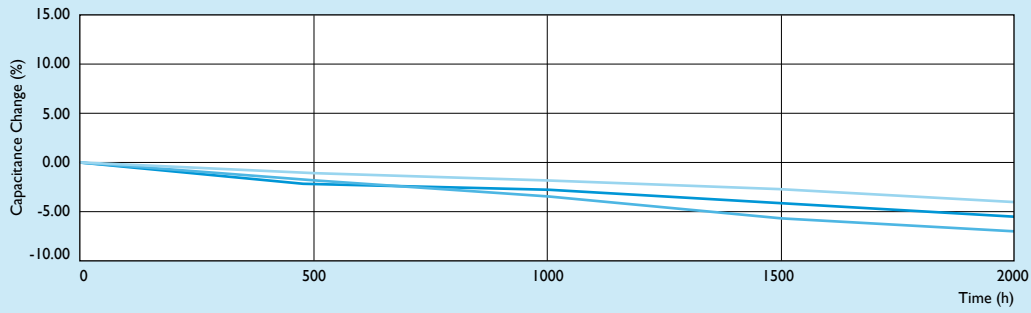



## MINIATURE & POLYMER ORDERING CODE

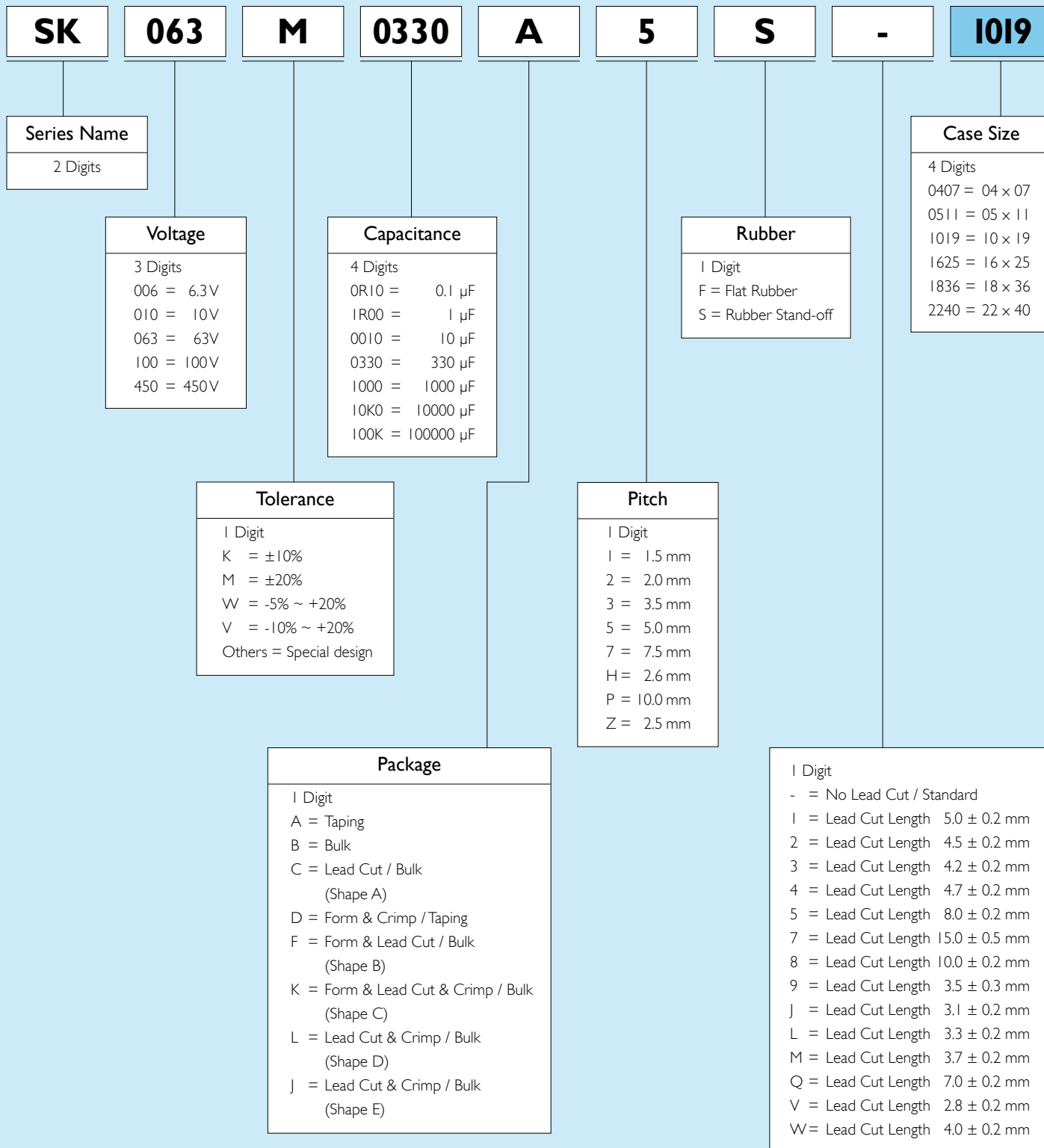



## LARGE CAN ORDERING CODE

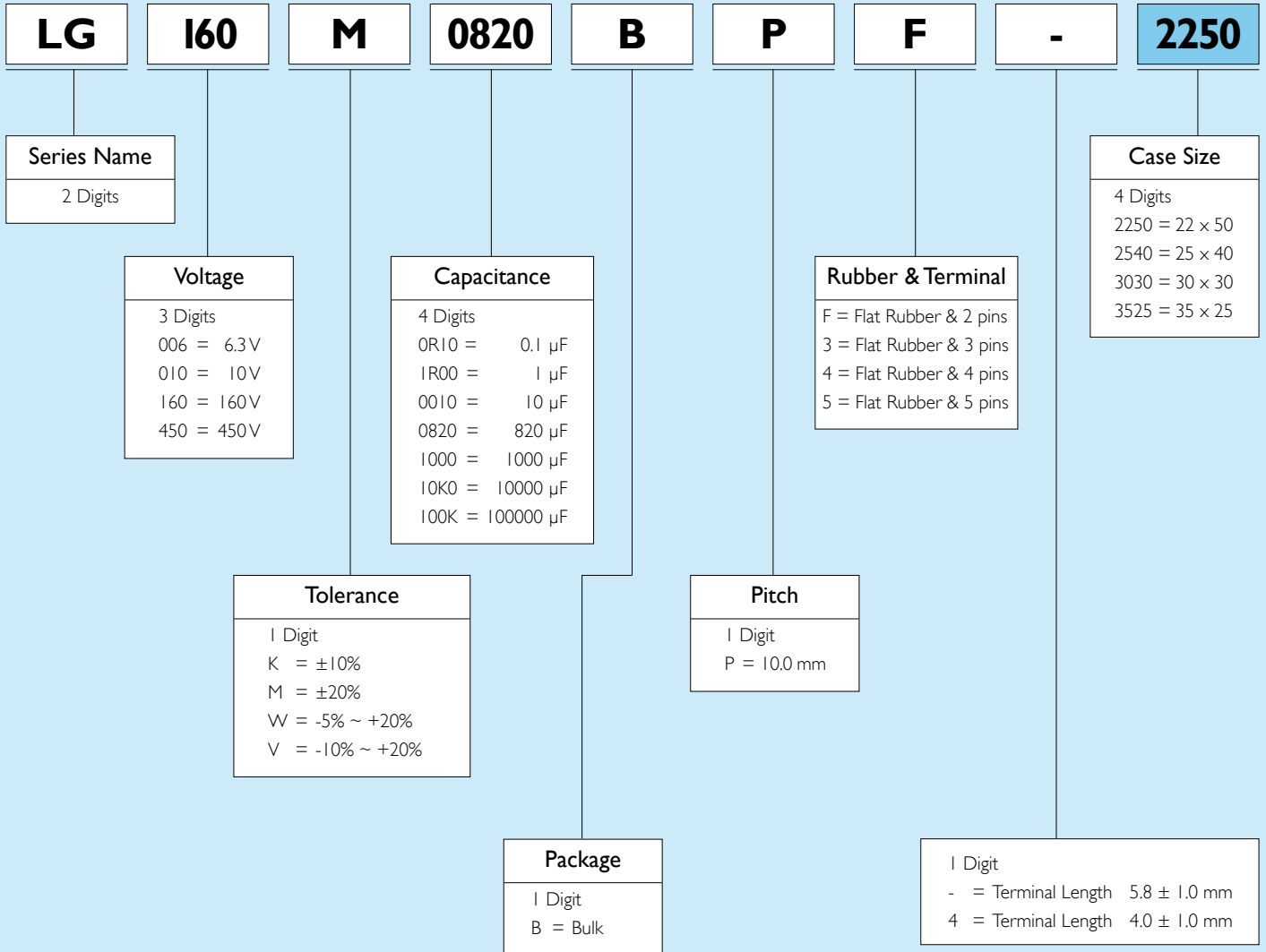



## SURFACE MOUNT ORDERING CODE

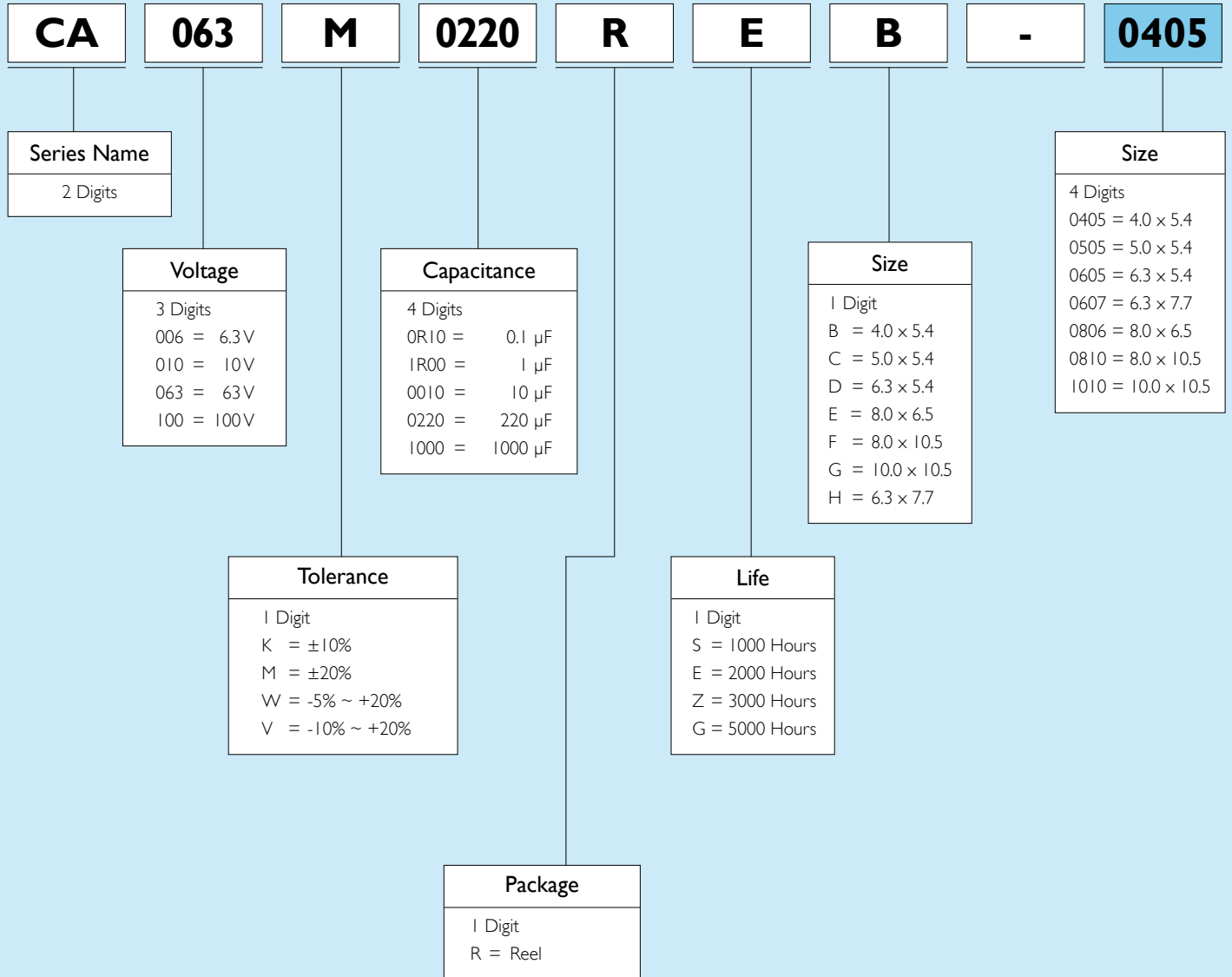

## SCREW TYPE ORDERING CODE

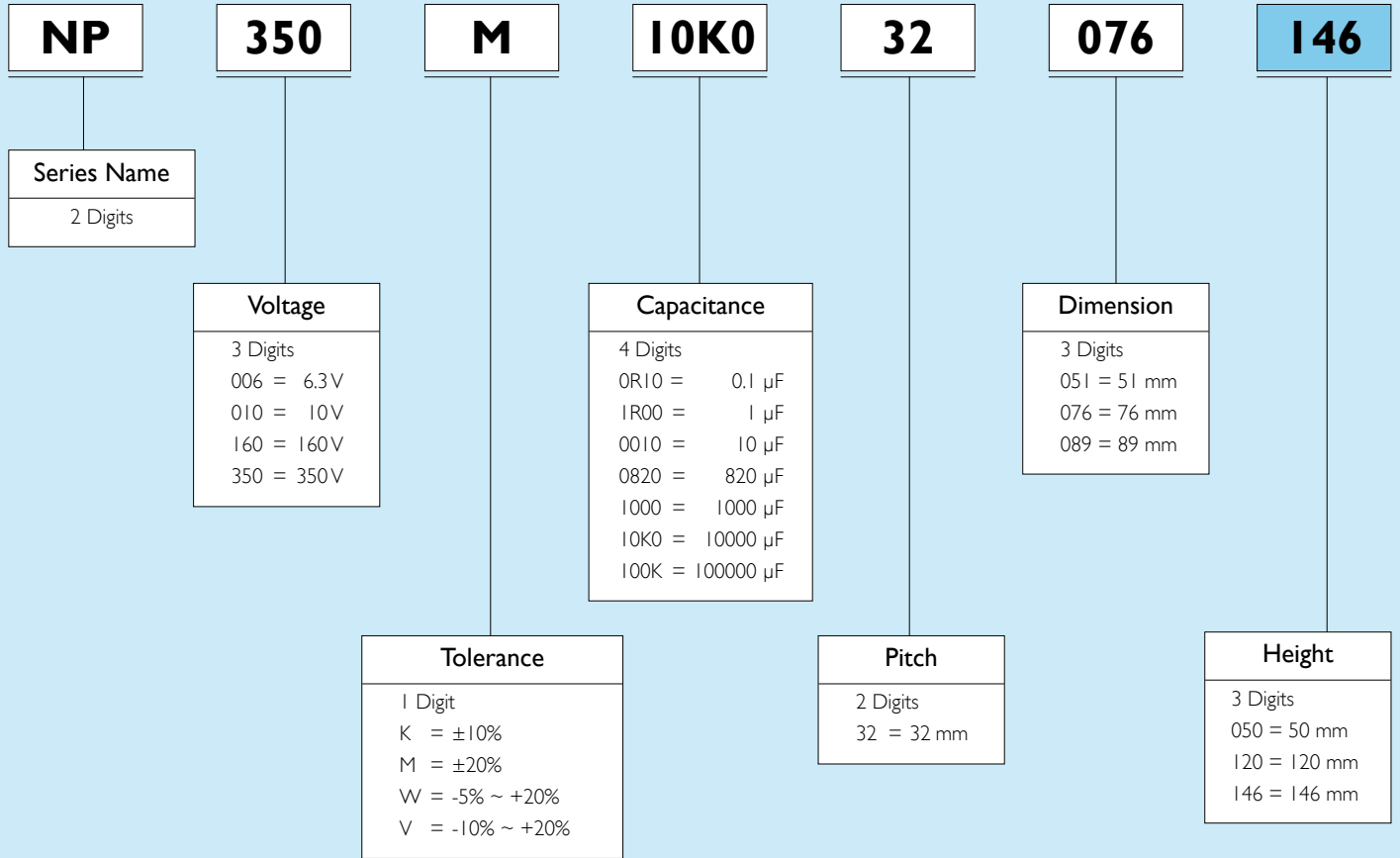



## PACKAGE INFORMATION

D x L: mm

RADIAL TYPE	BULK			TAPING		LEAD CUTTING		
	BAG/PCS	INNER BOX	CARTON	INNER BOX	CARTON	BAG/PCS	INNER BOX	CARTON
04 x 05	1000	10,000	20,000	2,500	25,000	1000	15,000	30,000
05 x 05	1000	10,000	20,000	2,000	20,000	1000	15,000	30,000
06 x 05	1000	10,000	20,000	2,000	20,000	1000	15,000	30,000
04 x 07	1000	10,000	20,000	2,500	25,000	1000	15,000	30,000
05 x 07	1000	10,000	20,000	2,000	20,000	1000	15,000	30,000
06 x 07	1000	10,000	20,000	2,000	20,000	1000	15,000	30,000
05 x 11	500	10,000	20,000	2,000	20,000	500	15,000	30,000
06 x 11	500	10,000	20,000	2,000	20,000	500	15,000	30,000
08 x 11	500	6,000	12,000	1,000	10,000	500	8,000	16,000
08 x 15	500	5,000	10,000	1,000	10,000	500	5,000	10,000
08 x 20	200	4,000	8,000	1,000	10,000	200	4,000	8,000
10 x 12	200	4,000	8,000	700	7,000	200	4,000	8,000
10 x 15	200	3,000	6,000	700	7,000	200	4,000	8,000
10 x 16	200	3,000	6,000	700	7,000	200	4,000	8,000
10 x 19	200	2,400	4,800	700	7,000	200	3,000	6,000
10 x 25	200	2,400	4,800	700	7,000	200	2,400	4,800
10 x 27	200	2,000	4,000			200	2,000	4,000
10 x 30	200	2,000	4,000			200	2,000	4,000
12 x 20	200	2,000	4,000	500	5,000	200	2,000	4,000
12 x 25	200	1,800	3,600	500	5,000	200	1,800	3,600
12 x 30	200	1,200	2,400			200	1,600	3,200
12 x 35	200	1,000	2,000				500	3,000
12 x 40	200	1,000	2,000				500	3,000
13 x 20	200	1,800	3,600	500	5,000	200	1,800	3,600
13 x 25	200	1,400	2,800	500	5,000	200	1,400	2,800
13 x 30	200	1,200	2,400				500	3,000
13 x 40	200	1,000	2,000				500	3,000
16 x 25	200	1,000	2,000	300	3,000		500	4,000
16 x 32	200	1,000	1,600				500	3,000
16 x 36	200	600	1,200				500	3,000
16 x 40	200	600	1,200				500	3,000
18 x 20	200	800	1,600			200	1,000	2,000
18 x 25	200	800	1,600				500	2,000
18 x 32	100	500	1,000				500	2,000
18 x 36	100	500	1,000				500	2,000
18 x 40	100	300	1,000				500	2,000
22 x 40	100	300	600				400	800

SNAP-IN TYPE	INNER BOX	CARTON
22 x 25 ~ 45	400	800
25 x 25 ~ 50	200	800
30 x 25 ~ 35	200	800
30 x 40 ~ 50	200	800
35 x 30 ~ 50	200	800

SMD TYPE	REEL	CARTON
4 x 5	2,000	20,000
5 x 5	1,000	10,000
6 x 5	1,000	10,000
6 x 7	1,000	10,000
8 x 6	1,000	10,000
8 x 10	500	3,000
10 x 10	500	3,000

# DIAGRAM OF TAPING DIMENSIONS

Unit: mm

Fig. 1

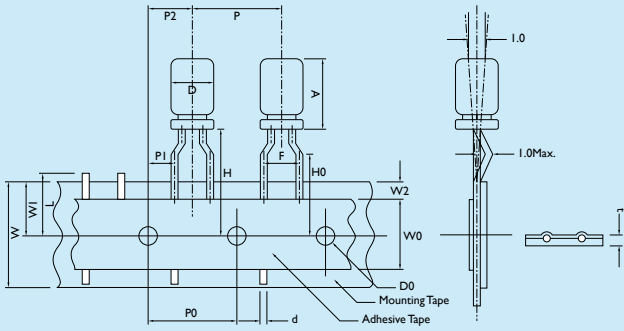

Fig. 4

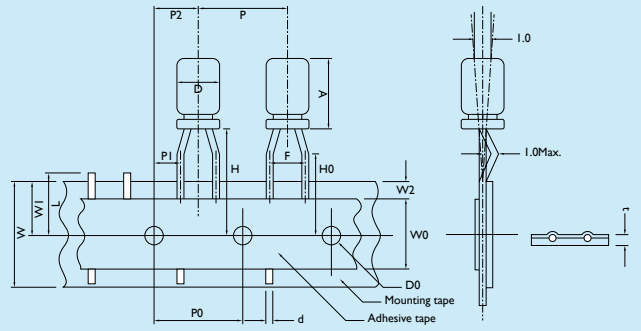

Fig. 2

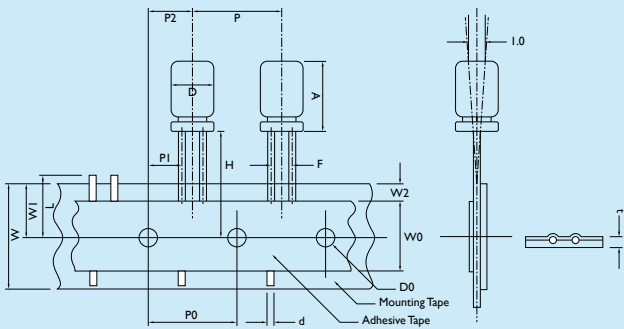

Fig. 5

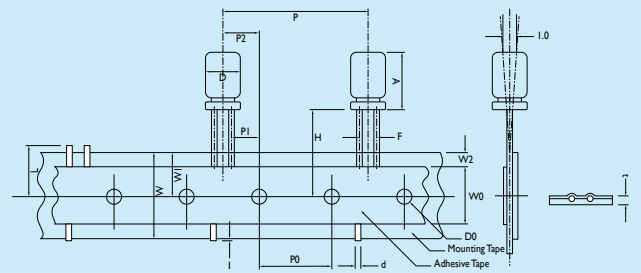

Fig. 3

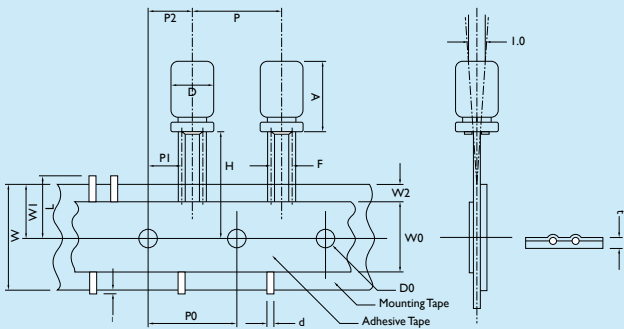
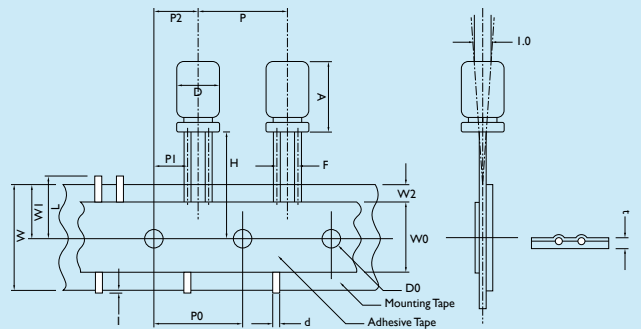

Fig. 6





## SPECIFICATIONS INFORMATION

Unit: mm

ITEM	TOLERANCE	PH = 2.5		FORMED LEAD TYPE						STRAIGHT LEAD TYPE										
		L		L						L										
		5~7	≤7 >7	5~7	≤7 >7	≤7 >7	≤7 >7	≤7 >7	5~7	≤7 >7	≤7 >7	≤7 >7	≤7 >7	≤7 >7	12~25	15~25	15~25			
D	+0.5, -0	4ø	5ø	4ø	5ø	6ø	8ø		4ø	5ø	6ø	8ø		10ø	12ø	12.5ø	13ø	16ø	18ø	
A	Max.	8.0	13	8.0	13	8.0	13	8.0	22.0	8.0	13	8.0	13	8.0	22.0	27.0				
d	±0.05	0.45	0.5	0.45	0.5	0.5	0.5	0.5	0.5	0.45	0.5	0.5	0.5	0.5	0.5	0.6				0.8
P	±1.0	12.7		12.7						12.7								15.0	30.0	
P0	±0.3	12.7		12.7						12.7								15.0		
P1	±0.7	5.1		3.85						5.6	5.35	5.1	4.6	5.0					3.75	
P2	±1.3	6.35		6.35						6.35						7.5				
F	+0.6, -0.2	2.5		5.0						1.5	2.0	2.5	3.5	5.0					7.5 ± 0.8	
W	+1.0, -0.5	18.0		18.0						18.0										
W0	±0.5	12.0		12.0						12.0										
W1	±0.5	9.0		9.0						9.0										
W2	Max.	3.0		3.0						3.0										
H	±0.75	18.5		18.5						18.5										
H0	±0.5	16.0		16.0						-										
I	Max.	-		-						-				1.0						
D0	±0.2	4.0		4.0						4.0										
t	±0.2	0.7		0.7						0.7										
L	Max.	11.0		11.0						11.0										
<b>Fig.</b>		<b>4</b>		<b>I</b>						<b>2</b>				<b>3, 6</b>				<b>5</b>		

## DIAGRAM OF LEAD CUTTING AND FORMING

Unit: mm

Shape (A)

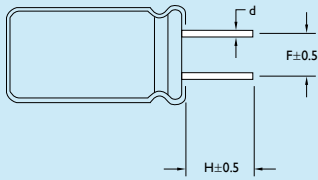

Shape (B)

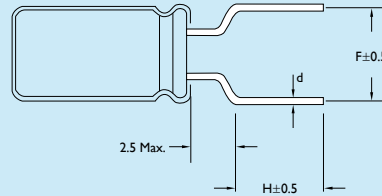

Shape (C)

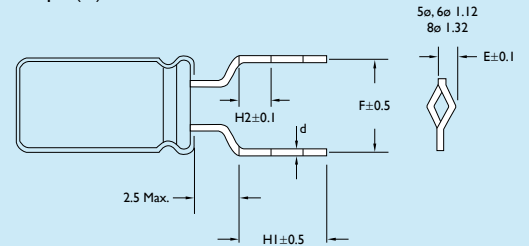

Shape (D)

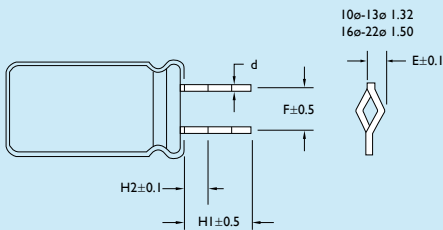

Shape (E)

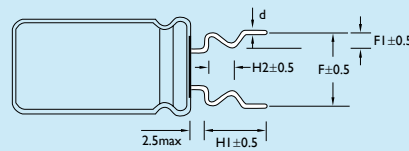

## SPECIFICATIONS INFORMATION

Unit: mm

### NO. CUTTING & FORMING METHODS

		Dø	4ø	5ø	6ø	8ø	10ø	12ø	13ø	16ø	18ø	22ø			
A	Lead Cut Only	F	1.5	2.0	2.5	3.5	5.0	5.0	5.0	7.5	7.5	10			
		H	5.0	5.0	5.0	5.0	5.0	5.0	5.0	5.0	5.0	5.0			
		d	0.45	0.5	0.5	0.5	0.6	0.6	0.6	0.8	0.8	0.8			
B	Lead Cut and Form	F	5.0	5.0	5.0	5.0									
		H	5.0	5.0	5.0	5.0									
		d	0.45	0.5	0.5	0.5									
C	Lead Cut, Crimp and Form	F	5.0	5.0	5.0	5.0	5.0	5.0	5.0	5.0	5.0	5.0			
		H1	5.0	4.2	5.0	4.2	4.0	5.0	4.2	4.0	5.0	4.2	4.0		
		H2	2.5	2.0	2.5	2.0	2.0	2.5	2.0	2.0	2.5	2.0	2.0		
		d	0.45	0.5	0.5	0.5	0.5	0.5	0.5	0.5	0.5	0.5	0.5		
D	Lead Cut and Crimp	F				5.0	5.0	5.0	5.0	7.5	7.5	7.5	10		
		H1				2.5	5.0	4.2	4.0	5.0	4.2	4.0	5.0	4.2	4.0
		H2				3.5	2.5	2.0	2.0	2.5	2.0	2.0	2.5	2.0	2.0
		d				0.5	0.6	0.6	0.6	0.8	0.8	0.8			
E	Lead Cut Form and Crimp	F	5.0	5.0	5.0	5.0									
		F1	1.2	1.2	1.2	1.2									
		H1	4.0	4.0	4.0	4.0									
		H2	1.8	1.8	1.8	1.8									
		d	0.45	0.5	0.5	0.5									



## CARRIER TAPE DIMENSION

Unit: mm

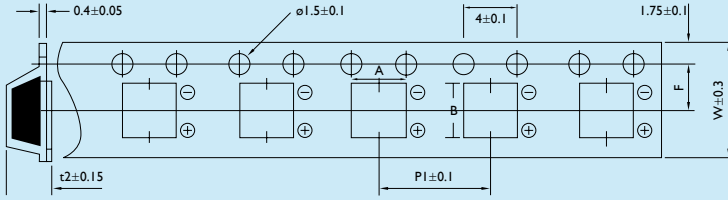

CASE SIZE	( $\phi D$ mm)	W	A	B	P1	F	t2
B	$\phi 4$	12.0	4.7	4.7	8.0	5.5	5.8
C	$\phi 5$	12.0	5.7	5.7	12.0	5.5	5.8
D	$\phi 6.3 \times 5.4$	16.0	7.0	7.0	12.0	7.5	5.8
E	$\phi 8 \times 6.5$	16.0	8.7	8.7	12.0	7.5	6.8
F	$\phi 8 \times 10.5$	24.0	8.7	8.7	16.0	11.5	11.0
G	$\phi 10 \times 10.5$	24.0	10.7	10.7	16.0	11.5	11.0
H	$\phi 6.3 \times 7.7$	16.0	7.0	7.0	12.0	7.5	8.0

## REEL DIMENSION

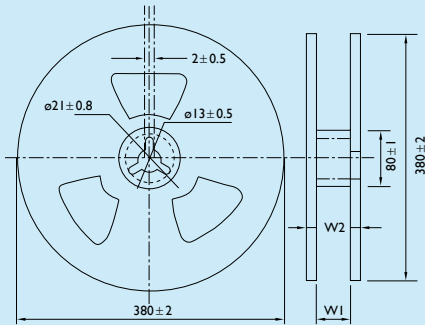

SIZE CODE	B	C	D	E	F	G	H
W1±1	14	14	18	18	26	26	18
W2±1	20	20	24	24	32	32	24



## DETAILS OF CARRIER TAPE SPECIFICATION

(1) Details of carrier tape

- a. Last reeling empty part of carrier tape shall be more than 10 cm
- b. Leader part of seal tape shall be more than 20 cm
- c. First reeling empty part of carrier tape shall be more than 10 cm
- d. Adhesive tape fixing the end of the leader part shall be approx 10 cm

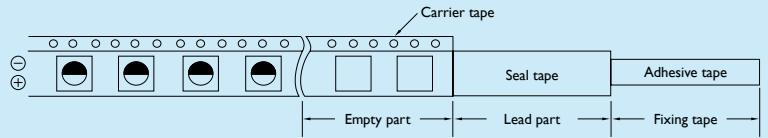

(2) Deviation between carrier tape and seal tape

- a. Deviation between carrier tape and seal tape shall be less than 0,5 mm
- b. Seal tape shall not cover on the feeding holes more than 0.75 mm

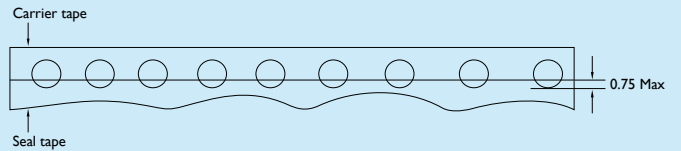
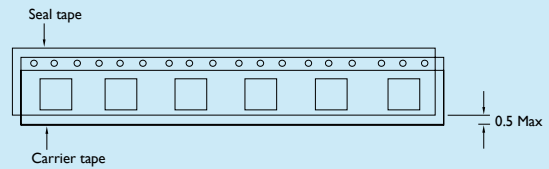

## ADHESION TEST

Reasonable pulling strength: 0.1~0.7N, Pulling speed: 300mm / min

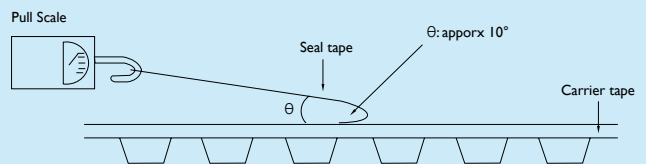



## PACKING STYLE

- (1) Carrier tape shall be reeled inside. (seal tape shall be outside)
- (2) End of the tape shall be inside to the reel physically as shown in the below figure and leader part of seal tape shall not be attached.

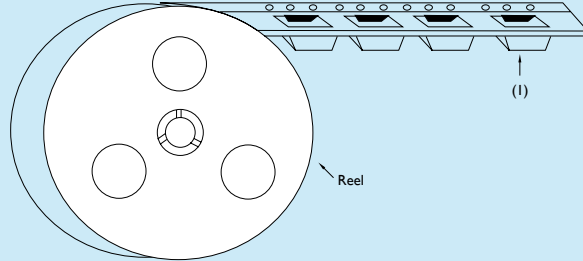

## PACKAGING QUANTITY

SIZE CODE	D x L	ONE REEL (PCS)	TOTAL QUANTITY (PCS)
B	4 x 5.4	2,000	20,000
C	5 x 5.4	1,000	10,000
D	6.3 x 5.4	1,000	10,000
E	8 x 6.5	1,000	10,000
F	8 x 10.5	500	4,000
G	10 x 10.5	500	4,000
H	6.3 x 7.7	1,000	10,000

# S5 [ For Super Miniature ]

105°C Single-Ended Lead, 5.0mm Height Type Aluminum Electrolytic Capacitors

## Miniature Aluminum Electrolytic Capacitors

### ELECTRICAL CHARACTERISTICS

Operating Temperature Range : -40 ~ +105°C

Rated Voltage Range : 4 ~ 50V

Rated Capacitance Range : 0.1 ~ 470μF

Capacitance Tolerance : -20 ~ +20% at 120Hz, 20°C

DC Leakage Current (μA) : I = 0.01CV (μA) or 3μA whichever is greater.  
(After Rated Voltage Applied for 2 Minutes )

Dissipation Factor : at 120 Hz, 20°C

WV (V) :	4	6.3	10	16	25	35	50
D.F (%) :	35	24	20	17	15	12	10

Endurance : After the rated voltage has been applied at 105°C for 1000 hours, the capacitors shall meet following requirements.

- (a) Capacitance Change : Within 20% of Initial Value
- (b) Dissipation Factor : 200% or Less of Initial Specified Value
- (c) Leakage Current : Initial Specified Value or Less

Shelf Life : After leaving capacitors under load at 105°C for 500 hours.

- (a) Capacitance Change : Within 20% of Initial Value
- (b) Dissipation Factor : 200% or Less of Initial Specified Value
- (c) Leakage Current : 200% or Less of Initial Specified Value

### DIAGRAM OF DIMENSIONS

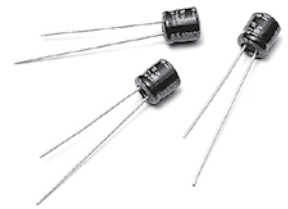
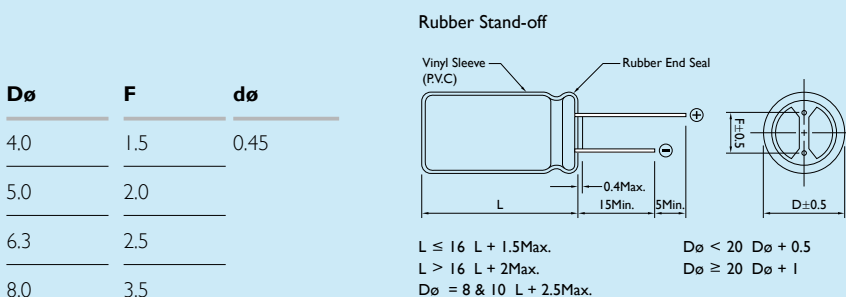

### DESCRIPTION

The S5 series is smaller than SS series.

This type is designed for saving space and high density insertion.

Applications : Camera, Car Audio, Miniaudio and Other Industrial and Commercial Applications

### MULTIPLIER FOR RIPPLE CURRENT

Frequency Coefficient

FREQUENCY (Hz)	120	300	1K	10K~100K
0.1~47μF	1.00	1.20	1.30	1.50
100~330μF	1.00	1.10	1.15	1.20

Temperature Coefficient

TEMPERATURE (°C)	65	85	105
FACTOR	1.40	1.20	1.00

Dimensions: mm

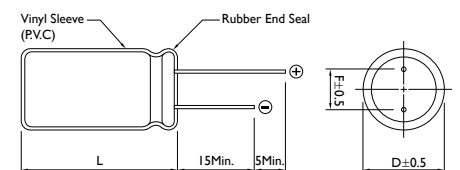



## CASE SIZE & PERMISSIBLE RIPPLE CURRENT OF STANDARD PRODUCTS

D x L: mm

CAP. (μF)	RATED VOLTAGE WV (SURGE VOLTAGE WV)													
	4 (5) SIZE		6.3 (8) SIZE		10 (13) SIZE		16 (20) SIZE		25 (32) SIZE		35 (44) SIZE		50 (63) SIZE	
	SIZE	SIZE	SIZE	SIZE	SIZE	SIZE	SIZE	SIZE	SIZE	SIZE	SIZE	SIZE	SIZE	SIZE
0.10													4 x 5	1
0.22													4 x 5	2
0.33													4 x 5	3
0.47													4 x 5	4
1.0													4 x 5	9
2.2													4 x 5	13
3.3													4 x 5	17
4.7							4 x 5	20	4 x 5	16	4 x 5	18	4 x 5	17
													5 x 5	20
10			4 x 5	18	4 x 5	20	4 x 5	23	4 x 5	20	5 x 5	30	6.3 x 5	33
15									5 x 5	27				
22	4 x 5	20	4 x 5	28	5 x 5	33	4 x 5	29	6.3 x 5	42	6.3 x 5	48	6.3 x 5	55
							5 x 5	37						
33	4 x 5	25	4 x 5	33	4 x 5	34	5 x 5	44	5 x 5	45				
					5 x 5	41	6.3 x 5	49	6.3 x 5	53				
47	5 x 5	30	4 x 5	35	5 x 5	46	5 x 5	54	5 x 5	55				
			5 x 5	45			6.3 x 5	58	6.3 x 5	65				
68					6.3 x 5	54								
100	6.3 x 5	50	5 x 5	55	6.3 x 5	80	6.3 x 5	85	8 x 5	90				
			6.3 x 5	70										
220	6.3 x 5	70	6.3 x 5	90										
330	8 x 5	110	8 x 5	115										
470			8 x 5	100										

Note: I. Ripple Current: (mA/rms) 105°C, 120Hz

# SS [ For Super Miniature ]

105°C Single-Ended Lead Aluminum Electrolytic Capacitors

## Miniature Aluminum Electrolytic Capacitors

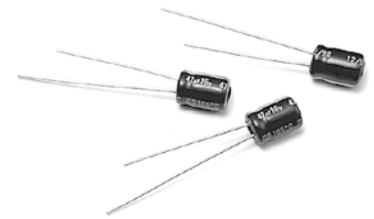

### DESCRIPTION

This type is designed to meet the demands of equipments with greatly reduced size and thickness, such as: portable micro computers, disk drivers, small calculators and audio equipment.

Applications : Portable Micro Computer; Disk Driver; Small Calculator and Audio

### MULTIPLIER FOR RIPPLE CURRENT

Frequency Coefficient

FREQUENCY (Hz)	50	120	300	1K	10K
0.1~47μF	0.75	1.00	1.20	1.30	1.50
100~330μF	0.75	1.00	1.10	1.15	1.20

Temperature Coefficient

TEMPERATURE (°C)	65	85	105
FACTOR	1.70	1.30	1.00

### ELECTRICAL CHARACTERISTICS

Operating Temperature Range : -40 ~ +105°C

Rated Voltage Range : 4 ~ 63V

Rated Capacitance Range : 0.1 ~ 470μF

Capacitance Tolerance : -20 ~ +20% at 120Hz, 20°C

DC Leakage Current (μA) : I = 0.01CV (μA) or 3μA whichever is greater.  
( After Rated Voltage Applied for 2 Minutes )

Dissipation Factor

WV (V) :	4	6.3	10	16	25	35	50	63
D.F. (%) :	35	24	20	17	15	12	10	8

Endurance : After the rated voltage has been applied at 105°C for 1000 hours

- (a) Capacitance Change : Within 20% of Initial Value
- (b) Dissipation Factor : 200% or Less of Initial Specified Value
- (c) Leakage Current : Initial Specified Value or Less

Shelf Life : After leaving capacitors under load at 105°C for 500 hours.

- (a) Capacitance Change : Within 20% of Initial Value
- (b) Dissipation Factor : 200% or Less of Initial Specified Value
- (c) Leakage Current : 200% or Less of Initial Specified Value

### DIAGRAM OF DIMENSIONS

Dimensions: mm

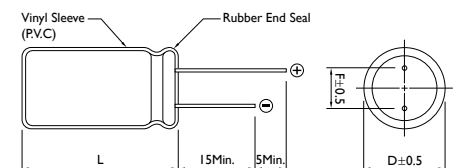
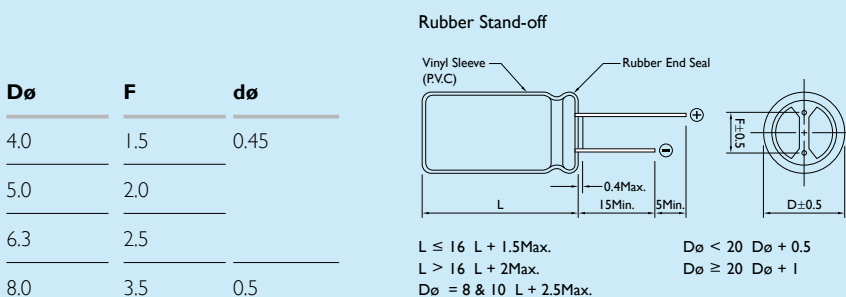



## CASE SIZE & PERMISSIBLE RIPPLE CURRENT OF STANDARD PRODUCTS

D x L: mm

CAP. (μF)	RATED VOLTAGE WV (SURGE VOLTAGE WV)															
	4 (5)		6.3 (8)		10 (13)		16 (20)		25 (32)		35 (44)		50 (63)		63 (79)	
	SIZE	RIPPLE	SIZE	RIPPLE	SIZE	RIPPLE	SIZE	RIPPLE	SIZE	RIPPLE	SIZE	RIPPLE	SIZE	RIPPLE	SIZE	RIPPLE
0.10													4 x 7	1	4 x 7	1
0.22													4 x 7	2	4 x 7	2
0.33													4 x 7	3	4 x 7	4
0.47													4 x 7	5	4 x 7	6
0.68													4 x 7	6		
1.0								4 x 7	10				4 x 7	10	4 x 7	13
2.2							4 x 7	7					4 x 7	19	4 x 7	21
3.3							4 x 7	13					4 x 7	24	4 x 7	26
4.7							4 x 7	19	4 x 7	24	4 x 7	24	4 x 7	29	4 x 7	26
										5 x 7	24	5 x 7	31	6.3 x 7	33	
10					4 x 7	22	4 x 7	29	4 x 7	33	4 x 7	34	4 x 7	37	5 x 7	42
									5 x 7	35	5 x 7	36	5 x 7	45	6.3 x 7	50
									6.3 x 7	35			6.3 x 7	45		
22			4 x 7	37	4 x 7	31	4 x 7	36	4 x 7	43	5 x 7	48	6.3 x 7	65		
					5 x 7	38	5 x 7	44	5 x 7	51	6.3 x 7	57				
									6.3 x 7	53						
33	4 x 7	30	5 x 7	42	4 x 7	39	4 x 7	50	5 x 7	55	6.3 x 7	70	6.3 x 7	80		
					5 x 7	47	5 x 7	57	6.3 x 7	65						
47	4 x 7	35	4 x 7	46	4 x 7	50	5 x 7	75	5 x 7	67	6.3 x 7	81				
			5 x 7	55	5 x 7	60	6.3 x 7	77	6.3 x 7	79						
					6.3 x 7	60										
68							5 x 7	84								
100	5 x 7	55	5 x 7	75	5 x 7	85	5 x 7	94	6.3 x 7	120						
			6.3 x 7	90	6.3 x 7	100	6.3 x 7	110	8 x 7	120						
150							6.3 x 7	120								
220	6.3 x 7	95	6.3 x 7	130	6.3 x 7	135	6.3 x 7	110								
							8 x 7	140								
							8 x 9	140								
330			8 x 7	140			8 x 9	155								
470			8 x 7	130												
			8 x 9	150	8 x 9	165	8 x 9	170								

Note: I, Ripple Current: (mA/rms) 105°C, 120Hz

# SK [ For General ]

85°C Single-Ended Lead Aluminum Electrolytic Capacitors

## Miniature Aluminum Electrolytic Capacitors

### ELECTRICAL CHARACTERISTICS

Operating Temperature Range : -40 ~ +85°C / -25 ~ +85°C

Rated Voltage Range : 6.3 ~ 100V / 160 ~ 450V

Rated Capacitance Range : 0.1 ~ 22000μF / 0.47 ~ 470μF

Capacitance Tolerance : -20 ~ +20% at 120Hz, 20°C

DC Leakage Current (μA) : I = 0.01CV (μA) or 3μA / I = 0.03CV (μA) + 10μA whichever is greater.  
(After Rated Voltage Applied for 2 Minutes )

Dissipation Factor

WV (V):	6.3	10	16	25	35	50	63	100	160 ~ 250	350 ~ 450
D.F (%) :	24	20	16	14	12	10	10	10	20	24

For capacitors whose capacitance exceeds 1000μF. The value of DF(%) is increased by 2% for every addition of 1000μF.

Endurance : After the rated voltage has been applied at 85°C for 2000 hours, the capacitors shall meet following requirements.

- (a) Capacitance Change : Within 20% of Initial Value
- (b) Dissipation Factor : 200% or Less of Initial Specified Value
- (c) Leakage Current : Initial Specified Value or Less

Shelf Life : After have been placed at 85°C without voltage applied for 1000 hours the capacitors shall meet following requirements.

- (a) Capacitance Change : Within 20% of Initial Value
- (b) Dissipation Factor : 200% or Less of Initial Specified Value
- (c) Leakage Current : Initial Specified Value or Less

### DIAGRAM OF DIMENSIONS

Dø	F	dø
4.0	1.5	0.45
5.0	2.0	0.5
6.3	2.5	
8.0	3.5	0.6
10.0	5.0	
12.0		
13.0		
16.0	7.5	0.8
18.0		
22.0	10.0	

Rubber Stand-off

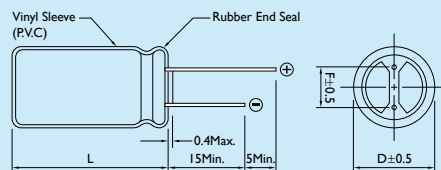

$L \leq 16$   $L + 1.5$ Max.  
 $L > 16$   $L + 2$ Max.  
 $D\phi = 8 \ \& \ 10$   $L + 2.5$ Max.  
 $D\phi < 20$   $D\phi + 0.5$   
 $D\phi \geq 20$   $D\phi + 1$



### DESCRIPTION

Lower-cost capacitors suitable for high density printed circuit boards.

Very high volumetric efficiency

Ideally suited for general purpose applications, decoupling bypass, and filtering circuit in entertainment electronics.

Featuring high CV products with moderate cost

### MULTIPLIER FOR RIPPLE CURRENT

Frequency Coefficient

FREQUENCY (Hz)	120	300	1K	10K-100K
6.3~100V Below~68μF	1.00	1.20	1.30	1.50
6.3~100V 100~680μF	1.00	1.10	1.15	1.20
6.3~110V 1000~22000μF	1.00	1.05	1.10	1.15
160~450V Below~220μF	1.00	1.25	1.40	1.40
160~450V 220μF Above	1.00	1.10	1.13	1.13

Temperature Coefficient

TEMPERATURE (°C)	50	70	85
FACTOR	1.30	1.15	1.00

Dimensions: mm



## CASE SIZE & PERMISSIBLE RIPPLE CURRENT OF STANDARD PRODUCTS

D × L: mm

CAP. (μF)	RATED VOLTAGE WV (SURGE VOLTAGE WV)													
	6.3 (8) SIZE		10 (13) SIZE		16 (20) SIZE		25 (32) SIZE		35 (44) SIZE		50 (63) SIZE		63 (79) SIZE	
	SIZE	RIPPLE	SIZE	RIPPLE	SIZE	RIPPLE	SIZE	RIPPLE	SIZE	RIPPLE	SIZE	RIPPLE	SIZE	RIPPLE
0.10											5 × 11	1		
0.22											5 × 11	2		
0.33											5 × 11	3	5 × 11	3
0.47											5 × 11	5	5 × 11	5
0.68											5 × 11	7		
1.0			5 × 11	10	5 × 11	10					5 × 11	10	5 × 11	10
2.2			5 × 11	20							5 × 11	23	5 × 11	29
3.3											5 × 11	35	5 × 11	40
4.7			5 × 11	20	5 × 11	25	5 × 11	30	5 × 11	35	5 × 11	40	5 × 11	45
6.8											5 × 11	50		
10			5 × 11	35	5 × 11	40	5 × 11	50	5 × 11	60	5 × 11	65	5 × 11	70
15					5 × 11	50					5 × 11	80		
22	5 × 11	35	5 × 11	55	5 × 11	75	5 × 11	90	5 × 11	95	5 × 11	100	5 × 11	95
													6.3 × 11	115
33	5 × 11	55	5 × 11	80	5 × 11	110	5 × 11	115	5 × 11	120	5 × 11	105	6.3 × 11	130
											6.3 × 11	125	8 × 11	140
47	5 × 11	75	5 × 11	95	5 × 11	130	5 × 11	135	5 × 11	120	6.3 × 11	140	6.3 × 11	160
							6.3 × 11	135	6.3 × 11	140	8 × 11	150	8 × 11	190
68					5 × 11	150	6.3 × 11	145	8 × 11	180				
100	5 × 11	130	5 × 11	180	5 × 11	165	6.3 × 11	160	6.3 × 11	185	8 × 11	230	10 × 12	300
					6.3 × 11	185	8 × 11	200	8 × 11	230	10 × 12	250	10 × 15	300
150					6.3 × 11	205								
220	5 × 11	200	5 × 11	215	6.3 × 11	260	8 × 11	290	8 × 11	290	10 × 12	380	10 × 15	410
	6.3 × 11	240	6.3 × 11	250	8 × 11	320	10 × 12	340	10 × 12	370	10 × 15	440	10 × 19.5	490
									10 × 15	370				
330	6.3 × 11	260	6.3 × 11	265	6.3 × 11	290	8 × 11	315	8 × 15	386	10 × 15	490	10 × 19.5	540
	8 × 11	300	8 × 11	330	8 × 11	360	8 × 15	380	10 × 12	420	10 × 19.5	580	13 × 20	680
							10 × 12	420	10 × 15	490	13 × 13	530		
470	6.3 × 11	330	6.3 × 11	320	8 × 11	400	8 × 15	420	10 × 15	430	10 × 19.5	610	13 × 20	755
	8 × 11	380	8 × 11	400	10 × 12	470	10 × 12	460	10 × 19.5	510	13 × 20	760	13 × 25	880
							10 × 15	540	13 × 20	640			16 × 25	880

Note: I<sub>r</sub> Ripple Current: (mA/rms) 85°C, 120Hz



## CASE SIZE & PERMISSIBLE RIPPLE CURRENT OF STANDARD PRODUCTS

D x L: mm

CAP. (μF)	RATED VOLTAGE WV (SURGE VOLTAGE WV)															
	6.3 (8)		10 (13)		16 (20)		25 (32)		35 (44)		50 (63)		63 (79)			
	SIZE	RIPPLE	SIZE	RIPPLE	SIZE	RIPPLE	SIZE	RIPPLE	SIZE	RIPPLE	SIZE	RIPPLE	SIZE	RIPPLE		
680	8 x 11	410	10 x 12	460	10 x 12	510	10 x 15	540	13 x 20	705			13 x 25	965		
					10 x 15	565	10 x 19.5	595	13 x 25	780			16 x 25	1085		
1000	8 x 11	460	10 x 12	580	10 x 12	530	10 x 19.5	760	10 x 19.5	770	13 x 25	1100	16 x 25	1310		
					10 x 15	630	10 x 15	630	12 x 16	760	13 x 20	950	16 x 25	1350	16 x 32	1550
					10 x 19.5	790	13 x 16	760	13 x 25	1100						
							13 x 20	950								
1200	10 x 12	620	10 x 15	754												
1500			10 x 19.5	700	13 x 16	825			16 x 25	1240						
2200	10 x 19.5	840	10 x 19.5	880	10 x 19.5	925	13 x 20	1100	16 x 25	1600	16 x 36	1850	18 x 40	2200		
	13 x 20	1050	13 x 20	1100	13 x 20	1100	13 x 25	1300	16 x 32	1800	18 x 36	2090	22 x 35	2200		
					13 x 25	1350	16 x 25	1550					22 x 40	2200		
							18 x 20	1550								
3300	10 x 19.5	1000	13 x 20	1250	13 x 20	1200	16 x 25	1660	16 x 36	1970	18 x 36	2170	22 x 40	2500		
	13 x 20	1250	13 x 25	1400	13 x 25	1400	16 x 32	1950	18 x 36	2220	18 x 40	2400				
					16 x 25	1700										
4700	13 x 20	1300	13 x 25	1500	13 x 40	1882	16 x 32	1950	16 x 36	2136	18 x 50	2350				
	13 x 25	1437	16 x 25	1800	16 x 25	1800	18 x 36	2360	18 x 36	2400	22 x 35	2240				
	16 x 25	1700			16 x 32	2100					22 x 40	2500				
6800	16 x 25	1900	16 x 25	1900	16 x 32	1980	18 x 36	2550	18 x 40	2200						
			16 x 32	2150	16 x 36	2200			22 x 40	2600						
					18 x 36	2500										
10000	16 x 25	1900	16 x 36	2225	18 x 36	2700	22 x 40	2800								
	16 x 32	2250	18 x 36	2500												
15000	16 x 36	2500	18 x 36	2950	22 x 40	3150	22 x 40	3200								
	18 x 36	2880														
22000	18 x 40	3650	22 x 40	3700	22 x 40	3800										

Note: I. Ripple Current: (mA/rms) 85°C, 120Hz



## CASE SIZE & PERMISSIBLE RIPPLE CURRENT OF STANDARD PRODUCTS

D x L: mm

CAP. (μF)	RATED VOLTAGE WV (SURGE VOLTAGE WV)													
	100 (125)		160 (200)		200 (250)		250 (300)		350 (400)		400 (450)		450 (500)	
	SIZE	RIPPLE	SIZE	RIPPLE	SIZE	RIPPLE	SIZE	RIPPLE	SIZE	RIPPLE	SIZE	RIPPLE	SIZE	RIPPLE
0.22	5 x 11	5												
0.47	5 x 11	10	5 x 11	12	5 x 11	14	5 x 11	14	5 x 11	14	6.3 x 11	14	6.3 x 11	14
1.0	5 x 11	21	5 x 11	17	5 x 11	19	5 x 11	17	6.3 x 11	19	6.3 x 11	16	6.3 x 11	15
			6.3 x 11	17			6.3 x 11	19			8 x 11	19	8 x 11	19
2.2	5 x 11	30	6.3 x 11	26	6.3 x 11	22	6.3 x 11	24	8 x 11	33	8 x 11	26	10 x 12	33
					8 x 11	27	8 x 11	30	10 x 12	33	10 x 12	33		
3.3	5 x 11	45	6.3 x 11	30	6.3 x 11	30	8 x 11	30	8 x 11	33	10 x 12	40	10 x 15	42
			8 x 11	35	8 x 11	37	10 x 12	38	10 x 12	39				
4.7	5 x 11	50	6.3 x 11	32	8 x 11	36	8 x 11	36	8 x 11	36	10 x 15	45	10 x 15	50
			8 x 11	40	10 x 12	45	10 x 12	45	10 x 12	39			10 x 19.5	50
									10 x 15	45				
6.8	5 x 11	55					8 x 11	40					10 x 15	50
							10 x 12	50					10 x 19.5	50
10	5 x 11	65	8 x 11	50	10 x 12	57	10 x 15	70	10 x 15	70	10 x 15	50	13 x 20	60
			6.3 x 11	75	10 x 12	65	10 x 15	70	10 x 19.5	70	13 x 20	70	10 x 19.5	56
					10 x 15	65					13 x 20	70		
15	8 x 11	93					10 x 19.5	75	10 x 19.5	90			13 x 20	93
							13 x 20	90						
22	6.3 x 11	105	10 x 15	110	10 x 15	120	10 x 19.5	130	13 x 20	130	13 x 20	100	16 x 20	100
	8 x 11	130	10 x 19.5	110							13 x 25	110	16 x 25	110
											16 x 25	130	16 x 32	130
33	8 x 11	140	10 x 19.5	150	10 x 19.5	160	13 x 20	140	13 x 25	170	13 x 25	140	16 x 25	145
	10 x 12	170					13 x 25	160	16 x 25	170	16 x 20	145	16 x 32	160
											16 x 25	170	16 x 36	180
47	10 x 12	190	12 x 16	145	13 x 20	160	13 x 20	180	16 x 25	220	16 x 25	180	18 x 36	200
	10 x 15	230	12 x 25	180	13 x 25	190	13 x 25	210			16 x 32	220	18 x 40	230
			13 x 20	180			16 x 25	210			16 x 36	220		
68	10 x 15	280			13 x 25	230					18 x 25	236	18 x 32	265
100	10 x 19.5	400	13 x 25	250	16 x 25	330	16 x 32	310	16 x 36	320	16 x 36	320	22 x 40	370
			16 x 25	300					18 x 36	360	18 x 36	360		

Note: I. Ripple Current: (mA/rms) 85°C, 120Hz

## CASE SIZE & PERMISSIBLE RIPPLE CURRENT OF STANDARD PRODUCTS

D x L: mm

CAP. (μF)	RATED VOLTAGE WV (SURGE VOLTAGE WV)													
	100 (125)		160 (200)		200 (250)		250 (300)		350 (400)		400 (450)		450 (500)	
	SIZE	RIPPLE	SIZE	RIPPLE	SIZE	RIPPLE	SIZE	RIPPLE	SIZE	RIPPLE	SIZE	RIPPLE	SIZE	RIPPLE
150	13 x 20	500					18 x 40	410						
220	13 x 25	710	16 x 32	450	18 x 25	485	18 x 36	540			18 x 40	800		
			16 x 36	510	18 x 32	540	18 x 40	600						
					18 x 36	600								
330	13 x 25	720	18 x 36	540	16 x 40	710								
			16 x 25	860	18 x 40	600	16 x 45	750						
					18 x 32	685								
					18 x 36	725								
					18 x 40	800								
470	13 x 40	1100	22 x 40	900	18 x 40	750								
	16 x 25	1100			22 x 35	1000								
	16 x 32	1100												
680	16 x 36	1260												
1000	18 x 40	1350												
	22 x 35	1680												
2200	22 x 40	2300												

Note: I. Ripple Current: (mA/rms) 85°C, 120Hz

# Miniature Aluminum Electrolytic Capacitors

# SE-K [ For General ]

105°C Single-Ended Lead Aluminum Electrolytic Capacitors Rated Voltage up to 450V



## DESCRIPTION

Lower-cost capacitors suitable for high density printed circuit boards.

Very high volumetric efficiency

Ideally suited for general purpose applications, coupling, decoupling, bypass, and filtering circuit in entertainment electronics.

Featuring high CV products with moderate cost

### MULTIPLIER FOR RIPPLE CURRENT

Frequency Coefficient

FREQUENCY (Hz)	120	300	1K	10K~100K
6.3~100V Below~68μF	1.00	1.20	1.30	1.45
6.3~100V 100~680μF	1.00	1.10	1.15	1.25
6.3~110V 1000~22000μF	1.00	1.05	1.10	1.15
160~450V ALL Cap(μF)	1.00	1.05	1.10	1.50

## ELECTRICAL CHARACTERISTICS

Operating Temperature Range : -40 ~ +105°C / -40 ~ +105°C / 25 ~ +105°C

Rated Voltage Range : 6.3 ~ 100V / 160 ~ 250V / 350 ~ 450V

Rated Capacitance Range : 0.47 ~ 15000μF / 0.47 ~ 470μF / 0.47 ~ 150μF

Capacitance Tolerance : -20 ~ +20% at 120Hz, 20°C

Leakage Current (μA) :  $I = 0.01CV (\mu A) + 3\mu A / 0.03CV (\mu A) + 10\mu A$  whichever is greater.  
(After Rated Voltage Applied for 2 Minutes)

Dissipation Factor

WV (V) :	6.3	10	16	25	35	50	63~100	160 ~ 250	350 ~ 450
D.F. (%) :	26	22	18	16	14	12	10	15	20

Endurance : After the rated voltage has been applied at 105°C for 1000 hours. The capacitors shall meet the following requirements.

- (a) Capacitance Change : Within 20% of Initial Value
- (b) Dissipation Factor : 200% or Less of Initial Specified Value
- (c) Leakage Current : Initial Specified Value or Less

Shelf Life : After leaving capacitors under no load at 105°C for 500 hours, the capacitors shall meet the same requirements as Endurance.

## DIAGRAM OF DIMENSIONS

Dimensions: mm

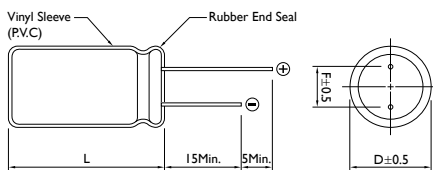

Rubber Stand-off

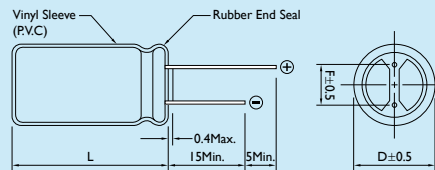

$L \leq 16 L + 1.5\text{Max.}$

$I > 16 L + 2\text{Max.}$

$D\phi = 8 \ \& \ 10 L + 2.5\text{Max.}$

$D\phi < 20 D\phi + 0.5$

$D\phi \geq 20 D\phi + 1$

D $\phi$	F	d $\phi$
5.0	2.0	0.5
6.3	2.5	
8.0	3.5	0.6
10.0	5.0	
12.0		
13.0		
16.0	7.5	0.8
18.0		
22.0	10.0	0.8 (1.0)

## CASE SIZE & PERMISSIBLE RIPPLE CURRENT OF STANDARD PRODUCTS

D x L: mm

CAP. (μF)	RATED VOLTAGE WV (SURGE VOLTAGE WV)														
	6.3 (8)		10 (13)		16 (20)		25 (32)		35 (44)		50 (63)		63 (79)		
	SIZE	RIPPLE	SIZE	RIPPLE	SIZE	RIPPLE	SIZE	RIPPLE	SIZE	RIPPLE	SIZE	RIPPLE	SIZE	RIPPLE	
0.47											5 x 11	7	5 x 11	8	
0.68											5 x 11	7			
1.0											5 x 11	12	5 x 11	13	
2.2											5 x 11	18	5 x 11	20	
3.3											5 x 11	25	5 x 11	27	
4.7							5 x 11	20	5 x 11	25	5 x 11	30	5 x 11	34	
6.8							5 x 11	25	5 x 11	30	5 x 11	32	5 x 11	37	
10					5 x 11	25	5 x 11	30	5 x 11	40	5 x 11	50	5 x 11	55	
15					5 x 11	40	5 x 11	45	5 x 11	50	5 x 11	60	5 x 11	65	
22			5 x 11	45	5 x 11	55	5 x 11	60	5 x 11	65	5 x 11	75	5 x 11	75	
													6.3 x 11	90	
33			5 x 11	60	5 x 11	70	5 x 11	75	5 x 11	85	6.3 x 11	105	6.3 x 11	110	
													8 x 11	120	
47	5 x 11	60	5 x 11	75	5 x 11	85	5 x 11	90	5 x 11	95	6.3 x 11	105	6.3 x 11	128	
						6.3 x 11	97			6.3 x 11	115	8 x 11	125	8 x 11	155
68	5 x 11	75	5 x 11	80	5 x 11	100	6.3 x 11	125	8 x 11	130	8 x 11	159	10 x 12	198	
100	5 x 11	100	5 x 11	110	5 x 11	110	6.3 x 11	145	6.3 x 11	150	8 x 11	160	8 x 15	230	
			6.3 x 11	135	6.3 x 11	135	8 x 11	160	8 x 11	190	10 x 12	210	10 x 12	260	
150	5 x 11	120	5 x 11	110	8 x 11	180	8 x 11	200	10 x 12	240	10 x 12	289	10 x 15	330	
			6.3 x 11	130											
220	5 x 11	140	5 x 11	150	6.3 x 11	180	8 x 11	200	8 x 11	230	10 x 12	340	10 x 15	400	
	6.3 x 11	165	6.3 x 11	180	8 x 11	235	10 x 12	250	8 x 15	280	10 x 15	400	10 x 19.5	460	
									10 x 12	315					
270			8 x 11	210											
330	6.3 x 11	160	6.3 x 11	205	8 x 11	285	8 x 11	265	8 x 15	345	10 x 15	450	10 x 19.5	520	
	8 x 11	200	8 x 11	255			8 x 15	320	8 x 20	420	10 x 19.5	535	13 x 20	650	
							10 x 12	355	10 x 12	380					
									10 x 15	440					
470	6.3 x 11	220	6.3 x 11	245	8 x 11	310	8 x 15	365	10 x 15	415	10 x 19.5	580	13 x 20	700	
	8 x 11	280	8 x 11	305	8 x 15	360	10 x 12	400	10 x 19.5	490	13 x 20	730	13 x 25	800	
					10 x 12	395	10 x 15	470	13 x 20	580					
560									10 x 30	600					

Note: I. Ripple Current: (mA/rms) 105°C, 120Hz



## CASE SIZE & PERMISSIBLE RIPPLE CURRENT OF STANDARD PRODUCTS

D x L: mm

CAP. (μF)	RATED VOLTAGE WV (SURGE VOLTAGE WV)													
	6.3 (8) SIZE    RIPPLE		10 (13) SIZE    RIPPLE		16 (20) SIZE    RIPPLE		25 (32) SIZE    RIPPLE		35 (44) SIZE    RIPPLE		50 (63) SIZE    RIPPLE		63 (79) SIZE    RIPPLE	
680	8 x 11	255	8 x 11	335	10 x 12	455	10 x 15	540	10 x 19.5	600	13 x 25	860	13 x 25	840
	10 x 12	320	8 x 15	385	10 x 15	530	10 x 19.5	650	13 x 20	730			16 x 25	1000
			10 x 12	420										
1000	8 x 11	370	8 x 11	390	8 x 20	600	10 x 19.5	680	13 x 20	850	13 x 25	930	16 x 25	1020
	10 x 12	470	8 x 15	450	10 x 15	590	13 x 20	855	13 x 25	995	16 x 25	1110	16 x 32	1200
			10 x 12	490	10 x 19.5	700								
			10 x 15	570										
1500	10 x 15	600	10 x 19.5	750	10 x 19.5	680	13 x 25	1020	13 x 25	935	16 x 32	1350	16 x 32	1300
							13 x 20	860	16 x 25	1110			16 x 36	1450
2200	10 x 19.5	740	10 x 19.5	800	10 x 25	895	13 x 25	1030	16 x 25	1230	16 x 36	1360	18 x 36	1455
	13 x 20	930	13 x 20	1010	12 x 25	1040	16 x 25	1230	16 x 32	1450	18 x 36	1530		
					13 x 20	990								
					13 x 25	1150								
3300	10 x 19.5	880	10 x 25	950	13 x 25	1140	13 x 25	1035	16 x 36	1470	18 x 36	1540		
	13 x 20	1100	10 x 30	1090	16 x 25	1350	16 x 25	1230	18 x 36	1660	18 x 40	1700		
			13 x 20	1050			16 x 32	1450						
			13 x 25	1220										
4700	13 x 25	1100	13 x 25	1190	16 x 25	1330	16 x 32	1420	18 x 36	1580	22 x 35	1900		
	16 x 25	1320	16 x 25	1410	16 x 32	1560	18 x 36	1690	18 x 40	1750				
6800	13 x 25	1250	16 x 25	1370	16 x 32	1400	18 x 36	1850	18 x 40	1600				
	16 x 25	1490	16 x 32	1610	16 x 36	1590			22 x 40	1885				
					16 x 40	1670								
					18 x 32	1600								
					18 x 36	1790								
10000	16 x 25	1560	16 x 36	1760	18 x 36	2100								
	16 x 32	1830	18 x 36	1980										
15000	18 x 36	2280	18 x 40	1960										

Note: I. Ripple Current: (mA/rms) 105°C, 120Hz

## CASE SIZE & PERMISSIBLE RIPPLE CURRENT OF STANDARD PRODUCTS

D x L: mm

CAP. (μF)	RATED VOLTAGE WV (SURGE VOLTAGE WV)													
	100 (125)		160 (200)		200 (250)		250 (300)		350 (400)		400 (450)		450 (500)	
	SIZE	RIPPLE	SIZE	RIPPLE	SIZE	RIPPLE	SIZE	RIPPLE	SIZE	RIPPLE	SIZE	RIPPLE	SIZE	RIPPLE
0.47	5 x 11	10	5 x 11	12	5 x 11	14	5 x 11	14	5 x 11	14	6.3 x 11	14	6.3 x 11	14
1.0	5 x 11	15	5 x 11	17	5 x 11	19	6.3 x 11	19	6.3 x 11	20	6.3 x 11	16	8 x 11	20
											8 x 11	20		
2.2	5 x 11	22	6.3 x 11	25	6.3 x 11	22	6.3 x 11	23	8 x 11	35	8 x 11	28	10 x 12	35
					8 x 11	28	8 x 11	29			10 x 12	35		
3.3	5 x 11	29	6.3 x 11	30	6.3 x 11	32	8 x 11	33	8 x 11	37	8 x 11	38	10 x 15	54
			8 x 11	36	8 x 11	40	10 x 12	42	10 x 12	47	10 x 12	50		
4.7	5 x 11	37	6.3 x 11	34	8 x 11	40	8 x 11	41	8 x 11	37	8 x 11	40	10 x 15	60
			8 x 11	43	10 x 12	50	10 x 12	52	10 x 12	47	8 x 15	45		
									10 x 15	55	10 x 12	49		
											10 x 15	57		
6.8	5 x 11	46	10 x 12	54	10 x 12	60	8 x 15	57	10 x 15	65	10 x 15	60	10 x 19.5	70
							10 x 12	62			10 x 19.5	72		
10	5 x 11	55	8 x 11	56	10 x 12	69	10 x 15	88	10 x 15	95	10 x 15	65	10 x 19.5	75
	6.3 x 11	65	10 x 12	70	10 x 15	80	10 x 19.5	90			10 x 19.5	77	13 x 20	85
											13 x 20	97	13 x 25	100
15	8 x 11	82	10 x 15	90	10 x 15	110	10 x 15	120	10 x 19.5	140	10 x 19.5	100	16 x 25	160
											13 x 20	125		
											13 x 25	150		
22	8 x 11	115	8 x 20	125	10 x 15	140	10 x 19.5	155	13 x 20	165	13 x 20	150	13 x 25	125
			10 x 15	130							13 x 25	175	16 x 25	150
													16 x 32	180
33	8 x 11	120	10 x 19.5	180	10 x 19.5	190	13 x 20	170	13 x 25	220	13 x 25	190	16 x 25	190
	10 x 12	160					13 x 25	200			16 x 20	195	16 x 36	240
											16 x 25	230		
47	10 x 12	180	13 x 20	270	13 x 20	240	13 x 25	330	16 x 25	340	16 x 25	280	16 x 36	300
	10 x 15	210			13 x 25	290					16 x 32	315	18 x 40	360
											16 x 36	350		
											18 x 20	275		
											18 x 25	300		

Note: I. Ripple Current: (mA/rms) 105°C, 120Hz



## CASE SIZE & PERMISSIBLE RIPPLE CURRENT OF STANDARD PRODUCTS

D x L: mm

CAP. (μF)	RATED VOLTAGE WV (SURGE VOLTAGE WV)													
	100 (125)		160 (200)		200 (250)		250 (300)		350 (400)		400 (450)		450 (500)	
	SIZE	RIPPLE	SIZE	RIPPLE	SIZE	RIPPLE	SIZE	RIPPLE	SIZE	RIPPLE	SIZE	RIPPLE	SIZE	RIPPLE
68	10 x 15	241	13 x 25	300	13 x 25	330	16 x 25	350	16 x 32	370	16 x 32	320	18 x 32	305
											16 x 36	335	22 x 40	400
											18 x 25	305		
												18 x 36	380	
100	10 x 19.5	385	13 x 25	330	13 x 25	340	16 x 32	430	18 x 36	460	16 x 36	425	18 x 36	380
			16 x 25	400	16 x 25	410			18 x 32	430	18 x 40	400		
									18 x 36	480	22 x 40	450		
120										18 x 36	480			
150	13 x 25	414	16 x 32	435	16 x 32	400	18 x 40	460	22 x 40	480	22 x 40	450		
					16 x 36	450								
180											18 x 40	350		
220	13 x 25	590	16 x 32	550	18 x 32	520	22 x 40	680						
			16 x 36	620	18 x 36	580								
					18 x 40	650								
330	13 x 25	600	18 x 36	770	18 x 36	705								
	16 x 25	720	18 x 40	850	18 x 40	780								
					22 x 40	920								
470	16 x 25	740	22 x 40	980										
	16 x 32	875												
680	16 x 36	1200												
1000	18 x 40	1340												
	22 x 40	1500												

Note: I. Ripple Current: (mA/rms) 105°C, 120Hz



# Miniature Aluminum Electrolytic Capacitors

# SH [ For General ]

105°C Single-Ended Lead Aluminum Electrolytic Capacitors  
for the Rated Voltage up to 450V

## ELECTRICAL CHARACTERISTICS

Operating Temperature Range : -40 ~ +105°C / -25 ~ +105°C

Rated Voltage Range : 6.3 ~ 100V / 160 ~ 450V

Rated Capacitance Range : 0.47 ~ 15000μF / 0.47 ~ 470μF

Capacitance Tolerance : -20 ~ +20% at 120Hz, 20°C

Leakage Current (μA) :  $I = 0.01CV (\mu A) + 3\mu A / 0.03CV (\mu A) + 10\mu A$   
(After Rated Voltage Applied for 2 Minutes )

Dissipation Factor

WV (V) :	6.3	10	16	25	35	50	63 ~ 100	160 ~ 250	350 ~ 450
D.F (%) :	26	22	18	16	14	12	10	15	20

For capacitors whose capacitance exceeds 1000μF. The value of DF(%) is increased by 2% for every addition of 1000μF.

Low Temperature Stability Impedance Ratio (Max.)

WV (V) :		6.3	10	16	25 ~ 100	160 ~ 250	350 ~ 450
Impedance :	Z - 25°C / Z + 25°C	4	3	2	2	4	4
	Z - 40°C / Z + 20°C	8	6	4	3	-	-

Endurance : After the rated voltage has been applied at 105°C for 2000 hours, the capacitors shall meet following requirements.

- (a) Capacitance Change : Within 20% of Initial Value
- (b) Dissipation Factor : 200% or Less of Initial Specified Value
- (c) Leakage Current : Initial Specified Value or Less

Shelf Life: After leaving capacitors under no load at 105°C for 1000 hours, the capacitors shall meet the same requirements as Endurance.

## DIAGRAM OF DIMENSIONS

Dø	F	dø
5.0	2.0	0.5
6.3	2.5	
8.0	3.5	0.6
10.0	5.0	
12.0		
13.0		
16.0	7.5	0.8
18.0		
22.0	10.0	

Rubber Stand-off

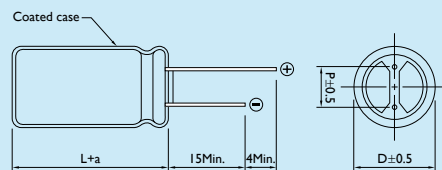

$L \leq 16$   $L + 1.5Max.$   $D\phi < 20$   $D\phi + 0.5$   
 $L > 16$   $L + 2Max.$   $D\phi \geq 20$   $D\phi + 1$   
 $D\phi = 8 \ \& \ 10$   $L + 2.5Max.$

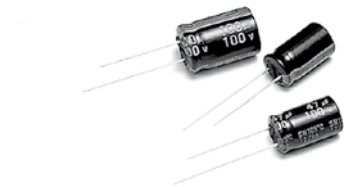

## DESCRIPTION

Long life for 2000 hours at 105°C, ideally suited for high quality and high reliability applications.

Featuring high CV products

### MULTIPLIER FOR RIPPLE CURRENT

Frequency Coefficient

FREQUENCY (Hz)	120	300	1K	10K~100K
6.3~100V Below~68μF	1.00	1.30	1.57	2.00
6.3~100V 100~470μF	1.00	1.23	1.34	1.50
6.3~100V 471~22000μF	1.00	1.10	1.13	1.15
160~450V ALL Cap(μF)	1.00	1.25	1.40	1.60

Temperature Coefficient

TEMPERATURE (°C)	65	85	105
FACTOR	1.70	1.40	1.00

Dimensions: mm

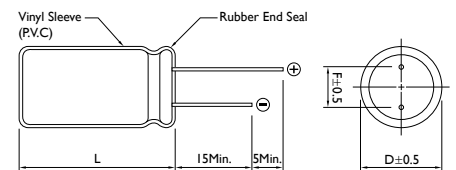



## CASE SIZE & PERMISSIBLE RIPPLE CURRENT OF STANDARD PRODUCTS

D x L: mm

CAP. (μF)	RATED VOLTAGE WV (SURGE VOLTAGE WV)									
	6.3 (8) SIZE		10 (13) SIZE		16 (20) SIZE		25 (32) SIZE		35 (44) SIZE	
		RIPPLE		RIPPLE		RIPPLE		RIPPLE		RIPPLE
10					5 x 11	44	5 x 11	43	5 x 11	44
15									5 x 11	50
22							5 x 11	60	5 x 11	65
33					5 x 11	70	5 x 11	75	5 x 11	85
47			5 x 11	75	5 x 11	85	5 x 11	90	6.3 x 11	115
68			5 x 11	80	5 x 11	100	6.3 x 11	125	8 x 11	130
100	5 x 11	100	5 x 11	110	5 x 11	115	6.3 x 11	145	6.3 x 11	150
					6.3 x 11	135			8 x 11	190
150	5 x 11	120	6.3 x 11	130	8 x 11	180	8 x 11	200	10 x 12	240
220	6.3 x 11	165	6.3 x 11	180	6.3 x 11	180	8 x 11	200	10 x 12	315
					8 x 11	235	10 x 12	250		
330	6.3 x 11	161	8 x 11	255	8 x 11	315	10 x 12	355	10 x 12	380
	8 x 11	200			10 x 12	285			10 x 15	440
470	6.3 x 11	225	8 x 11	305	8 x 11	315	10 x 15	470	10 x 15	440
	8 x 11	280			10 x 12	395			10 x 19.5	460
									13 x 20	580
680	10 x 12	320	10 x 12	420	10 x 15	530	10 x 19.5	650	13 x 20	730
1000	10 x 12	470	10 x 12	490	10 x 19.5	700	13 x 20	855	13 x 25	995
			10 x 15	570						
1500	10 x 15	600	10 x 19.5	750	10 x 19.5	705	13 x 25	1020	16 x 25	1110
					13 x 20	860				
2200	13 x 20	930	10 x 19.5	800	13 x 20	991	16 x 25	1230	16 x 25	1236
			13 x 20	1010	13 x 25	1150			16 x 32	1450
3300	13 x 20	1100	13 x 25	1220	13 x 25	1150	16 x 32	1450	16 x 36	1477
					16 x 25	1350			18 x 36	1660
4700	16 x 25	1320	16 x 25	1410	16 x 25	1330	18 x 36	1690		
					16 x 32	1560				
6800	16 x 25	1490	16 x 32	1610	18 x 36	1790				
10000	16 x 32	1830	18 x 36	1980						
15000	18 x 36	2280								

Note: I. Ripple Current: (mA/rms) 105°C, 120Hz

## CASE SIZE & PERMISSIBLE RIPPLE CURRENT OF STANDARD PRODUCTS

D x L: mm

CAP. (μF)	RATED VOLTAGE WV (SURGE VOLTAGE WV)									
	50 (63)		63 (79)		100 (125)		160 (200)		200 (250)	
	SIZE	RIPPLE	SIZE	RIPPLE	SIZE	RIPPLE	SIZE	RIPPLE	SIZE	RIPPLE
0.47	5 x 11	7	5 x 11	8	5 x 11	10	5 x 11	12	5 x 11	12
1.0	5 x 11	12	5 x 11	12	5 x 11	15	5 x 11	17	6.3 x 11	17
2.2	5 x 11	18	5 x 11	20	5 x 11	22	6.3 x 11	25	6.3 x 11	25
3.3	5 x 11	25	5 x 11	27	5 x 11	29	8 x 11	36	8 x 11	36
4.7	5 x 11	30	5 x 11	34	5 x 11	37	6.3 x 11	34	10 x 12	50
							8 x 11	43		
6.8	5 x 11	30	5 x 11	37	5 x 11	46	10 x 12	54	10 x 12	60
10	5 x 11	50	5 x 11	55	6.3 x 11	65	10 x 12	70	10 x 12	69
									10 x 15	80
15	5 x 11	50	5 x 11	65	8 x 11	82	10 x 15	90	10 x 19.5	110
22	5 x 11	75	6.3 x 11	90	8 x 11	115	10 x 19.5	130	10 x 15	140
									10 x 19.5	150
33	6.3 x 11	105	8 x 11	110	10 x 12	160	13 x 20	180	13 x 20	220
									13 x 25	190
47	6.3 x 11	101	8 x 11	155	10 x 15	210	13 x 25	250	13 x 20	220
	8 x 11	125							13 x 25	260
68	8 x 11	159	10 x 12	198	10 x 19.5	241	13 x 25	270	16 x 20	242
									16 x 25	280
100	8 x 11	169	10 x 12	260	10 x 19.5	305	16 x 25	390	16 x 32	400
	10 x 12	210			13 x 20	385				
150	10 x 12	289	10 x 15	330	13 x 25	414	16 x 32	435	16 x 36	450
220	10 x 12	346	10 x 19.5	465	13 x 25	495	16 x 36	700	18 x 36	675
	10 x 15	400			16 x 25	590			18 x 40	750
330	10 x 19.5	535	13 x 20	650	16 x 25	720	18 x 40	850	18 x 40	780
	13 x 20	600							22 x 40	920
470	10 x 19.5	560	13 x 20	650	16 x 32	875	22 x 40	980	18 x 45	800
	13 x 20	730	13 x 25	800					22 x 40	920
680	13 x 25	860	16 x 25	1000	16 x 36	1200				
1000	16 x 25	1110	16 x 25	1023						
			16 x 32	1200						
1500	16 x 32	1350	16 x 36	1450						
2200	16 x 36	1360	18 x 45	1800						
	18 x 36	1530								

Note: I. Ripple Current: (mA/rms) 105°C, 120Hz



## CASE SIZE & PERMISSIBLE RIPPLE CURRENT OF STANDARD PRODUCTS

D x L: mm

CAP. (μF)	RATED VOLTAGE WV (SURGE VOLTAGE WV)													
	250 (300) SIZE		350 (400) SIZE		400 (450) SIZE		450 (500) SIZE							
		RIPPLE		RIPPLE		RIPPLE		RIPPLE						
0.47	5 x 11	12	6.3 x 11	14	6.3 x 11	14	6.3 x 11	16						
1.0	6.3 x 11	17	6.3 x 11	15	6.3 x 11	17	8 x 11	22						
			8 x 11	20	8 x 11	20								
2.2	6.3 x 11	23	10 x 12	35	8 x 11	29	10 x 12	37						
	8 x 11	29			10 x 12	35								
3.3	8 x 11	34	10 x 15	47	10 x 12	42	10 x 12	42						
	10 x 12	42			10 x 15	49			10 x 15	51				
4.7	8 x 11	41	10 x 12	43	10 x 12	66	10 x 15	59						
	10 x 12	52			10 x 15	57			10 x 15	57				
6.8	10 x 12	62	10 x 19.5	65	10 x 15	67	13 x 20	69						
10	10 x 15	75	10 x 15	65	10 x 19.5	75	10 x 19.5	72						
	10 x 19.5	88			13 x 20	95			13 x 20	97	13 x 25	99		
15	13 x 20	120	13 x 20	140	13 x 25	145	16 x 25	150						
22	13 x 20	130	13 x 20	125	13 x 20	120	16 x 25	145						
					13 x 25	155			16 x 25	165	13 x 25	140	16 x 32	175
									16 x 20	147				
					16 x 25	170								
33	13 x 25	200	16 x 20	150	16 x 20	164	16 x 32	211						
			16 x 32	195	16 x 25	190			18 x 36	250				
			18 x 16	148	16 x 32	230								
47	13 x 25	228	16 x 36	210	16 x 25	200	18 x 40	350						
					16 x 25	270			16 x 32	250				
									18 x 25	243				
									18 x 36	300				
68	16 x 32	300	18 x 36	320	18 x 25	310	18 x 32	320						
					18 x 36	325			22 x 40	380				
100	16 x 36	300	18 x 40	300	18 x 32	280								
	18 x 36	440			22 x 40	360			18 x 36	290				
									22 x 40	365	22 x 40	365		
120					18 x 32	300	18 x 45	420						
					18 x 36	320								
					18 x 40	350								
150	18 x 40	600	22 x 40	480	22 x 40	465								
220	22 x 40	800												

Note: I. Ripple Current: (mA/rms) 105°C, 120Hz

# SG [ Electronic Ballast ]

105°C Single-Ended Lead Aluminum Electrolytic Capacitors

## Miniature Aluminum Electrolytic Capacitors

### ELECTRICAL CHARACTERISTICS

Operating Temperature Range : -40 ~ +105°C / -25 ~ +105°C

Rated Voltage Range : 160 ~ 400V / 450V

Rated Capacitance Range : 4.7 ~ 330μF / 3.3~100μF

Capacitance Tolerance : -20 ~ +20% at 120Hz, 20°C

DC Leakage Current (μA):  $I = 0.06CV (\mu A) + 10\mu A$  whichever is greater.  
(After Rated Voltage Applied for 2 Minutes)

Dissipation Factor

WV (V) :	160	200	250	350	400	450
D.F. (%) :	15	15	15	20	24	24

Low Temperature Stability Impedance Ratio (Max.)

WV (V) :	160	200	250	350	400	450
Z - 25°C / Z + 20°C	3	3	3	5	5	6
Z - 40°C / Z + 20°C	6	6	6	6	6	-

Endurance : After the rated voltage and rated ripple current have been applied at 105°C for 5000 hours, the capacitors shall meet the following requirements.

- (a) Capacitance Change : Within 20% of Initial Value
- (b) Dissipation Factor : 200% or Less of Initial Specified Value
- (c) Leakage Current : Initial Specified Value or Less

Shelf Life : After having been placed at 105°C without voltage applied for 1000 hours, the capacitors shall meet the same requirements as Endurance.



### MULTIPLIER FOR RIPPLE CURRENT

Frequency Coefficient

FREQUENCY (Hz)	50	60	120	300
6.3~100V Below~68μF	0.8	0.8	1.0	1.2
FREQUENCY (Hz)	1K	10K~100K		
6.3~100V Below~68μF	1.4	1.6		

### DIAGRAM OF DIMENSIONS

Dimensions: mm

Dø	F	dø
5.0	2.0	0.5
6.3	2.5	
8.0	3.5	0.6
10.0	5.0	
12.0		
13.0		
16.0	7.5	0.8
18.0		
22.0	10.0	0.8 (1.0)

Rubber Stand-off

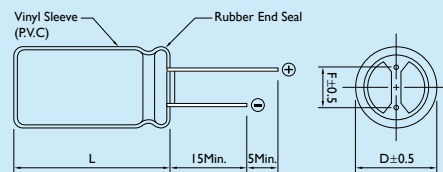

$L \leq 16 : L + 1.5\text{Max.}$   
 $L > 16 : L + 2\text{Max.}$   
 $D\phi = 8 \ \& \ 10 : L + 2.5\text{Max.}$

$D\phi < 20 : D\phi + 0.5$   
 $D\phi \geq 20 : D\phi + 1$

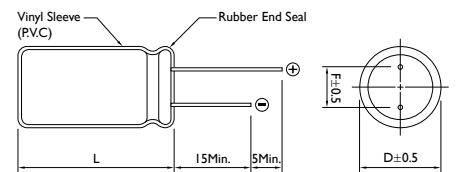



## CASE SIZE & PERMISSIBLE RIPPLE CURRENT OF STANDARD PRODUCTS

D x L: mm

CAP. (μF)	RATED VOLTAGE WV (SURGE VOLTAGE WV)					
	160 (200) SIZE		200 (250) SIZE		250 (300) SIZE	
		RIPPLE		RIPPLE		RIPPLE
10			*10 x 15	80	*10 x 15	85
					*10 x 19,5	100
15			*10 x 15	100		
22	10 x 19,5	160	10 x 19,5	160	*10 x 25	145
					13 x 20	160
33	10 x 19,5	210	*10 x 19,5	160	13 x 20	210
			13 x 20	210		
47	13 x 20	260	13 x 20	260	13 x 25	270
					16 x 20	275
68	13 x 25	360	13 x 25	360	16 x 25	380
	16 x 20	430	16 x 20	430	18 x 20	375
100	16 x 25	475	16 x 25	475	16 x 32	520
	18 x 20	465	18 x 20	465	18 x 25	500
150	16 x 32	650	18 x 25	650	18 x 32	650
	18 x 25	625				
220	16 x 32	750	18 x 32	780	18 x 40	820
	18 x 25	725				
330	18 x 32	960				

Note: 1. Ripple Current: (mA/rms) 105°C, 120Hz

2. \*Down size: 3000 Hours

## CASE SIZE & PERMISSIBLE RIPPLE CURRENT OF STANDARD PRODUCTS

D x L: mm

CAP. (μF)	RATED VOLTAGE WV (SURGE VOLTAGE WV)					
	350 (400) SIZE		400 (450) SIZE		450 (500) SIZE	
		RIPPLE		RIPPLE		RIPPLE
3.3					10 x 19.5	60
4.7			*10 x 15	60	13 x 20	80
6.8			*10 x 15	72	*10 x 19.5	90
10	10 x 19.5	100	10 x 19.5	100	13 x 20	110
					13 x 25	110
22	13 x 20	160	13 x 25	170	16 x 25	190
			16 x 20	200	18 x 20	200
33	13 x 25	230	16 x 25	230	16 x 32	275
	16 x 20	250	18 x 20	250	18 x 25	280
47	16 x 25	300	16 x 32	300	18 x 32	340
	18 x 20	315	18 x 25	325		
68	16 x 32	400	18 x 36	420	18 x 32	395
	18 x 25	380			18 x 40	460
100	18 x 32	530	18 x 40	545	22 x 40	580
150			22 x 40	650		

Note: 1. Ripple Current: (mA/rms) 105°C, 120Hz

2. \*Down size: 3000 Hours

# Miniature Aluminum Electrolytic Capacitors

# SP [ Miniature and Long Life ]

105°C Single-Ended Lead Aluminum Electrolytic Capacitors For Electronic Ballast

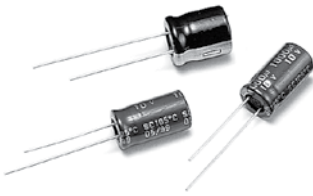

## DESCRIPTION

Applicable for Electronic Ballast

High Temperature Load Life at 105°C for 8000~10000 Hours

### MULTIPLIER FOR RIPPLE CURRENT

Frequency Coefficient

FREQUENCY (Hz)	120	1K	10K	100K
COEFFICIENT	1	1.6	1.8	2

Temperature Coefficient

TEMPERATURE (°C)	65	85	105
FACTOR	1.70	1.40	1.00

## ELECTRICAL CHARACTERISTICS

Operating Temperature Range : -40 ~ +105°C / -25 ~ +105°C

Rated Voltage Range : 160 ~ 400V / 450V

Rated Capacitance Range : 3.3 ~ 330μF

Capacitance Tolerance : -20 ~ +20% at 120Hz, 20°C

DC Leakage Current (μA) :  $I = 0.04CV$  (μA) + 100μA whichever is greater.  
(After Rated Voltage Applied for 2 Minutes)

Dissipation Factor

WV (V) :	160	200	400	450
D.F (%) :	20	20	24	24

Low Temperature Stability Impedance Ratio (Max.)

WV (V) :	160	200	400	450
Z - 25°C / Z + 20°C	3	3	5	6
Z - 40°C / Z + 20°C	6	6	6	-

Endurance: The following specifications shall be satisfied when the capacitors are stored at 20°C after subjected to DC Voltage with the maximum ripple current which is applied for 10,000 hours (8000 hours for 10ø) at 105°C.

- (a) Capacitance Change : Within 20% of Initial Value
- (b) Dissipation Factor : Not Exceeding 200% of Initial Requirement
- (c) Leakage Current : Not Exceeding the Initial Requirement

Shelf Life : After having been placed at 105°C without voltage applied for 1000 hours, the capacitors shall meet the same requirements as Endurance.

## DIAGRAM OF DIMENSIONS

Dimensions: mm

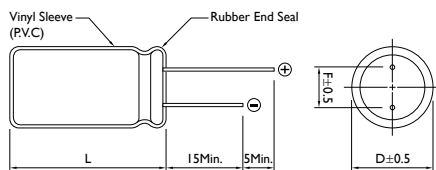

Rubber Stand-off

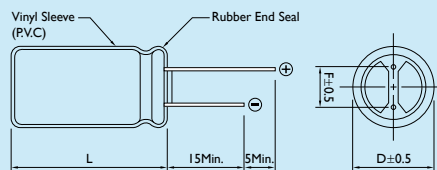

$L \leq 16L + 1.5\text{Max.}$   
 $I > 16L + 2\text{Max.}$   
 $D\phi = 8 \& 10L + 2.5\text{Max.}$

$D\phi < 20 \quad D\phi + 0.5$   
 $D\phi \geq 20 \quad D\phi + 1$

Dø	F	dø
10.0	5.0	0.6
12.0		
13.0		
16.0	7.5	0.8
18.0		
22.0	10.0	



## CASE SIZE & PERMISSIBLE RIPPLE CURRENT OF STANDARD PRODUCTS

D x L: mm

CAP. (μF)	RATED VOLTAGE WV (SURGE VOLTAGE WV)							
	160 (200) SIZE		200 (250) SIZE		400 (450) SIZE		450 (500) SIZE	
		RIPPLE		RIPPLE		RIPPLE		RIPPLE
3.3							10 x 15	100
4.7							10 x 19.5	140
6.8					10 x 19.5	150	10 x 19.5	150
							12.5 x 20	180
10					10 x 19.5	180	12.5 x 20	310
22			10 x 19.5	440	16 x 20	300	16 x 25	560
							18 x 20	550
33	10 x 19.5	500	10 x 19.5	520	16 x 25	520	16 x 32	620
			12.5 x 20	580			18 x 25	590
47	10 x 19.5	580	13 x 20	660	16 x 32	700	16 x 36	880
	12.5 x 20	660					18 x 32	880
68	12 x 25	720	13 x 25	720	18 x 32	870		
	16 x 20	760	16 x 20	760				
100	13 x 25	970	16 x 25	1120				
	16 x 20	1120						
	16 x 25	1120						
	18 x 20	1120						
150	16 x 25	1200	16 x 32	1280				
	16 x 32	1300						
	18 x 25	1300						
220	16 x 32	1300						
	18 x 25	1300						
330	18 x 36	1380						

Note: I. Ripple Current: (mA/rms) 105°C, 100KHz

# Miniature Aluminum Electrolytic Capacitors

# SB [ For Low Leakage Current ]

105°C Single-Ended Lead Aluminum Electrolytic Capacitors



## DESCRIPTION

Used in where low leakage current is essential as in coupling of pre-amplifiers.

Very low leakage current remains even after prolonged storage.

### MULTIPLIER FOR RIPPLE CURRENT

Frequency Coefficient

FREQUENCY (Hz)	50	120	300	1K	10K
6.3~25V	0.85	1.00	1.04	1.08	1.19
26~50V	0.80	1.00	1.30	1.40	1.43
50~100V	0.77	1.00	1.34	1.43	1.48

Temperature Coefficient

TEMPERATURE (°C)	60	70	85	105
FACTOR	1.95	1.75	1.20	1.00

## DIAGRAM OF DIMENSIONS

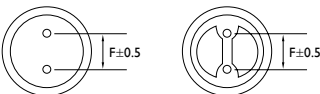

$D\phi < 20$   $D\phi + 0.5$   
 $D\phi \geq 20$   $D\phi + 1$

## ELECTRICAL CHARACTERISTICS

Operating Temperature Range : -40 ~ +105°C

Rated Voltage Range : 6.3 ~ 100V

Rated Capacitance Range : 0.1 ~ 4700 $\mu$ F

Capacitance Tolerance : -20 ~ +20% at 120Hz, 20°C

DC Leakage Current ( $\mu$ A) :  $I = 0.002CV$  ( $\mu$ A) or 0.4 $\mu$ A whichever is greater.  
 (After Rated Voltage Applied for 2 Minutes)

Dissipation Factor

WV (V) :	6.3	10	16	25	35	50 ~ 100
D.F. (%) :	24	20	16	14	12	10

When nominal capacitance is over 1000 $\mu$ F, tan  $\delta$  shall be added 0.02 to the listed value with increase of every 1000 $\mu$ F

Low Temperature Stability Impedance Ratio (Max.)

WV (V) :			6.3	10	16 ~ 25	35 ~ 63	80 ~ 100
Impedance : Z(120Hz) Z - 25°C / Z + 20°C			4	3	2	2	1.5
Z(120Hz) Z - 40°C / Z + 20°C			8	6	4	3	2

Endurance: After the rated voltage has been applied at 105°C for 1000 hours, the capacitors shall meet the following requirements.

- (a) Capacitance Change : Within 25% of Initial Value
- (b) Dissipation Factor : Not Exceeding 200% of Specified Value
- (c) Leakage Current : Not Exceeding the Specified Value

Shelf Life : After having been placed at 105°C without voltage application for 500 hours,

- (a) Capacitance Change : Within 25% of Initial Value
- (b) Dissipation Factor : Not Exceeding 200% of Specified Value
- (c) Leakage Current : Not Exceeding 200% of Specified Value

Dimensions: mm

Rubber Stand-off

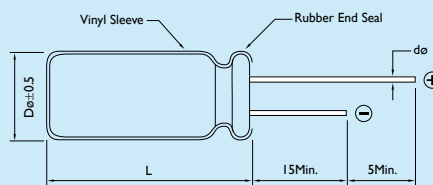

$L \leq 16$   $L + 1.5\text{Max.}$   
 $L > 16$   $L + 2\text{Max.}$   
 $D\phi = 8 \ \& \ 10$   $L + 2.5\text{Max.}$

Dø	F	dø
4.0	1.5	0.45
5.0	2.0	0.5
6.3	2.5	
8.0	3.5	0.6
10.0	5.0	
12.0		
13.0		
16.0	7.5	0.8
18.0		
22.0	10.0	

## CASE SIZE & PERMISSIBLE RIPPLE CURRENT OF STANDARD PRODUCTS

D x L: mm

CAP. (μF)	RATED VOLTAGE WV (SURGE VOLTAGE WV)					
	6.3 (8) SIZE		10 (13) SIZE		16 (20) SIZE	
		RIPPLE		RIPPLE		RIPPLE
10					5 x 11	40
15					5 x 11	56
22			5 x 11	68	6.3 x 11	70
33			6.3 x 11	78	6.3 x 11	95
47			6.3 x 11	106	6.3 x 11	100
					8 x 11	122
68	6.3 x 11	80	6.3 x 11	142	8 x 11	168
100	6.3 x 11	126	8 x 11	179	8 x 11	210
					10 x 12	264
150	8 x 11	196	8 x 11	220	10 x 15	416
			10 x 12	280		
220	10 x 12	272	10 x 15	355	10 x 19.5	553
330	10 x 15	388	10 x 19.5	480	13 x 20	732
470	10 x 19.5	507	13 x 20	640	13 x 20	1040
680	13 x 20	700	13 x 20	848	13 x 25	1280
820	13 x 25	850	13 x 25	980	16 x 25	1450
1000	13 x 25	896	13 x 25	1081	16 x 25	1700
1500	13 x 25	1204	16 x 25	1376	16 x 32	1750
2200	16 x 25	1513	16 x 32	1680	18 x 36	1900
3300	16 x 36	1902	16 x 36	2155	18 x 40	2250
4700	18 x 36	2272	18 x 40	2560		

Note: I. Ripple Current: (mA/rms) 105°C, 120Hz



## CASE SIZE & PERMISSIBLE RIPPLE CURRENT OF STANDARD PRODUCTS

D x L: mm

CAP. (μF)	RATED VOLTAGE WV (SURGE VOLTAGE WV)					
	25 (32) SIZE		35 (44) SIZE		50 (63) SIZE	
		RIPPLE		RIPPLE		RIPPLE
0.10					5 x 11	1
0.15					5 x 11	4
0.22					5 x 11	4
0.33					5 x 11	6
0.47					5 x 11	7
0.56					5 x 11	7
0.68					5 x 11	9
1.0					5 x 11	18
1.5					5 x 11	24
2.2					5 x 11	30
3.3					5 x 11	36
4.7	5 x 11	27	5 x 11	40	6.3 x 11	45
6.8	5 x 11	42	5 x 11	45	6.3 x 11	55
10	6.3 x 11	63	5 x 11	55	8 x 11	82
			6.3 x 11	67		
15	6.3 x 11	67	8 x 11	75	8 x 11	97
22	6.3 x 11	61	8 x 11	97	10 x 12	127
	8 x 11	84				
33	8 x 11	102	10 x 12	139	10 x 15	156
47	10 x 12	141	10 x 12	166	10 x 15	217
68	10 x 12	190	10 x 15	238	10 x 19.5	300
100	10 x 15	277	8 x 11	200	13 x 20	390
			10 x 19.5	310		
150	10 x 19.5	455	13 x 20	491	13 x 25	569
220	13 x 20	590	13 x 25	630	16 x 25	910
330	13 x 25	754	10 x 15	450	16 x 32	986
			16 x 25	771		
470	16 x 25	1110	16 x 25	1150	16 x 36	1249
680	16 x 32	1385	16 x 32	1462	16 x 36	1870
820	16 x 32	1540	16 x 36	1630	16 x 36	1950
1000	16 x 36	1710	18 x 36	1723	18 x 40	2070
1500	16 x 36	1779	18 x 40	2006		
2200	18 x 40	2174				

Note: I. Ripple Current: (mA/rms) 105°C, 120Hz

**CASE SIZE & PERMISSIBLE RIPPLE CURRENT OF STANDARD PRODUCTS**

D x L: mm

CAP. (μF)	RATED VOLTAGE WV (SURGE VOLTAGE WV)					
	63 (79) SIZE	RIPPLE	80 (100) SIZE	RIPPLE	100 (125) SIZE	RIPPLE
0.10	5 x 11	1	5 x 11	1	5 x 11	1
0.15	5 x 11	4	5 x 11	4	5 x 11	4
0.22	5 x 11	4	5 x 11	4	5 x 11	4
0.33	5 x 11	6	5 x 11	6	5 x 11	6
0.47	5 x 11	7	5 x 11	7	5 x 11	7
0.56	5 x 11	7	5 x 11	7	5 x 11	7
0.68	5 x 11	9	5 x 11	9	5 x 11	9
1.0	4 x 7	12	5 x 11	18	5 x 11	18
	5 x 11	18				
1.5	5 x 11	24	5 x 11	24	5 x 11	24
2.2	5 x 11	30	5 x 11	30	6.3 x 11	30
3.3	5 x 11	36	6.3 x 11	36	8 x 11	36
4.7	6.3 x 11	45	6.3 x 11	45	8 x 11	60
6.8	6.3 x 11	55	8 x 11	60	10 x 12	67
10	8 x 11	82	10 x 12	90	10 x 15	94
15	10 x 12	103	10 x 15	112	10 x 19.5	117
22	10 x 15	148	10 x 15	165	10 x 19.5	187
33	10 x 15	210	10 x 19.5	217	13 x 20	225
47	10 x 19.5	240	10 x 19.5	276	13 x 25	285
68	10 x 19.5	328	13 x 20	361	13 x 25	375
100	13 x 25	420	13 x 25	447	16 x 25	456
150	13 x 25	648	16 x 25	663	16 x 32	707
220	16 x 32	930	16 x 32	970	16 x 36	1010
330	16 x 36	1088	16 x 36	1198	18 x 36	1377
470	18 x 36	1385	18 x 36	1509		
680	18 x 36	1870				
820	18 x 40	1950				

Note: I. Ripple Current: (mA/rms) 105°C, 120Hz

# Miniature Aluminum Electrolytic Capacitors

# SN [ For Non-Polar ]

105°C Single-Ended Lead Aluminum Electrolytic Capacitors For Non-Polar General Purpose



## DESCRIPTION

Non-polar for used in reversing polarity DC voltage circuits.

### MULTIPLIER FOR RIPPLE CURRENT

Frequency Coefficient

FREQUENCY (Hz)	60	120	300	1K	10K
FACTOR	0.75	1.00	1.20	1.32	1.65

Temperature Coefficient

TEMPERATURE (°C)	65	85	105
FACTOR	1.30	1.20	1.00

## ELECTRICAL CHARACTERISTICS

Operating Temperature Range : -40 ~ +105°C / -25 ~ +105°C

Rated Voltage Range : 6.3 ~ 100V / 160 ~ 250V

Rated Capacitance Range : 0.22 ~ 2200μF / 0.47 ~ 100μF

Capacitance Tolerance : -20 ~ +20% at 120Hz, 20°C

DC Leakage Current (μA) :  $I = 0.03 CV + 3\mu A$   
(After Rated Voltage Applied for 2 Minutes)

Dissipation Factor

WV (V) :	6.3	10	16	25	35	50	63 ~ 100	160 ~ 250
D.F. (%) :	24	20	17	15	14	12	10	20

For capacitors whose capacitance exceeds 1000μF. The value of D.F is increased by 2% for every addition of 1000μF.

Endurance : 1000 Hours at 105°C with the Polarity Inverted Every 250 Hours

(a) Capacitance Change : Within 25% of Initial Value

(b) Dissipation Factor : Not Exceeding 200% of Specified Value

(c) Leakage Current : Not Exceeding the Specified Value

Shelf Life : After having been placed at 105°C without voltage applied for 500 hours, the capacitors shall meet the same requirements as Endurance.

## DIAGRAM OF DIMENSIONS

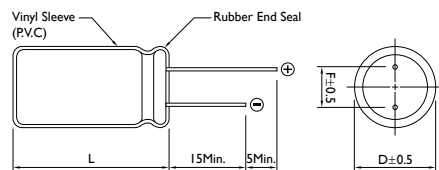

Rubber Stand-off

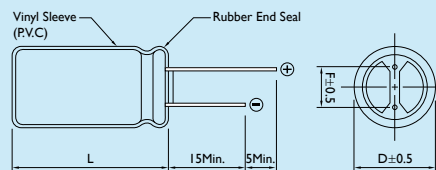

$L \leq 16$   $L + 1.5\text{Max.}$   
 $L > 16$   $L + 2\text{Max.}$   
 $D\phi = 8 \ \& \ 10$   $L + 2.5\text{Max.}$

$D\phi < 20$   $D\phi + 0.5$   
 $D\phi \geq 20$   $D\phi + 1$

Dimensions: mm

Dφ	F	dφ
4.0	1.5	0.45
5.0	2.0	0.5
6.3	2.5	
8.0	3.5	0.6
10.0	5.0	
12.0		
13.0		
16.0	7.5	0.8
18.0		
22.0	10.0	

**CASE SIZE & PERMISSIBLE RIPPLE CURRENT OF STANDARD PRODUCTS**

D x L: mm

CAP. (μF)	RATED VOLTAGE WV (SURGE VOLTAGE WV)									
	6.3 (8) SIZE		10 (13) SIZE		16 (20) SIZE		25 (32) SIZE		35 (44) SIZE	
	SIZE	RIPPLE	SIZE	RIPPLE	SIZE	RIPPLE	SIZE	RIPPLE	SIZE	RIPPLE
4.7									5 x 11	34
10					6.3 x 11	45	5 x 11	42	6.3 x 11	54
							6.3 x 11	50		
22			5 x 11	57	5 x 11	59	6.3 x 11	69	8 x 11	94
					6.3 x 11	69	8 x 11	86		
33	5 x 11	63	6.3 x 11	77	8 x 11	98	8 x 11	105	10 x 12	125
47	6.3 x 11	84	6.3 x 11	93	8 x 11	115	10 x 12	140	10 x 15	165
100	8 x 11	140	8 x 11	193	8 x 11	140	10 x 19.5	240	13 x 20	285
					10 x 12	175				
					10 x 15	205				
220	10 x 12	235	10 x 15	255	10 x 19.5	330	13 x 20	390	16 x 25	520
330	10 x 15	310	10 x 19.5	380	13 x 20	445	16 x 25	580	16 x 25	630
470	10 x 19.5	400	13 x 20	470	13 x 25	570	16 x 25	690	16 x 32	820
1000	13 x 25	690	16 x 25	885	16 x 32	1020				
2200	16 x 32	1250	16 x 36	1450						

Note: I. Ripple Current: (mA/rms) 105°C, 120Hz



## CASE SIZE & PERMISSIBLE RIPPLE CURRENT OF STANDARD PRODUCTS

D x L: mm

CAP. (μF)	RATED VOLTAGE WV (SURGE VOLTAGE WV)							
	50 (63) SIZE		63 (79) SIZE		80 (100) SIZE		100 (125) SIZE	
	SIZE	RIPPLE	SIZE	RIPPLE	SIZE	RIPPLE	SIZE	RIPPLE
0.22	5 x 11	5						
0.47	5 x 11	11	5 x 11	11	5 x 11	11	5 x 11	14
1.0	5 x 11	17	5 x 11	17	5 x 11	17	5 x 11	21
2.2	5 x 11	25	5 x 11	25	5 x 11	29	6.3 x 11	34
3.3	6.3 x 11	31	6.3 x 11	37	6.3 x 11	39	8 x 11	49
4.7	5 x 11	34	5 x 11	37	8 x 11	47	8 x 11	58
	6.3 x 11	41	6.3 x 11	44				
10	6.3 x 11	56	8 x 11	74	10 x 12	88	8 x 11	80
	8 x 11	70					10 x 12	100
22	6.3 x 11	75	8 x 11	95	10 x 19.5	150	13 x 20	180
	8 x 11	97	10 x 15	130				
	10 x 12	115						
33	8 x 11	110	8 x 11	115	13 x 20	205	13 x 20	220
	10 x 15	150	10 x 19.5	175				
47	8 x 11	130	13 x 20	230	13 x 20	245	13 x 25	285
	10 x 19.5	190						
100	13 x 20	310	16 x 25	410	16 x 25	435	16 x 32	510
220	16 x 25	570	16 x 32	660				
330	16 x 36	790						

Note: I. Ripple Current: (mA/rms) 105°C, 120Hz



**CASE SIZE & PERMISSIBLE RIPPLE CURRENT OF STANDARD PRODUCTS**

D x L: mm

CAP. (μF)	RATED VOLTAGE WV (SURGE VOLTAGE WV)					
	160 (200) SIZE		200 (250) SIZE		250 (300) SIZE	
		RIPPLE		RIPPLE		RIPPLE
0.47	6.3 x 11	14				
1.0	6.3 x 11	21	6.3 x 11	21	8 x 11	25
2.2	8 x 11	34	8 x 11	34	10 x 12	38
3.3	10 x 12	49	10 x 12	49	10 x 12	49
4.7	10 x 12	58	10 x 15	62	10 x 17	66
10	10 x 17	80	13 x 20	100	13 x 20	100
22	13 x 25	180	13 x 25	180	16 x 26	200
33	16 x 26	220	16 x 26	220	16 x 32	250
47	16 x 26	285	16 x 32	315	16 x 36	330
100	18 x 36	510				

Note: I. Ripple Current: (mA/rms) 105°C, 120Hz

# Miniature Aluminum Electrolytic Capacitors

# SR [ For Horizontal Deflection ]

Bi-Polarized Capacitors for Horizontal Deflection Circuits of TV Sets



## DESCRIPTION

Bi-Polarized Type for Used in Horizontal Deflection Current

Correction at High Frequency and High Ripple Currents

Lower Cost Compared with other Film Capacitors

### MULTIPLIER FOR RIPPLE CURRENT

Frequency Coefficient

FREQUENCY (Hz)	60	120	400~1K	15.75K
FACTOR	0.4	0.4	0.8	1.0

Temperature Coefficient

TEMPERATURE (°C)	65	70	85
FACTOR	1.15	1.00	0.80

## ELECTRICAL CHARACTERISTICS

Operating Temperature Range : -40 ~ +85°C

Rated Voltage Range : 25, 35, 50V

Rated Capacitance Range : 2.2 ~ 47μF

Capacitance Tolerance : -20 ~ +20% at 120Hz, 20°C

DC Leakage Current : 100μA Max.  
( After 2 Minutes Both Direction )

Dissipation Factor :

WV (V) :	25	35	50
D.F. (%) :	5	5	5

Endurance: After the rated voltage has been applied at 85°C for 1000 hours (Polarity Inverted Every 250 Hours) The Capacitors Shall Meet the Following Requirements.

(a) Capacitance Change : Within 20% of Initial Value

(b) Dissipation Factor : Not Exceeding 150% of Specified Value

(c) Leakage Current : Not Exceeding the Specified Value

Shelf Life : After having been placed at 85°C without voltage applied for 500 hours, the capacitors shall meet the same requirements as Endurance.

## DIAGRAM OF DIMENSIONS

Dimensions: mm

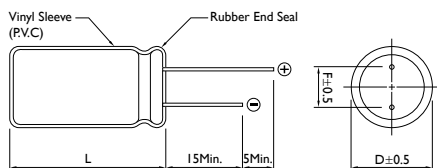

### Rubber Stand-off

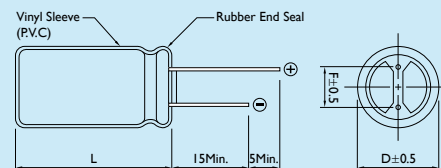

$L \leq 16$   $L + 1.5\text{Max.}$   
 $L > 16$   $L + 2\text{Max.}$   
 $D\phi = 8 \ \& \ 10$   $L + 2.5\text{Max.}$

$D\phi < 20$   $D\phi + 0.5$   
 $D\phi \geq 20$   $D\phi + 1$

D $\phi$	F	d $\phi$
12.0	5.0	0.6
13.0		
16.0	7.5	0.8
18.0		
22.0	10.0	0.8 (1.0)

## CASE SIZE & PERMISSIBLE RIPPLE CURRENT OF STANDARD PRODUCTS

D x L: mm

CAP. (μF)	RATED VOLTAGE WV (SURGE VOLTAGE WV)					
	25 (32) SIZE	RIPPLE	35 (44) SIZE	RIPPLE	50 (63) SIZE	RIPPLE
2.2	16 x 25	6	16 x 25	6	16 x 25	6
3.3	16 x 25	7	16 x 25	7	16 x 25	7
4.7	16 x 25	7	16 x 25	7	16 x 25	7
5.6	16 x 32	7	16 x 32	7	16 x 32	7
6.8	16 x 36	8	16 x 36	8	16 x 36	8
8.2	16 x 36	8	16 x 36	8	16 x 36	8
10	18 x 40	12	18 x 40	12	18 x 40	12
13	18 x 40	12	18 x 40	12	18 x 40	12
15	18 x 40	12	18 x 40	12	18 x 40	12
18	22 x 40	13	22 x 40	13	22 x 40	13
20	22 x 40	13	22 x 40	13	22 x 40	13
22	22 x 40	13	22 x 40	13	22 x 40	13
25	22 x 40	13	22 x 40	13	22 x 40	13
47	22 x 40	13	22 x 40	13	22 x 40	13

Note: I. Ripple Current: (Ap-p) / Sawtooth Waveform 85°C, 15.75KHz

# Miniature Aluminum Electrolytic Capacitors

## SC [ Low Impedance and Low ESR Suitable for Motherboard Output Termination ]

105°C Single-Ended Lead Aluminum Electrolytic Capacitors For High Frequency Applications

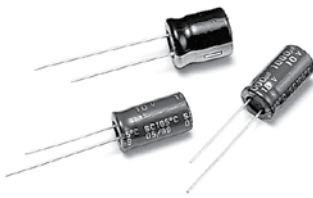

### DESCRIPTION

Applicable for switching regulator of computers, especially for high frequency

#### MULTIPLIER FOR RIPPLE CURRENT

Frequency Coefficient

FREQUENCY (Hz)	50	120	300	1K	10K
~4.7μF	0.30	0.40	0.50	0.70	0.80
5.6~33μF	0.40	0.50	0.60	0.80	0.90
34~330μF	0.60	0.70	0.80	0.90	0.95
331~1000μF	0.65	0.90	0.90	0.98	1.00
1200μF Higher	0.85	0.90	0.95	0.98	1.00

### ELECTRICAL CHARACTERISTICS

Operating Temperature Range : -40 ~ +105°C

Rated Voltage Range : 6.3 ~ 100V

Rated Capacitance Range : 4.7 ~ 15000μF

Capacitance Tolerance : -20 ~ +20% at 120Hz, 20°C

DC Leakage Current (μA) : I = 0.01CV or 3μA whichever is greater.  
(After Rated Voltage Applied for 2 Minutes)

Dissipation Factor

WV (V) :	6.3	10	16	25	35	50	63	100
D.F. (%) :	22	19	16	14	12	10	9	8

When nominal capacitance is over 1000μF, tan δ shall be added 0.02 to listed value with increase of every 1000μF.

WV (V) :						6.3	10	16	25	35	50	63	100
Impedance :	Z(120Hz)	Z - 25°C / Z + 20°C				4	3	3	3	3	2	2	2
	Z(120Hz)	Z - 40°C / Z + 20°C				8	6	4	4	4	4	4	4

Endurance : After the rated voltage has been applied at 105°C for 3000 hours, the capacitors shall meet the following requirements.

If Dimension is Down Size, Endurance will be Less 1000 hours than Standard

(a) Capacitance Change : Within ±20% of Initial Value

(b) Dissipation Factor: Not Exceeding 200% of Specified Value

(c) Leakage Current: Not Exceeding the Specified Value

CASE SIZE	5×11 ~ 10×12	10×15 higher
LIFE	2000	3000

Shelf Life : After having been placed at 105°C without voltage applied for 1000 hours, the capacitors shall meet the same requirements as Endurance.

### DIAGRAM OF DIMENSIONS

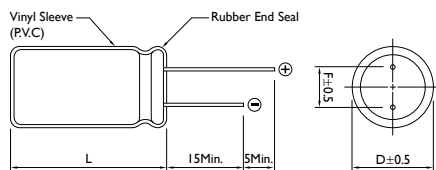

Rubber Stand-off

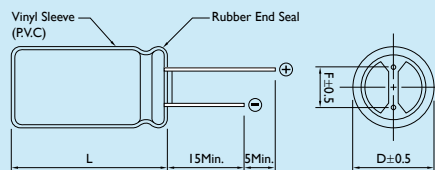

L ≤ 16 L + 1.5Max.  
L > 16 L + 2Max.

Dø = 8 & 10 L + 2.5Max.

Dø < 20 Dø + 0.5  
Dø ≥ 20 Dø + 1

Dimensions: mm

Dø	F	dø
4.0	1.5	0.45
5.0	2.0	0.5
6.3	2.5	
8.0	3.5	0.6
10.0	5.0	
12.0		
13.0		
16.0	7.5	0.8
18.0		
22.0	10.0	0.8 (1.0)

## CASE SIZE & PERMISSIBLE RIPPLE CURRENT OF STANDARD PRODUCTS

D x L: mm

CAP. (μF)	RATED VOLTAGE WV (SURGE VOLTAGE WV)											
	6.3 (8)			10 (13)			16 (20)			25 (32)		
	SIZE	RIPPLE	ESR	SIZE	RIPPLE	ESR	SIZE	RIPPLE	ESR	SIZE	RIPPLE	ESR
10										*4 × 7	40	2.000
										5 × 11	50	0.550
47										5 × 11	150	0.450
56							5 × 11	100	0.630	5 × 11	150	0.420
68							5 × 11	150	0.420	6.3 × 11	200	0.370
100				5 × 11	150	0.420	5 × 11	200	0.370	6.3 × 11	250	0.220
120				5 × 11	200	0.370	6.3 × 11	250	0.320	8 × 11	300	0.200
150	5 × 11	200	0.420	6.3 × 11	250	0.320	6.3 × 11	300	0.220	8 × 11	550	0.140
220	6.3 × 11	250	0.320	6.3 × 11	300	0.220	8 × 11	550	0.140	*8 × 11	620	0.120
										8 × 15	750	0.100
270	*6.3 × 11	300	0.220									
330	*6.3 × 11	320	0.230	8 × 11	550	0.140	*8 × 11	620	0.120	*8 × 15	660	0.100
	8 × 11	400	0.180				8 × 15	750	0.100	8 × 20	800	0.069
							10 × 12	688	0.080	10 × 15	900	0.086
470	*6.3 × 11	440	0.180	*8 × 11	620	0.120	*8 × 15	730	0.093	*8 × 20	1000	0.067
	8 × 11	550	0.140	8 × 15	750	0.100	10 × 12	800	0.085	*10 × 12	900	0.086
										10 × 15	1050	0.064
680	*8 × 11	580	0.120	*8 × 11	640	0.110	10 × 15	1050	0.064	10 × 19.5	1100	0.039
	8 × 15	700	0.100	10 × 12	800	0.085						
820	8 × 20	750	0.085	10 × 15	1050	0.064	10 × 19.5	1100	0.044	10 × 19.5	1250	0.039
1000	*8 × 11	580	0.150	8 × 20	1080	0.065	*10 × 15	1140	0.043	*10 × 19.5	1160	0.047
	*8 × 15	670	0.085	10 × 12	930	0.075	10 × 19.5	1250	0.039	*10 × 25	1310	0.042
	8 × 20	800	0.069	10 × 15	990	0.085				13 × 20	1450	0.038
	10 × 12	690	0.080	10 × 19.5	1100	0.050						
1200	10 × 15	1000	0.064	10 × 19.5	1250	0.044	*10 × 25	1310	0.042	13 × 25	1600	0.029
							13 × 20	1450	0.038			
1500	*8 × 15	980	0.085	10 × 19.5	1450	0.039	*10 × 19.5	1200	0.045	*12 × 30	1750	0.032
	*8 × 20	1070	0.051				13 × 20	1600	0.034	16 × 25	2000	0.028
	*10 × 15	1070	0.055									
	10 × 19.5	1250	0.044									

Note: 1. Ripple Current: (mA/rms) 105°C, 100KHz  
 2. ESR: 100KHz / 20°C (Ω Max.)  
 3. \* Down Size: 1000 Hours less than standard



## CASE SIZE & PERMISSIBLE RIPPLE CURRENT OF STANDARD PRODUCTS

D x L: mm

CAP. (μF)	RATED VOLTAGE WV (SURGE VOLTAGE WV)											
	6.3 (8)			10 (13)			16 (20)			25 (32)		
	SIZE	RIPPLE	ESR	SIZE	RIPPLE	ESR	SIZE	RIPPLE	ESR	SIZE	RIPPLE	ESR
2200	*10 × 19.5	1220	0.051	*10 × 19.5	1330	0.047	*10 × 30	1780	0.032	*13 × 30	1810	0.029
	*10 × 25	1310	0.048	*10 × 25	1450	0.039	*13 × 20	1720	0.033	*16 × 25	1660	0.032
	13 × 20	1450	0.043	13 × 20	1600	0.038	13 × 25	2000	0.028	16 × 32	2200	0.024
3300	*10 × 25	1400	0.043	*10 × 30	1740	0.032	*13 × 40	2200	0.026	*16 × 36	2540	0.019
	13 × 25	1700	0.035	13 × 25	2000	0.028	16 × 25	2200	0.024	18 × 36	2550	0.019
3900	13 × 25	1750	0.032									
4700	*12 × 30	1570	0.033	*13 × 25	1860	0.028	16 × 36	2550	0.019	18 × 36	2800	0.019
	*13 × 25	1520	0.032	16 × 25	2200	0.024						
	16 × 25	1800	0.028									
6800	16 × 32	2000	0.024	16 × 36	2550	0.019	18 × 36	2800	0.019	18 × 36	2800	0.019
8200	16 × 32	2350	0.019	18 × 36	2800	0.019						
10000	16 × 36	2550	0.019									
15000	18 × 36	3000	0.019									

Note: 1. Ripple Current: (mA/rms) 105°C, 100KHz

2. ESR: 100KHz / 20°C (Ω Max.)

3. \* Down Size: 1000 Hours less than standard

## CASE SIZE & PERMISSIBLE RIPPLE CURRENT OF STANDARD PRODUCTS

D x L: mm

CAP. (μF)	RATED VOLTAGE WV (SURGE VOLTAGE WV)											
	35 (44)			50 (63)			63 (79)			100 (125)		
	SIZE	RIPPLE	ESR	SIZE	RIPPLE	ESR	SIZE	RIPPLE	ESR	SIZE	RIPPLE	ESR
4.7	5 x 11	115	1.200	5 x 11	115	2.000	5 x 11	115	2.200	5 x 11	120	2.000
6.8	5 x 11	120	1.000	5 x 11	120	1.850	5 x 11	120	2.000	5 x 11	140	1.850
10	5 x 11	140	0.900	5 x 11	140	1.700	5 x 11	140	1.850	6.3 x 11	200	1.500
15	5 x 11	170	0.690	5 x 11	180	1.200	5 x 11	200	1.700	6.3 x 11	250	1.200
22	5 x 11	190	0.420	5 x 11	200	0.700	6.3 x 11	250	1.200	8 x 11	300	0.790
33	5 x 11	200	0.420	6.3 x 11	250	0.600	6.3 x 11	300	0.900	8 x 15	450	0.590
47	6.3 x 11	250	0.370	6.3 x 11	300	0.520	8 x 11	450	0.700	10 x 15	550	0.350
68	6.3 x 11	300	0.220	8 x 11	450	0.350	8 x 11	550	0.520	10 x 19.5	650	0.240
100	*6.3 x 11	360	0.180	*8 x 11	480	0.290	8 x 20	650	0.350	13 x 20	800	0.180
	8 x 11	450	0.140	8 x 15	550	0.250						
120	8 x 11	550	0.130	8 x 20	650	0.210	10 x 15	800	0.300	13 x 25	1050	0.150
150	8 x 15	650	0.100	10 x 12	800	0.160	10 x 15	1050	0.200	13 x 25	1300	0.110
220	*8 x 15	730	0.100	*10 x 15	1050	0.100	10 x 19.5	1300	0.150	16 x 25	1400	0.071
	10 x 12	800	0.069	10 x 25	1050	0.068						
330	*10 x 15	900	0.052	10 x 19.5	1300	0.072	13 x 20	1400	0.100	16 x 32	1550	0.049
	10 x 19.5	1050	0.044									
470	10 x 19.5	1300	0.039	*10 x 19.5	1390	0.075	13 x 25	1550	0.064	18 x 36	1770	0.038
				13 x 20	1400	0.060						
680	13 x 20	1400	0.038	13 x 25	1550	0.050	16 x 25	1700	0.052			
820	13 x 20	1550	0.034	16 x 25	1700	0.040	16 x 32	1900	0.048			
1000	13 x 25	1700	0.029	16 x 25	1900	0.039	16 x 32	2100	0.042			
1200	16 x 25	1900	0.028	16 x 32	2100	0.025	16 x 36	2550	0.036			
1500	16 x 25	2100	0.024	16 x 36	2550	0.025	18 x 36	2800	0.033			
2200	*16 x 32	2300	0.021	18 x 40	2800	0.025						
	16 x 36	2550	0.019									
3300	18 x 36	2880	0.019									

Note: 1. Ripple Current: (mA/rms) 105°C, 100KHz  
 2. ESR: 100KHz / 20°C (Ω Max.)  
 3. \* Down Size: 1000 Hours less than standard

# Miniature Aluminum Electrolytic Capacitors

# SJ [ Low Impedance and High Ripple Series ]

105°C 1000 ~ 5000 Hours, Low Impedance and High Ripple Current

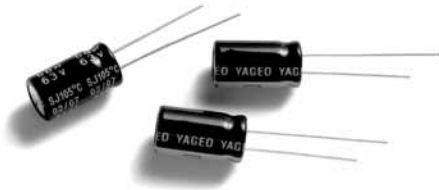

## DESCRIPTION

AV (TV, Video, Audio), Monitor / Computer, OA / HA / Communication, Converter / Inverter, Adapter, SMPS

### MULTIPLIER FOR RIPPLE CURRENT

Frequency Coefficient

FREQUENCY (Hz)	50	120	1K	10K	100K
5.6~390μF	0.60	0.70	0.85	0.95	1.00
470~1000μF	0.65	0.75	0.90	0.98	1.00
1200~6800μF	0.75	0.80	0.95	1.00	1.00

### ENDURANCE

CASE	LIFE TIME (HOURS)	
L = 7	1000	
L ≥ 11	Dø ≤ 6.3	2000
	Dø = 8	3000
	Dø = 10	4000
	Dø ≥ 13	5000

## ELECTRICAL CHARACTERISTICS

Operating Temperature Range : -40 ~ +105°C

Rated Voltage Range : 6.3 ~ 100V

Rated Capacitance Range : 5.6 ~ 6800μF

Capacitance Tolerance : -20 ~ +20% at 120KHz

DC Leakage Current (μA) : I = 0.01 CV (μA) or 3μA whichever is greater.

Dissipation Factor

WV (V) :	6.3	10	16	25	35	50	63	100	--
D.F. (%) :	22	19	16	14	12	10	9	8	--

WV (V) :	6.3	10	16	25	35	50	63	100
Impedance : Z - 25°C / Z + 20°C	2	2	2	2	2	2	2	2
	Z - 40°C / Z + 20°C	3	3	3	3	3	3	3

Endurance: After the rated voltage and maximum ripple current have been applied at 105°C for 1000 ~ 5000 hours, the capacitors shall meet the following requirements.

- (a) Capacitance Change: Within ±25% of the Initial Value
- (b) Dissipation Factor: Not Exceeding 200% of the Specified Value
- (c) Leakage Current: Not Exceeding the Specified Value

Shelf Life: After having been placed at 105°C without voltage applied for 1000 hours. (500 hours for L=7)  
The capacitors shall meet the same requirements as Endurance.

## DIAGRAM OF DIMENSIONS

Dimensions: mm

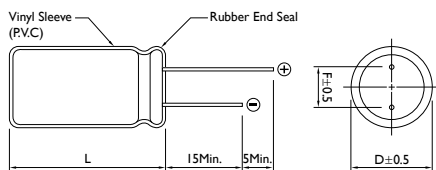

Rubber Stand-off

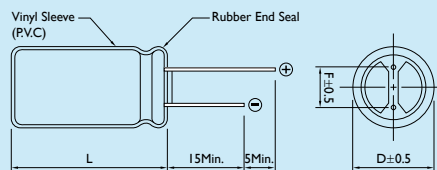

L ≤ 16 L + 1.5Max.  
L > 16 L + 2Max.  
Dø = 8 & 10 L + 2.5Max.

Dø < 20 Dø + 0.5  
Dø ≥ 20 Dø + 1

Dø	F	dø
4.0	1.5	0.45
5.0	2.0	0.5
6.3	2.5	
8.0	3.5	0.6
10.0	5.0	
13.0		
16.0	7.5	0.8
18.0		



## CASE SIZE & PERMISSIBLE RIPPLE CURRENT OF STANDARD PRODUCTS

D x L: mm

CAP. (μF)	RATED VOLTAGE WV (SURGE VOLTAGE WV)														
	6.3 (8)			10 (13)			16 (20)			25 (32)			35 (44)		
	SIZE	RIPPLE	ESR	SIZE	RIPPLE	ESR	SIZE	RIPPLE	ESR	SIZE	RIPPLE	ESR	SIZE	RIPPLE	ESR
10													4 x 7	130	0.96
15										4 x 7	130	0.94	5 x 7	190	0.57
18							4 x 7	130	0.92	5 x 7	170	0.69	5 x 7	210	0.47
27				4 x 7	130	0.89	5 x 7	190	0.61	5 x 7	210	0.46	5 x 11	230	0.37
33				5 x 7	160	0.75	5 x 7	210	0.45	5 x 11	220	0.42	5 x 11	250	0.30
39	4 x 7	130	0.85	5 x 7	175	0.64	5 x 11	220	0.43	5 x 11	230	0.36	6.3 x 7	300	0.25
47	5 x 7	175	0.70	5 x 7	190	0.53	5 x 11	230	0.36	5 x 11	250	0.30	6.3 x 11	380	0.15
													8 x 7	350	0.19
56	5 x 7	190	0.56	5 x 7	210	0.44	5 x 11	250	0.30	6.3 x 7	300	0.24	6.3 x 11	410	0.13
													8 x 7	380	0.16
68	5 x 7	210	0.43	5 x 11	210	0.44	6.3 x 7	300	0.24	6.3 x 11	340	0.19	8 x 11	510	0.12
										8 x 7	310	0.22			
100	5 x 11	200	0.43	5 x 11	250	0.30	6.3 x 11	370	0.16	6.3 x 11	410	0.13	8 x 11	620	0.105
	6.3 x 7	240	0.35				8 x 7	350	0.18	8 x 7	380	0.15			
120	5 x 11	220	0.38	6.3 x 7	300	0.23	6.3 x 11	410	0.13	8 x 11	560	0.12	8 x 11	680	0.088
	6.3 x 7	270	0.29				8 x 7	380	0.15						
150	5 x 11	250	0.30	8 x 7	350	0.18	8 x 11	510	0.12	8 x 11	630	0.105	8 x 11	760	0.072
	6.3 x 7	300	0.23												
180	8 x 7	340	0.18	8 x 7	380	0.15	8 x 11	560	0.11	8 x 11	690	0.088	8 x 15	910	0.068
													10 x 12	930	0.065
220	8 x 7	380	0.15	6.3 x 11	410	0.13	8 x 11	620	0.10	8 x 11	760	0.072	10 x 12	1030	0.053
270	6.3 x 11	370	0.16	8 x 11	580	0.12	8 x 11	690	0.088	8 x 15	900	0.068	8 x 20	1250	0.041
										10 x 12	930	0.065			
330	6.3 x 11	410	0.13	8 x 11	640	0.10	8 x 11	760	0.072	10 x 12	1030	0.053	10 x 15	1430	0.038
470	8 x 11	680	0.086	8 x 11	760	0.072	8 x 15	1000	0.056	8 x 20	1250	0.041	10 x 19.5	1820	0.026
							10 x 12	1030	0.053	10 x 15	1430	0.038			
560	8 x 11	760	0.072	8 x 15	910	0.068	8 x 20	1140	0.049	10 x 19.5	1650	0.032	10 x 25	2150	0.023
				10 x 12	940	0.064	10 x 15	1300	0.046						
680	8 x 15	900	0.062	10 x 12	1030	0.053	8 x 20	1250	0.041	10 x 19.5	1820	0.026	13 x 20	2360	0.023
							10 x 15	1430	0.038						

Note: 1. Ripple Current: (mA/rms) 105°C, 100KHz

2. ESR: 100KHz / 20°C (Ω Max.)



## CASE SIZE & PERMISSIBLE RIPPLE CURRENT OF STANDARD PRODUCTS

D x L: mm

CAP. (μF)	RATED VOLTAGE WV (SURGE VOLTAGE WV)														
	6.3 (8)			10 (13)			16 (20)			25 (32)			35 (44)		
	SIZE	RIPPLE	ESR	SIZE	RIPPLE	ESR	SIZE	RIPPLE	ESR	SIZE	RIPPLE	ESR	SIZE	RIPPLE	ESR
820	8 x 15	1000	0.056	8 x 20	1130	0.05	10 x 19.5	1650	0.032	10 x 25	2150	0.023	13 x 25	2510	0.02
				10 x 15	1300	0.046									
1000	10 x 12	1030	0.053	8 x 20	1250	0.041	10 x 19.5	1820	0.026	13 x 20	2360	0.021	13 x 25	2770	0.018
				10 x 15	1430	0.038									
1200	8 x 20	1250	0.041	10 x 19.5	1820	0.026	10 x 25	2150	0.023	13 x 25	2510	0.02	13 x 30	3290	0.016
	10 x 15	1430	0.038												
1500	10 x 19.5	1820	0.026	10 x 25	2150	0.023	13 x 20	2360	0.021	13 x 25	2770	0.018	13 x 35	3400	0.015
1800	10 x 25	1940	0.025	13 x 20	2230	0.022	13 x 25	2510	0.02	13 x 30	3290	0.016	16 x 25	3460	0.016
2200	10 x 25	2150	0.023	13 x 20	2360	0.021	13 x 25	2770	0.018	13 x 35	3400	0.015			
2700	13 x 20	2230	0.022	13 x 25	2510	0.02	13 x 30	3290	0.016	16 x 25	3460	0.016			
													16 x 20	3140	0.018
3300	13 x 20	2360	0.021	13 x 25	2770	0.018	13 x 35	3400	0.015						
3900	13 x 25	2770	0.018	13 x 30	3290	0.016	16 x 25	3460	0.016						
				16 x 20	3140	0.018									
4700	13 x 30	3290	0.016	13 x 35	3400	0.015									
5600	13 x 35	3400	0.015	16 x 25	3460	0.016									
	16 x 20	3140	0.018												
6800	16 x 25	3460	0.016												

Note: 1. Ripple Current: (mA/rms) 105°C, 100KHz

2. ESR: 100KHz / 20°C (Ω Max.)

## CASE SIZE & PERMISSIBLE RIPPLE CURRENT OF STANDARD PRODUCTS

D x L: mm

CAP. (μF)	RATED VOLTAGE WV (SURGE VOLTAGE WV)								
	50 (63) SIZE			63 (79) SIZE			100 (125) SIZE		
	SIZE	RIPPLE	ESR	SIZE	RIPPLE	ESR	SIZE	RIPPLE	ESR
5.6	4 x 7	130	1.00						
6.8	5 x 7	170	0.74				5 x 11	125	1.40
10	5 x 7	210	0.50				6.3 x 11	170	0.95
15	6.3 x 7	220	0.38	5 x 11	136	1.190	6.3 x 11	210	0.57
	5 x 11	215	0.48						
22	6.3 x 7	300	0.26	6.3 x 11	176	0.880	8 x 11	330	0.44
	5 x 11	240	0.34						
27	8 x 7	340	0.21	6.3 x 11	192	0.580	8 x 11	360	0.36
33	8 x 7	380	0.17	6.3 x 11	216	0.470	8 x 15	375	0.30
39	6.3 x 11	330	0.16	8 x 11	308	0.420	8 x 15	450	0.25
47	6.3 x 11	360	0.15	8 x 11	336	0.350	10 x 12	450	0.24
56	6.3 x 11	390	0.14	8 x 11	400	0.350	8 x 20	570	0.19
68	8 x 11	600	0.11	8 x 15	488	0.260	10 x 15	580	0.18
				10 x 12	500	0.240			
82	8 x 11	660	0.09	8 x 15	536	0.220	10 x 19.5	750	0.13
				10 x 12	552	0.200	13 x 16	740	0.13
100	8 x 11	730	0.074	10 x 15	640	0.160	10 x 25	880	0.12
120	8 x 15	950	0.065	8 x 20	656	0.160	13 x 20	1050	0.094
				10 x 15	760	0.150			
150	10 x 12	980	0.061	10 x 19.5	808	0.130	13 x 25	1100	0.085
				13 x 16	832	0.130			
180	8 x 20	1190	0.046	10 x 19.5	880	0.110	13 x 25	1200	0.071
				13 x 16	912	0.110			
220	10 x 15	1370	0.042	10 x 25	1040	0.099	13 x 30	1410	0.063
							16 x 20	1300	0.071
270	10 x 19.5	1580	0.03	13 x 20	1200	0.081	13 x 35	1560	0.052
							16 x 25	1600	0.053
							18 x 20	1470	0.069
330	10 x 25	1870	0.028	13 x 25	1480	0.058	13 x 40	1700	0.046
390	13 x 20	1870	0.028	13 x 30	1640	0.063	16 x 32	1750	0.041
				16 x 20	1448	0.073	18 x 25	1620	0.049

Note: 1. Ripple Current: (mA/rms) 105°C, 100KHz  
 2. ESR: 100KHz / 20°C (Ω Max.)



## CASE SIZE & PERMISSIBLE RIPPLE CURRENT OF STANDARD PRODUCTS

D x L: mm

CAP. (μF)	RATED VOLTAGE WV (SURGE VOLTAGE WV)								
	50 (63)			63 (79)			100 (125)		
	SIZE	RIPPLE	ESR	SIZE	RIPPLE	ESR	SIZE	RIPPLE	ESR
470	13 x 20	2050	0.027	13 x 30	1800	0.061	16 x 36	1890	0.033
				16 x 20	1592	0.061			
560	13 x 25	2410	0.023	13 x 25	1960	0.047	16 x 40	2080	0.03
				16 x 25	2040	0.043			
680	13 x 30	2860	0.021	13 x 40	2224	0.039	18 x 40	2570	0.028
				18 x 20	1960	0.052			
820	13 x 35	2960	0.019	16 x 32	2248	0.035			
	16 x 20	2730	0.023	18 x 25	2224	0.042			
1000	16 x 32	3350	0.021	16 x 36	2227	0.028			
				18 x 32	2616	0.034			
1200				16 x 40	2672	0.026			
				18 x 36	2648	0.027			
1500				18 x 40	2736	0.024			

Note: 1. Ripple Current: (mA/rms) 105°C, 100KHz

2. ESR: 100KHz / 20°C (Ω Max.)

# Miniature Aluminum Electrolytic Capacitors

## SQ [ For Adapter and Power Supply Applications Series ]

105°C 2000 Hours, Wide Temperature Range and Low Impedance

### ELECTRICAL CHARACTERISTICS

Operating Temperature Range : -40 ~ +105°C

Rated Voltage Range : 160V ~ 450DC

Rated Capacitance Range : 2.2 ~ 220μF

Capacitance Tolerance : -20 ~ +20% at 120Hz, 20°C

DC Leakage Current (μA) :  $I \leq 0.03CV + 10\mu A$  (After Rated Voltage Applied for 3 Minutes)

I = Leakage Current (μA), C = Nominal Capacitance (μF), V = Rated Voltage (V)

Dissipation Factor

WV (V) :	160	200	250	350	400	450	
D.F. (%) :	15	15	15	24	24	24	

WV (V) :		160	200	250	350	400	450
Impedance : Z - 25°C / Z + 20°C		3	3	3	3	3	3
Z - 40°C / Z + 20°C		6	6	6	6	6	6

Endurance : After the rated voltage has been applied at 105°C for 2000 hours. The capacitors shall meet the following requirements.

- (a) Capacitance Change : Within 20% of Initial Value
- (b) Dissipation Factor : Not Exceeding 200% of the Specified Value
- (c) Leakage Current : Not Exceeding the Specified Value

Shelf Life: After leaving capacitors under no load at 105°C for 1000 hours, the capacitors shall meet the same requirements as Endurance.

### DIAGRAM OF DIMENSIONS

Dimensions: mm

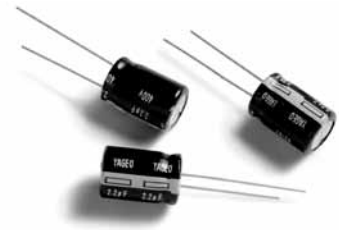
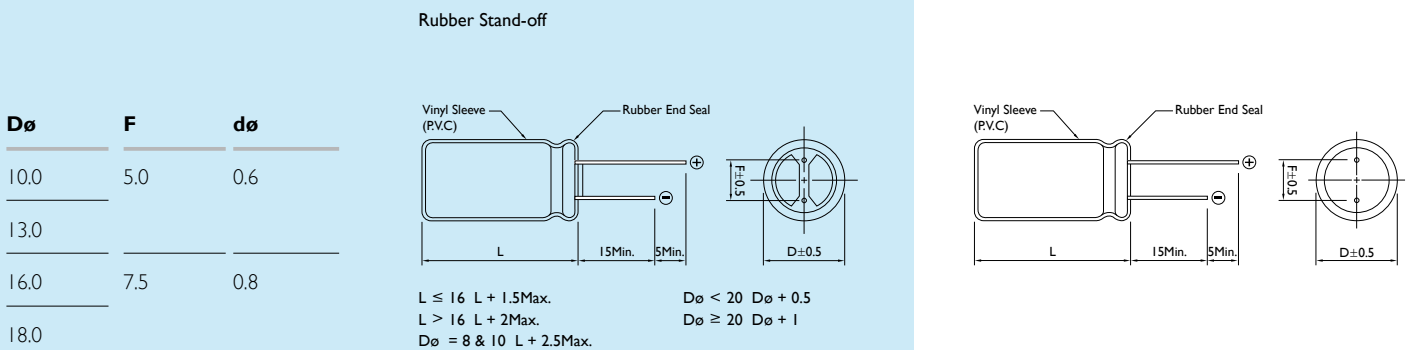

### DESCRIPTION

Recommended Applications: AV (TV, Video, Audio), Monitor / Computer, OA / HA / Communication, Converter / Inverter, Energy Saving Lamp, PFC Circuit, SMPS, Ballast, Adapter

### MULTIPLIER FOR RIPPLE CURRENT

Frequency Coefficient

FREQUENCY (Hz)	50	120	1K	10K	100K
< 33μF	0.80	1.00	1.36	1.54	1.80
≥ 34μF	0.85	1.00	1.28	1.35	1.40



## CASE SIZE & PERMISSIBLE RIPPLE CURRENT OF STANDARD PRODUCTS

D x L: mm

CAP. (μF)	RATED VOLTAGE WV (SURGE VOLTAGE WV)								
	160 (200)			200 (250)			250 (300)		
	SIZE	RRIPPLE 120Hz	100KHz	SIZE	RRIPPLE 120Hz	100KHz	SIZE	RRIPPLE 120Hz	100KHz
10							10 x 19.5	120	220
22	10 x 19.5	195	350	10 x 19.5	195	350	13 x 25	165	300
33	13 x 20	315	450	13 x 20	365	520	13 x 25	280	400
47	13 x 25	420	600	13 x 25	420	600	16 x 25	505	720
68	13 x 25	420	600	16 x 25	665	950	16 x 32	570	810
100	16 x 25	665	950	16 x 32	840	1200	18 x 36	735	1050
220	18 x 36	980	1400						

Note: I. Ripple Current: (mA/rms) 105°C, 120Hz & 100KHz

## CASE SIZE & PERMISSIBLE RIPPLE CURRENT OF STANDARD PRODUCTS

D x L: mm

CAP. (μF)	RATED VOLTAGE W V (SURGE VOLTAGE W V)								
	350 (400)			400 (450)			450 (500)		
	SIZE	RIPPLE 120Hz	100KHz	SIZE	RIPPLE 120Hz	100KHz	SIZE	RIPPLE 120Hz	100KHz
2.2	10 × 15	30	50	10 × 15	80	140	10 × 15	60	110
3.3	10 × 15	35	60	10 × 19.5	110	195	10 × 19.5	75	135
4.7	10 × 19.5	45	78	10 × 25	120	220	13 × 20	105	190
10	13 × 20	75	130	13 × 25	200	360	13 × 25	140	250
22	16 × 25	115	205	16 × 25	315	570	16 × 32	265	480
33	16 × 32	180	255	16 × 32	490	700	18 × 36	455	650
47	18 × 32	225	320	18 × 32	600	860			
82							18 × 36	520	720
100	18 × 45	370	530						
120							18 × 40	720	1000

Note: I. Ripple Current: (mA/rms) 105°C, 120Hz & 100KHz

# Miniature Aluminum Electrolytic Capacitors

## SY [ For Low Impedance and Low ESR Suitable for Motherboard Output Termination ]

105°C Single-Ended Lead Aluminum Electrolytic Capacitors for High Frequency Applications



### DESCRIPTION

Features: Low ESR, high permissible ripple current at high frequency and long life than SC

Recommended Applications: Used switching regulator applications in computers

Especially for high frequency

### MULTIPLIER FOR RIPPLE CURRENT

Frequency Coefficient

FREQUENCY (Hz)	120	1K	10K	100K
22~180μF	0.40	0.75	0.90	1.00
220~560μF	0.50	0.85	0.94	1.00
680~1800μF	0.60	0.87	0.95	1.00
2200~3900μF	0.75	0.90	0.95	1.00
4700μF Higher	0.85	0.95	0.98	1.00

### ELECTRICAL CHARACTERISTICS

Operating Temperature Range : -40 ~ +105°C

Rated Voltage Range : 6.3 ~ 100V

Rated Capacitance Range : 6.8 ~ 15,000μF

Capacitance Tolerance : -20 ~ +20% at 120Hz, 20°C

Leakage Current (Max.) (20°C):  $I = 0.01CV$  or  $3\mu A$  whichever is greater.  
(After Rated Voltage Applied for 2 Minutes)

$I$  = Leakage Current ( $\mu A$ ),  $C$  = Nominal Capacitance ( $\mu F$ ),  $V$  = Rated Voltage (V)

Dissipation Factor

WV (V) :	6.3	10	16	25	35	50	63	100	--
D.F. (%) :	22	19	16	14	12	10	9	8	--

When nominal capacitance is over 1,000μF,  $\tan \delta$  shall be added 0.02 to the listed value with increase of every 1000μF.

WV (V) :	Rated Voltage (V)		6.3	10	16	25	35	50	63	100
Impedance :	Z - 25°C / Z + 20°C		4	3	2	2	2	2	2	2
	Z - 40°C / Z + 20°C		8	6	4	3	3	3	3	3

Endurance

D $\phi$ :	5 $\phi$ ~6.3 $\phi$	8 $\phi$ ~10 $\phi$ x12.5	10 $\phi$ x15~12 $\phi$	13 $\phi$ ~18 $\phi$
Life :	3000hrs	4000hrs	5000hrs	6000hrs

After the rated voltage has been applied at 105°C for 6000 hours. The capacitors shall meet the following requirements.

- (a) Capacitance Change : Within 25% of Initial Value
- (b) Dissipation Factor : Not Exceeding 200% of Specified Value
- (c) Leakage Current : Not Exceeding the Specified Value

Shelf Life : After having been placed at 105°C without voltage applied for 1000 hours, the capacitors shall meet the same requirements as Endurance.

### DIAGRAM OF DIMENSIONS

Dimensions: mm

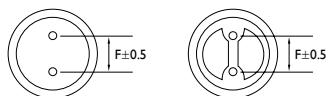

$D\phi < 20$   $D\phi + 0.5$   
 $D\phi \geq 20$   $D\phi + 1$

Rubber Stand-off

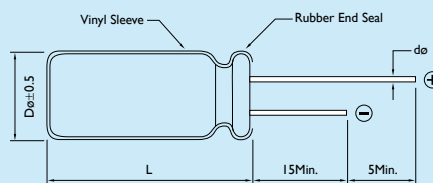

$L \leq 16$   $L + 1.5Max.$   
 $L > 16$   $L + 2Max.$   
 $D\phi = 8 \& 10$   $L + 2.5Max.$

D $\phi$	F	d $\phi$
5.0	2.0	0.5
6.3	2.5	
8.0	3.5	0.6
10.0	5.0	
12.0		
13.0		
16.0	7.5	0.8
18.0		



## CASE SIZE & PERMISSIBLE RIPPLE CURRENT OF STANDARD PRODUCTS

D x L: mm

CAP. (μF)	RATED VOLTAGE WV (SURGE VOLTAGE WV)								
	6.3 (8) SIZE			10 (13) SIZE			16 (20) SIZE		
	SIZE	RIPPLE	ESR	SIZE	RIPPLE	ESR	SIZE	RIPPLE	ESR
56							5 × 11	210	0.580
100				5 × 11	210	0.58	6.3 × 11	250	0.230
120							6.3 × 11	340	0.220
150	5 × 11	210	0.58						
220				6.3 × 11	340	0.22	6.3 × 11	469	0.185
							8 × 11	582	0.150
330	6.3 × 11	340	0.22				8 × 11	640	0.130
470	6.3 × 11	510	0.16	8 × 11	640	0.13	*8 × 15	840	0.087
							8 × 20	950	0.078
							*10 × 12	865	0.080
							10 × 15	1210	0.060
680	8 × 11	640	0.13	8 × 15	840	0.087	8 × 20	1050	0.069
							10 × 15	1210	0.060
820	10 × 12	865	0.08	10 × 12	865	0.08			
1000	8 × 15	840	0.087	8 × 20	1050	0.069	8 × 20	1050	0.069
							10 × 15	1210	0.06
							*10 × 15	1210	0.060
							10 × 19.5	1400	0.046
1200	8 × 20	1050	0.069	10 × 19.5	1400	0.046	10 × 25	1650	0.042
							10 × 15	1210	0.06
1500	8 × 20	1050	0.069	10 × 25	1650	0.042	10 × 30	1910	0.031
	*10 × 15	1210	0.06	13 × 15	1450	0.049	13 × 20	1900	0.035
	10 × 19.5	1400	0.046				16 × 15	1940	0.042
1800	13 × 15	1450	0.049						
2200	*10 × 19.5	1400	0.046	10 × 30	1910	0.031	13 × 25	2230	0.027
	10 × 25	1650	0.042	13 × 20	1900	0.042	18 × 15	2210	0.043
				16 × 15	1940	0.042			
2700	10 × 30	1910	0.031	18 × 15	2210	0.043	13 × 30	2650	0.024
	16 × 15	1940	0.042				16 × 20	2530	0.027

Note: 1. Ripple Current: (mA/rms) 105°C, 100KHz

2. ESR: 100KHz / 20°C (Ω Max.)

3. \* Down Size: 1000 Hours less than standard

4. For case size 13 × 15, 16 × 15 and 18 × 15, tolerance of height = ±3 mm



## CASE SIZE & PERMISSIBLE RIPPLE CURRENT OF STANDARD PRODUCTS

D x L: mm

CAP. (μF)	RATED VOLTAGE WV (SURGE VOLTAGE WV)								
	6.3 (8)			10 (13)			16 (20)		
	SIZE	RIPPLE	ESR	SIZE	RIPPLE	ESR	SIZE	RIPPLE	ESR
3300	10 x 25	1650	0.042	10 x 30	1910	0.031	13 x 36	2880	0.020
	13 x 20	1900	0.035	13 x 25	2230	0.027			
3900	13 x 25	2230	0.027	13 x 30	2650	0.024	13 x 40	3350	0.017
	18 x 15	2210	0.043	16 x 20	2530	0.027	16 x 25	2930	0.021
		18 x 20	2860				0.026		
4700	13 x 30	2650	0.024	13 x 35	2880	0.02	16 x 32	3450	0.017
							18 x 25	3140	0.019
5600	13 x 35	2880	0.02	13 x 40	3350	0.017	16 x 36	3610	0.015
	16 x 20	2530	0.027	16 x 25	2930	0.021	18 x 32	4170	0.015
				18 x 20	2860	0.026			
6800	13 x 40	3350	0.017	16 x 32	3450	0.017	16 x 40	4080	0.013
	16 x 25	2930	0.021	18 x 25	3140	0.019			
	18 x 20	2860	0.026						
8200	16 x 32	3450	0.017	16 x 36	3610	0.015	18 x 36	4220	0.014
				18 x 32	4170	0.015			
10000	16 x 36	3610	0.015	16 x 40	4080	0.013	18 x 40	4280	0.012
	18 x 25	3410	0.017	18 x 36	4220	0.014			
12000	18 x 32	4170	0.015	18 x 40	4280	0.012			
15000	18 x 36	4220	0.014						

Note: 1. Ripple Current: (mA/rms) 105°C, 100KHz

2. ESR: 100KHz / 20°C (Ω Max.)

3. For case size 13 x 15, 16 x 15 and 18 x 15, tolerance of height = ±3 mm

## CASE SIZE & PERMISSIBLE RIPPLE CURRENT OF STANDARD PRODUCTS

D x L: mm

CAP. (μF)	RATED VOLTAGE WV (SURGE VOLTAGE WV)								
	25 (32) SIZE			35 (44) SIZE			50 (63) SIZE		
	SIZE	RIPPLE	ESR	SIZE	RIPPLE	ESR	SIZE	RIPPLE	ESR
2.2							5 × 11	85	2.280
4.7				5 × 11	130	2.400	5 × 11	135	2.000
10				5 × 11	275	0.390	5 × 11	100	1.200
22							5 × 11	180	0.700
33				5 × 11	210	0.580	6.3 × 11	245	0.490
47	5 × 11	210	0.580	6.3 × 11	275	0.390	6.3 × 11	300	0.520
56				6.3 × 11	340	0.220	6.3 × 11	295	0.300
68				6.3 × 11	500	0.170			
82				6.3 × 11	540	0.160			
100	6.3 × 11	340	0.220	6.3 × 11	580	0.150	8 × 11	555	0.170
120							8 × 15	730	0.120
150	8 × 11	640	0.160	8 × 11	640	0.130	10 × 12	760	0.120
180							8 × 20	910	0.091
220	8 × 11	640	0.130	*8 × 15	840	0.087	10 × 15	1050	0.084
				10 × 12	865	0.080			
270				8 × 20	1050	0.069	10 × 19.5	1220	0.060
							13 × 15	1260	0.061
330	8 × 15	840	0.087	*10 × 15	1210	0.060	*10 × 19.5	1400	0.058
	10 × 12	865	0.080	10 × 19.5	1400	0.046	10 × 25	1440	0.055
470	8 × 20	1050	0.069	13 × 15	1450	0.049	13 × 20	1660	0.045
	*10 × 12	1050	0.070				16 × 15	1690	0.055
	10 × 15	1210	0.060						
560				10 × 25	1650	0.042	13 × 25	1950	0.034
							18 × 15	1930	0.054
680	10 × 19.5	1400	0.046	10 × 30	1910	0.031	13 × 30	2310	0.030
	13 × 15	1450	0.049	13 × 20	1900	0.035			
				16 × 15	1940	0.042			
820	10 × 25	1650	0.042	13 × 20	1900	0.035	13 × 36	2510	0.025
							16 × 20	2210	0.034

Note: 1. Ripple Current: (mA/rms) 105°C, 100KHz

2. ESR: 100KHz / 20°C (Ω Max.)

3. \* Down Size: 1000 Hours less than standard

4. For case size 13 × 15, 16 × 15 and 18 × 15, tolerance of height = ±3 mm



## CASE SIZE & PERMISSIBLE RIPPLE CURRENT OF STANDARD PRODUCTS

D x L: mm

CAP. (μF)	RATED VOLTAGE WV (SURGE VOLTAGE WV)								
	25 (32) SIZE			35 (44) SIZE			50 (63) SIZE		
	SIZE	RIPPLE	ESR	SIZE	RIPPLE	ESR	SIZE	RIPPLE	ESR
1000	10 × 19.5	1400	0.046	13 × 25	2230	0.027	13 × 40	2920	0.021
	10 × 30	1910	0.031	18 × 15	2210	0.043	16 × 25	2555	0.025
	13 × 20	1900	0.035				18 × 20	2490	0.036
	16 × 15	1940	0.042						
1200	18 × 15	2210	0.043	13 × 30	2650	0.024	16 × 32	3010	0.022
				16 × 20	2530	0.027	18 × 25	2740	0.026
1500	*13 × 20	1900	0.035	13 × 35	2880	0.020	16 × 36	3510	0.019
	13 × 25	2230	0.027						
1800	13 × 30	2650	0.024	13 × 40	3350	0.017	16 × 40	3710	0.016
	16 × 20	2530	0.027	16 × 25	2930	0.021	18 × 32	3635	0.021
				18 × 20	2860	0.026			
2200	13 × 35	2880	0.020	16 × 32	3450	0.017	18 × 36	3680	0.017
	18 × 20	2860	0.026	18 × 25	3140	0.019			
2700	13 × 40	3350	0.017	16 × 36	3610	0.015	18 × 40	3800	0.014
	16 × 25	2930	0.021	18 × 32	4170	0.015			
3300	16 × 32	3450	0.017	16 × 40	4080	0.013			
	18 × 25	3140	0.019	18 × 36	4220	0.014			
3900	18 × 32	4170	0.015	18 × 40	4280	0.012			
4700	18 × 36	4220	0.014						
5600	18 × 40	4280	0.012						

Note: 1. Ripple Current: (mA/rms) 105°C, 100KHz

2. ESR: 100KHz / 20°C (Ω Max.)

3. \* Down Size: 1000 Hours less than standard

4. For case size 13 × 15, 16 × 15 and 18 × 15, tolerance of height = ±3 mm

## CASE SIZE & PERMISSIBLE RIPPLE CURRENT OF STANDARD PRODUCTS

D x L: mm

CAP. (μF)	RATED VOLTAGE WV (SURGE VOLTAGE WV)					
	63 (79) SIZE			100 (125) SIZE		
		RIPPLE	ESR		RIPPLE	ESR
6.8				5 × 11	55	2.30
15	5 × 11	55	2.30	6.3 × 11	115	1.20
27				8 × 11	232	0.63
33	6.3 × 11	115	1.20			
39				8 × 15	300	0.45
47				10 × 12	288	0.43
56	8 × 11	232	0.63	8 × 20	362	0.33
68				10 × 15	357	0.31
82	8 × 15	300	0.45	10 × 19.5	466	0.21
	10 × 12	288	0.43	13 × 15	466	0.23
100				10 × 25	531	0.20
120	8 × 20	362	0.33	10 × 30	663	0.15
	10 × 15	357	0.31	13 × 20	690	0.16
150				16 × 16	795	0.14
180	10 × 19.5	466	0.21	13 × 25	784	0.12
	13 × 15	466	0.23	18 × 15	920	0.12
220	10 × 25	531	0.20	13 × 30	905	0.10
				16 × 20	1040	0.091
270	10 × 30	663	0.15	13 × 35	1050	0.083
	13 × 20	690	0.16	16 × 25	1250	0.073
	16 × 16	795	0.14			
330	13 × 25	784	0.12	13 × 40	1180	0.071
				18 × 20	1240	0.08
390	18 × 16	920	0.12	16 × 32	1570	0.054
				18 × 25	1490	0.057
470	13 × 30	905	0.10	16 × 36	1790	0.045
	16 × 20	1040	0.091	18 × 32	1630	0.047
560	13 × 35	1050	0.083	16 × 40	2020	0.04
	16 × 25	1250	0.073			
680	13 × 40	1180	0.071	18 × 36	1790	0.04
	18 × 20	1240	0.080			
820	16 × 32	1570	0.054	18 × 40	2330	0.036
	18 × 25	1490	0.057			
1000	16 × 36	1790	0.045			
	18 × 32	1630	0.047			
1200	16 × 40	2020	0.04			

Note: 1. Ripple Current: (mA/rms) 105°C, 100KHz

2. ESR: 100KHz / 20°C (Ω Max.)

3. For case size 13 × 15, 16 × 15 and 18 × 15, tolerance of height = ±3 mm

# Miniature Aluminum Electrolytic Capacitors

## SZ [ Ultra Low ESR ]

105°C Single-Ended Lead Aluminum Electrolytic Capacitors for High Frequency Applications

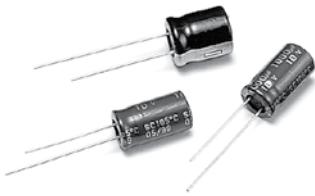

### DESCRIPTION

Used in switching regulator applications in computers, especially for high frequency.

Low impedance and ESR, high permissible ripple current at high frequency and higher operating temperature (-40°C to +105°C).

High Temperature Load Life at 105°C for 2000 Hours

#### MULTIPLIER FOR RIPPLE CURRENT

Frequency Coefficient

FREQUENCY (Hz)	120	1K	10K	100K
FACTOR	0.50	0.80	0.90	1.00

Temperature Coefficient

TEMPERATURE (°C)	65	85	105
FACTOR	2.10	1.70	1.00

### ELECTRICAL CHARACTERISTICS

Operating Temperature Range : -40 ~ +105°C

Rated Voltage Range : 6.3 ~ 16V

Rated Capacitance Range : 470 ~ 3300μF

Capacitance Tolerance : -20 ~ +20% at 120Hz, 20°C

DC Leakage Current (μA) :  $I = 0.03 CV$  whichever is greater.  
(After Rated Voltage Applied for 2 Minutes)

Dissipation Factor

WV (V) :	6.3	10	16
D.F. (%) :	22	19	16

When nominal capacitance is over 1000μF, tan δ shall be added 0.02 to the listed value with increase of every 1000μF.

WV (V) :	Rated Voltage (V)	6.3	10	16
Impedance :	Z - 25°C / Z + 20°C	2	2	2
	Z - 40°C / Z + 20°C	3	3	3

Endurance: After the rated voltage has been applied at 105°C for 2000 hours, the capacitors shall meet the following requirements.

- (a) Capacitance Change : Within ±25% of Initial Value
- (b) Dissipation Factor : Not Exceeding 200% of Specified Value
- (c) Leakage Current : Not Exceeding the Specified Value

Shelf Life: After having been placed at 105°C without voltage applied for 1000 hours, the capacitors shall meet the same requirements as Endurance.

### DIAGRAM OF DIMENSIONS

Dimensions: mm

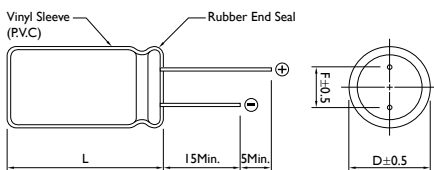

Rubber Stand-off

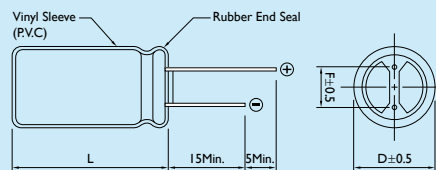

$L \leq 16$   $L + 1.5\text{Max.}$   
 $L > 16$   $L + 2\text{Max.}$   
 $D\phi = 8 \ \& \ 10$   $L + 2.5\text{Max.}$

$D\phi < 20$   $D\phi + 0.5$   
 $D\phi \geq 20$   $D\phi + 1$

Dφ	F	dφ
4.0	1.5	0.45
5.0	2.0	0.5
6.3	2.5	
8.0	3.5	0.6
10.0	5.0	
12.0		
13.0		
16.0	7.5	0.8
18.0		
22.0	10.0	

## CASE SIZE & PERMISSIBLE RIPPLE CURRENT OF STANDARD PRODUCTS

D x L: mm

CAP. (μF)	RATED VOLTAGE WV (SURGE VOLTAGE WV)								
	6.3 (8)			10 (13)			16 (20)		
	SIZE	RIPPLE	ESR	SIZE	RIPPLE	ESR	SIZE	RIPPLE	ESR
470							8 x 11	1036	43
680				8 x 11	1036	43	8 x 15	1355	34
							10 x 12	1400	31
820	8 x 11	1036	43						
1000				8 x 15	1355	34	8 x 20	1700	25
				10 x 12	1400	31	10 x 15	1818	23
1200	8 x 15	1355	34						
1500	8 x 20	1740	25	8 x 20	1700	25	10 x 19.5	2318	16
	10 x 12	1400	31	10 x 15	1818	23			
1800	10 x 15	1818	23	10 x 19.5	2318	16	10 x 25	2546	14
2200	10 x 19.5	2318	15	10 x 25	2545	14			
3300	10 x 25	2364	14						

Note: 1. Ripple Current: (mA/rms) 105°C, 100KHz  
 2. ESR: 100KHz / 20°C (mΩ Max.)

# Miniature Aluminum Electrolytic Capacitors

# ST [ Low Impedance and Long Life ]

105°C 4000 ~ 10000 Hours, Low Impedance and Long Life

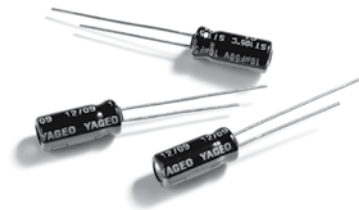

## DESCRIPTION

Applicable for SMPS, Adaptor, Charger, Monitor/ Computer

### MULTIPLIER FOR RIPPLE CURRENT

Frequency Coefficient

FREQUENCY (Hz)	120	1K	10K	100K
6.8~180μF	0.40	0.75	0.90	1.00
220~560μF	0.50	0.85	0.94	1.00
680~1800μF	0.60	0.87	0.95	1.00
2200~3900μF	0.75	0.90	0.95	1.00
4700μF Higher	0.85	0.95	0.98	1.00

## ELECTRICAL CHARACTERISTICS

Operating Temperature Range : -40 ~ +105°C

Rated Voltage Range : 6.3 ~ 63V

Rated Capacitance Range : 6.8 ~ 15000μF

Capacitance Tolerance : ±20% at 120Hz, 20°C

Leakage Current (Max.) (20°C):  $I = 0.01CV$  or  $3\mu A$  whichever is greater. (After Rated Voltage Applied for 2 Minutes)  $I$  = Leakage Current ( $\mu A$ ),  $C$  = Nominal Capacitance ( $\mu F$ ),  $V$  = Rated Voltage (V)

Dissipation Factor (Max.) (tan $\delta$ ) (120Hz, 20°C)

WV (V) :	6.3	10	16	25	35	50	63
D.F. (%) :	22	19	16	14	12	10	9

When nominal capacitance is over 1000μF, tan $\delta$  shall be added 0.02 to the listed value with increase of every 1000μF.

Low Temperature Stability Impedance Ratio (Max.)

WV (V) :	6.3	10	16	25	35	50	63
Z - 25°C / Z + 20°C :	4	3	2	2	2	2	2
Z - 40°C / Z + 20°C :	8	6	4	3	3	3	3

Endurance

VDC :	5 $\emptyset$ ~6.3 $\emptyset$	8 $\emptyset$ ~10 $\emptyset$	12.5 $\emptyset$ ~18 $\emptyset$
6.3~10 (V) :	4000hrs	6000hrs	8000hrs
16~100 (V) :	5000hrs	7000hrs	10000hrs

After the rated voltage has been applied at 105°C for 4000~10000 hours. The capacitors shall meet the following requirements.

- (a) Capacitance Change: Within ±25% of Initial Value
- (b) Dissipation Factor: 200% or Less of Initial Specified Value
- (c) Leakage Current: Initial Specified Value or Less

Shelf Life: After having been placed at 105°C without voltage applied for 1000 hours, the capacitors shall meet the same requirements as load life.

## DIAGRAM OF DIMENSIONS

Dimensions: mm

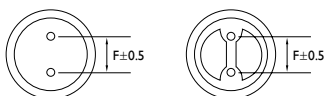

$D\emptyset < 20$   $D\emptyset + 0.5$   
 $D\emptyset \geq 20$   $D\emptyset + 1$

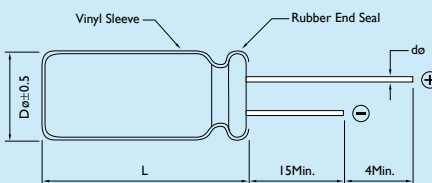

D $\emptyset$	F	d $\emptyset$
5.0	1.5	0.5
6.3		
8.0		0.6
10.0		
13.0	2.0	
16.0		0.8
18.0		



## CASE SIZE & PERMISSIBLE RIPPLE CURRENT OF STANDARD PRODUCTS

D x L: mm

CAP. (μF)	RATED VOLTAGE WV (SURGE VOLTAGE WV)											
	6.3 (8)			10 (13)			16 (20)			25 (32)		
	SIZE	RIPPLE	ESR	SIZE	RIPPLE	ESR	SIZE	RIPPLE	ESR	SIZE	RIPPLE	ESR
47										5 x 11	210	0.720
56							5 x 11	210	0.720			
100				5 x 11	210	0.720	6.3 x 11	340	0.380	6.3 x 11	340	0.380
150	5 x 11	210	0.720							8 x 11	640	0.200
220				6.3 x 11	340	0.380	8 x 11	640	0.200	8 x 11	640	0.200
330	6.3 x 11	340	0.380				8 x 15	701	0.160	8 x 15	840	0.160
470				8 x 11	640	0.200	8 x 15	840	0.160	10 x 15	1210	0.084
680	8 x 11	640	0.200	8 x 15	840	0.160	10 x 15	1210	0.084	10 x 19.5	1400	0.062
820	8 x 15	840	0.160									
1000	10 x 12	865	0.120	10 x 15	1210	0.084	10 x 19.5	1400	0.062	13 x 20	1900	0.046
1500	8 x 20	1050	0.110	10 x 19.5	1400	0.062	10 x 25	1650	0.052	13 x 25	2230	0.034
	10 x 15	1210	0.084									
2200	10 x 19.5	1400	0.062	10 x 25	1650	0.052	13 x 25	2230	0.034	13 x 35	2880	0.027
2700	10 x 25	1650	0.052	13 x 20	1900	0.046	13 x 30	2650	0.030	16 x 25	2930	0.028
3300	13 x 20	1900	0.046	13 x 25	2230	0.034	13 x 35	2880	0.027	16 x 32	3450	0.025
3900	13 x 25	2230	0.034	13 x 30	2650	0.030	13 x 40	3350	0.024	18 x 32	4170	0.015
4700	13 x 30	2650	0.030	13 x 35	2880	0.027	16 x 25	3450	0.028	18 x 36	4280	0.014
5600	13 x 35	2880	0.027	13 x 40	3550	0.024	16 x 36	3610	0.018			
				16 x 25	2930	0.028	18 x 32	4170	0.015			
6800	13 x 40	3350	0.024	16 x 32	3450	0.025	18 x 36	4220	0.014			
	16 x 25	2930	0.028									
8200	16 x 32	3450	0.025	16 x 36	3610	0.018						
10000	16 x 36	3610	0.018	18 x 36	4220	0.014						
12000	18 x 32	4170	0.015									
15000	18 x 36	4220	0.014									

Note: 1. Ripple Current: (mA/rms) 105°C, 100KHz  
 2. ESR: 100KHz / 20°C (Ω)



## CASE SIZE & PERMISSIBLE RIPPLE CURRENT OF STANDARD PRODUCTS

D x L: mm

CAP. (μF)	RATED VOLTAGE WV (SURGE VOLTAGE WV)								
	35 (44) SIZE			50 (63) SIZE			63 (79) SIZE		
	SIZE	RIPPLE	ESR	SIZE	RIPPLE	ESR	SIZE	RIPPLE	ESR
10							5 x 11	55	2.300
22				5 x 11	210	2.300			
33	5 x 11	210	0.720	6.3 x 11	340	1.200	6.3 x 11	115	1.200
47	6.3 x 11	340	0.380	6.3 x 11	340	1.200			
56							8 x 11	232	0.630
100				8 x 11	555	0.630			
120				8 x 15	730	0.450	10 x 15	357	0.310
150	8 x 11	640	0.200	8 x 20	910	0.330			
180							10 x 19.5	466	0.210
220	8 x 15	840	0.160	10 x 15	1050	0.310	10 x 25	531	0.200
270							10 x 30	663	0.150
							13 x 20	690	0.160
330	10 x 19.5	1400	0.062	10 x 19.5	1400	0.210	13 x 25	784	0.120
470	10 x 25	1650	0.052	10 x 30	1690	0.150	13 x 30	905	0.100
				13 x 20	1660	0.160			
560				13 x 25	1950	0.120	13 x 35	1050	0.083
680	10 x 30	1910	0.044	13 x 30	2310	0.100	13 x 40	1180	0.071
	13 x 20	1900	0.046						
820	13 x 25	2230	0.034	13 x 35	2510	0.083	16 x 32	1570	0.054
1000	13 x 25	2230	0.034	16 x 25	2555	0.073	16 x 36	1790	0.045
1200	13 x 30	2650	0.030	16 x 32	3010	0.054	16 x 40	2020	0.040
1500	13 x 35	2880	0.027	16 x 36	3150	0.045			
1800	13 x 40	3350	0.024	18 x 32	3635	0.047			
2200	16 x 32	3450	0.025	18 x 36	3680	0.040			
2700	16 x 36	3610	0.018	18 x 40	3800	0.036			
3300	18 x 36	4220	0.014						

Note: 1. Ripple Current: (mA/rms) 105°C, 100KHz

2. ESR: 100KHz / 20°C (Ω)

# SD [ For High Ripple Current ]

105°C 5000 Hours, Long Life

## Miniature Aluminum Electrolytic Capacitors

### ELECTRICAL CHARACTERISTICS

Operating Temperature Range : -25 ~ +105°C

Rated Voltage Range : 160 ~ 450V

Rated Capacitance Range : 22 ~ 330 $\mu$ F

Capacitance Tolerance :  $\pm$ 20% at 120Hz, 20°C

Leakage Current (Max.) (20°C):  $I \leq 0.02CV + 15\mu A$  whichever is greater.

(After Rated Voltage Applied for 5 Minutes)

$I$  = Leakage Current ( $\mu A$ ),  $C$  = Nominal Capacitance ( $\mu F$ ),  $V$  = Rated Voltage (V)

Dissipation Factor (Max.) ( $\tan\delta$ ) (120Hz, 20°C)

WV (V) :	160	200	250	400	420	450
D.F. (%) :	18	18	18	20	22	24

Temperature Characteristics (Max.) ( $\tan\delta$ ) (120Hz, 20°C)

WV (V) :	160	200	250	400	420	450
Z-25°C/Z+20°C :	4	4	5	6	6	6

Endurance:

After the rated voltage and rated ripple current have been applied at 105°C for 5000 hours, the capacitors shall meet the following requirements.

- (a) Capacitance Change : Within  $\pm$ 20% of Initial Value
- (b) Dissipation Factor:  $\leq$  2 Times of the Initial Specified Value
- (c) Leakage Current:  $\leq$  The Initial Specified Value

Shelf Life: After leaving capacitors under no load at 105°C for 1000 hours.

- (a) Capacitance Change : Within  $\pm$ 20% of Initial Value
- (b) Dissipation Factor:  $\leq$  2 Times of the Initial Specified Value
- (c) Leakage Current:  $\leq$  2 Times of the Initial Specified Value

### DIAGRAM OF DIMENSIONS

D $\phi$	F	d $\phi$	Max
8.0	3.5	0.6	2.0
10.0	5.0		
12.5			

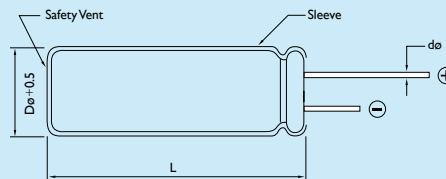

D $\phi$  = 8 & 10, L + 2.5 Max.

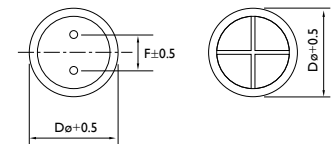

D $\phi$  < 20 D $\phi$  + 0.5  
D $\phi$   $\geq$  20 D $\phi$  + 1

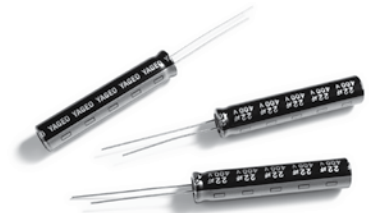

### DESCRIPTION

Applicable for used in super thin TV, with high ripple current capability.

### MULTIPLIER FOR RIPPLE CURRENT

Frequency Coefficient

FREQUENCY (Hz)	60	120	300	1K	10K	100K $\leq$
COEFFICIENT	0.75	1.00	1.25	1.35	1.50	1.50

Dimensions: mm



## CASE SIZE & PERMISSIBLE RIPPLE CURRENT OF STANDARD PRODUCTS

D x L: mm

CAP. (μF)	RATED VOLTAGE WV (SURGE VOLTAGE WV)											
	160 (200)		200 (250)		250 (300)		400 (420)		420 (450)		450 (500)	
	SIZE	RIPPLE	SIZE	RIPPLE	SIZE	RIPPLE	SIZE	RIPPLE	SIZE	RIPPLE	SIZE	RIPPLE
22							8 x 45	225	8 x 50	235	8 x 50	255
27							8 x 50	265	10 x 40	265	10 x 45	285
33					8 x 40	225	10 x 40	300	10 x 45	305	10 x 50	320
39					8 x 45	245	10 x 45	330	10 x 50	350	12.5 x 40	380
47					8 x 50	305	12.5 x 35	400	12.5 x 40	420	12.5 x 45	450
56	8 x 35	260	8 x 45	285	10 x 40	335	12.5 x 40	470	12.5 x 45	480	12.5 x 50	500
68	8 x 40	335	8 x 50	350	10 x 45	380	12.5 x 45	530	12.5 x 50	560	12.5 x 55	585
82	8 x 45	390	10 x 40	460	10 x 50	440	12.5 x 50	610	12.5 x 55	625	12.5 x 60	635
100	8 x 50	470	10 x 45	490	12.5 x 45	530	12.5 x 55	715	12.5 x 60	730		
120	10 x 40	520	10 x 50	570	12.5 x 50	600						
150	10 x 50	650	12.5 x 45	710	12.5 x 55	735						
180	12.5 x 40	745	12.5 x 50	785	12.5 x 60	830						
220	12.5 x 45	830	12.5 x 55	880								
270	12.5 x 50	960	12.5 x 60	1030								
330	12.5 x 55	1100										

Note: I. Ripple Current: (mA/rms) 105°C, 120Hz

# SL [ Long Life and Low Impedance ]

105°C 3000 ~ 7000 Hours, High Ripple Current and Long Life

## Miniature Aluminum Electrolytic Capacitors

### ELECTRICAL CHARACTERISTICS

Operating Temperature Range: -40 ~ +105°C / -25 ~ +105°C

Rated Voltage Range: 6.3 ~ 100V / 160 ~ 450V

Rated Capacitance Range: 2.2 ~ 18000μF

Capacitance Tolerance: ±20% at 120Hz, 20°C

Leakage Current (Max.) (20°C): I = 0.01CV or 3μA whichever is greater:

(After Rated Voltage Applied for 2 Minutes)

CV ≤ 1000: I = 0.1CV+40μA (max.), CV > 1000: I = 0.04CV+100μA (max.) (After 1 minute)

Dissipation Factor (Max.) (tanδ) (120Hz, 20°C)

WV (V) :	6.3	10	16	25	35	50	63	100	160~250	40~450
D.F. (%) :	22	19	16	14	12	10	9	8	20	24

When nominal capacitance exceeds 1000μF, add 0.02 to the value above for each 1000μF increase.

Temperature Characteristics (Impedance Ratio at 120Hz)

WV (V) :	6.3	10	16	25	35	50	63	100	160~250	400	450
Z-25°C/Z+20°C :	4	3	3	3	3	3	2	2	3	5	6
Z-40°C/Z+20°C :	8	6	4	4	3	3	3	3			

Endurance: After the rated voltage has been applied at 105°C and then has resumed its original condition for 16 hours.

Dø :	6.3ø	8ø	10ø	12.5ø
Load Life :	3000hrs	4000hrs	5000hrs	7000hrs

- (a) Capacitance Change: ±25% of the Initial Measured Value
- (b) Dissipation Factor: ≤ The Initial Specified Value
- (c) Leakage Current: ≤ 2 Times of the Initial Specified Value

Shelf Life: After having been stored at 105°C for 1000 hours, and then has resumed its original condition for 16 hours.

- (a) Capacitance Change: ±25% of the Initial Measured Value
- (b) Dissipation Factor: ≤ The Initial Specified Value
- (c) Leakage Current: ≤ 2 Times of the Initial Specified Value

### DIAGRAM OF DIMENSIONS

Dø	F	dø
6.3	2.5	0.5
8.0	3.5	0.6
10.0	5.0	
12.5		
16.0	7.5	0.8
18.0		

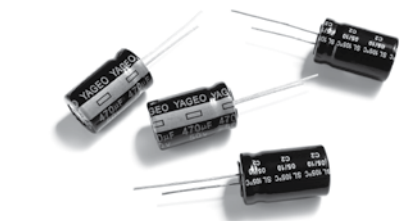
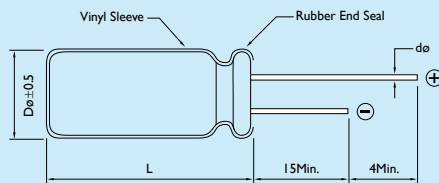

### DESCRIPTION

Excellent Ripple Current Capability

Used in communication equipment, switching power supplies, industrial measuring.

### MULTIPLIER FOR RIPPLE CURRENT

Frequency Coefficient

FREQUENCY (Hz)	120	1K	10K	100K
~180μF	0.40	0.75	0.90	1.00
220~560μF	0.50	0.85	0.94	1.00
680~1800μF	0.60	0.87	0.95	1.00
2200~3900μF	0.75	0.90	0.95	1.00
4700~18000μF	0.85	0.95	0.98	1.00

Dimensions: mm

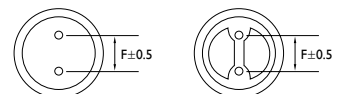

Dø ≤ 20 Dø + 0.5  
Dø ≥ 20 Dø + 1



## CASE SIZE & PERMISSIBLE RIPPLE CURRENT OF STANDARD PRODUCTS

D x L: mm

CAP. (μF)	RATED VOLTAGE WV (SURGE VOLTAGE WV)								
	6.3 (8) SIZE			10 (13) SIZE			16 (20) SIZE		
	SIZE	RIPPLE	ESR	SIZE	RIPPLE	ESR	SIZE	RIPPLE	ESR
100							6.3 x 11	298	0.286
120							6.3 x 11	298	0.286
150				6.3 x 11	298	0.286			
180				6.3 x 11	298	0.286	8 x 11	561	0.169
220	6.3 x 11	298	0.286	6.3 x 11	298	0.286	8 x 11	561	0.169
				8 x 11	561	0.169			
270	6.3 x 11	298	0.286				8 x 11	561	0.169
330	6.3 x 11	298	0.286	8 x 11	561	0.169	8 x 11	561	0.169
	8 x 11	561	0.169						
390	8 x 11	561	0.169	8 x 11	561	0.169	10 x 12	759	0.104
470	8 x 11	561	0.169	8 x 11	561	0.169	10 x 15	737	0.113
560	8 x 11	561	0.169	10 x 12	759	0.104	10 x 15	1061	0.078
680				8 x 15	737	0.113	8 x 20	921	0.090
				10 x 12	759	0.104	10 x 15	1061	0.078
820	8 x 15	737	0.113	10 x 15	1061	0.078	10 x 19.5	1228	0.060
	10 x 15	1061	0.078				12.5 x 15	1272	0.064
1000	10 x 15	1061	0.078	8 x 20	921	0.090	10 x 19.5	1228	0.060
				10 x 15	1061	0.078	10 x 25	1447	0.055
1200	8 x 15	921	0.090	10 x 19.5	1228	0.060	10 x 25	1447	0.055
				12.5 x 15	1272	0.064	16 x 15	1649	0.065
1500	10 x 19.5	1228	0.060	10 x 25	1447	0.055	10 x 30	1675	0.040
	12.5 x 15	1272	0.064				16 x 15	1570	0.072
1800	10 x 25	1447	0.055	10 x 19.5	1228	0.060	12.5 x 25	1863	0.039
				16 x 15	1649	0.065	18 x 15	1687	0.073
2200	10 x 25	1447	0.055	16 x 20	1938	0.046	12.5 x 25	1863	0.039
	16 x 15	1649	0.065				16 x 20	1938	0.046
2700	10 x 30	1675	0.040	12.5 x 25	1863	0.039	12.5 x 30	2214	0.034
	16 x 15	1649	0.065	18 x 15	1772	0.066	16 x 20	1938	0.046
3300	18 x 15	1772	0.066	12.5 x 30	2214	0.034	12.5 x 35	2406	0.029
				16 x 20	1938	0.046	18 x 20	2188	0.044

Note: 1. Ripple Current: (mA/rms) 105°C, 100KHz

2. ESR: 100KHz / 20°C (Ω)

## CASE SIZE & PERMISSIBLE RIPPLE CURRENT OF STANDARD PRODUCTS

D x L: mm

CAP. (μF)	RATED VOLTAGE WV (SURGE VOLTAGE WV)								
	6.3 (8) SIZE			10 (13) SIZE			16 (20) SIZE		
	SIZE	RIPPLE	ESR	SIZE	RIPPLE	ESR	SIZE	RIPPLE	ESR
3900	12.5 x 25	1863	0.039	12.5 x 35	2406	0.029	16 x 25	2238	0.036
				16 x 20	1938	0.046	18 x 20	2188	0.044
4700	12.5 x 30	2214	0.034	12.5 x 40	2798	0.025	16 x 30	2657	0.029
	16 x 20	1938	0.046	16 x 25	2238	0.036	18 x 25	2430	0.031
5600	12.5 x 35	2406	0.029	16 x 25	2238	0.036	16 x 35	2740	0.026
	16 x 20	1938	0.046	18 x 20	2188	0.044	18 x 30	3157	0.026
6800	12.5 x 40	2798	0.025	16 x 30	2657	0.029	16 x 40	3408	0.022
	16 x 30	2657	0.029	18 x 25	2430	0.031			
	18 x 25	2430	0.031						
8200	16 x 35	2740	0.026	16 x 35	2740	0.026	18 x 35	3191	0.025
				18 x 30	3157	0.026			
10000	16 x 35	2740	0.026	18 x 35	3191	0.025	18 x 40	3316	0.020
	18 x 30	3157	0.026						
12000	16 x 40	3408	0.022	18 x 40	3316	0.020			
	18 x 35	3191	0.025						
15000	18 x 35	3191	0.025						
18000	18 x 40	3316	0.020						

Note: 1. Ripple Current: (mA/rms) 105°C, 100KHz

2. ESR: 100KHz / 20°C (Ω)



## CASE SIZE & PERMISSIBLE RIPPLE CURRENT OF STANDARD PRODUCTS

D x L: mm

CAP. (μF)	RATED VOLTAGE WV (SURGE VOLTAGE WV)								
	25 (32) SIZE			35 (44) SIZE			50 (63) SIZE		
	SIZE	RIPPLE	ESR	SIZE	RIPPLE	ESR	SIZE	RIPPLE	ESR
33							6.3 x 11	259	0.390
39							6.3 x 11	259	0.390
47				6.3 x 11	298	0.286	6.3 x 11	259	0.390
56				6.3 x 11	298	0.286	8 x 11	487	0.221
68				6.3 x 11	298	0.286	8 x 11	487	0.221
82	6.3 x 11	298	0.286	8 x 11	561	0.169	8 x 11	487	0.221
100	6.3 x 11	298	0.286	8 x 11	561	0.169	10 x 12	487	0.156
120	8 x 11	561	0.169	8 x 11	561	0.169	8 x 15	667	0.156
							10 x 12	640	0.156
150				8 x 11	561	0.169	10 x 15	667	0.109
180	8 x 11	561	0.169	10 x 12	759	0.104	8 x 15	921	0.118
							10 x 15	798	0.109
220	8 x 11	561	0.169	8 x 15	737	0.113	10 x 19.5	921	0.078
				10 x 12	759	0.104	12 x 15	1070	0.079
270	10 x 12	759	0.104	10 x 15	1061	0.078	10 x 25	1105	0.072
330	8 x 15	737	0.113	8 x 20	921	0.090	10 x 30	1263	0.056
	10 x 12	759	0.104	10 x 15	1061	0.078			
390	10 x 15	1061	0.078	10 x 19.5	1228	0.060	16 x 15	1456	0.072
				12 x 15	1272	0.064			
470	8 x 20	921	0.090	10 x 19.5	1228	0.060	10 x 30	1482	0.056
	10 x 15	1061	0.078				12.5 x 25	1482	0.044
560	10 x 19.5	1228	0.060	10 x 25	1447	0.055	12.5 x 25	1710	0.044
	12.5 x 15	1272	0.064				18 x 15	1710	0.070
680	10 x 19.5	1228	0.060	10 x 30	1482	0.056	12.5 x 30	1693	0.039
				12.5 x 25	1863	0.039	16 x 20	2026	0.044
				16 x 15	1570	0.072			
820	10 x 25	1447	0.055	12.5 x 25	1863	0.039	12.5 x 35	2201	0.033
				18 x 15	1687	0.073	18 x 20	2184	0.047
1000	10 x 30	1675	0.040	12.5 x 25	1920	0.046	12.5 x 35	2561	0.027
	16 x 15	1570	0.072	16 x 20	1938	0.046	16 x 25	2241	0.033
1200	12.5 x 25	1863	0.039	12.5 x 30	2214	0.034	16 x 30	2640	0.029
	18 x 15	1687	0.073	16 x 20	1938	0.046	18 x 25	2403	0.034



## CASE SIZE & PERMISSIBLE RIPPLE CURRENT OF STANDARD PRODUCTS

D x L: mm

CAP. (μF)	RATED VOLTAGE WV (SURGE VOLTAGE WV)								
	25 (32) SIZE			35 (44) SIZE			50 (63) SIZE		
	SIZE	RIPPLE	ESR	SIZE	RIPPLE	ESR	SIZE	RIPPLE	ESR
1500	12.5 x 25	1863	0.039	12.5 x 35	2406	0.029	16 x 35	2763	0.025
	16 x 20	1938	0.046	16 x 25	2238	0.036			
1800	12.5 x 30	2214	0.034	12.5 x 40	2798	0.025	18 x 30	3188	0.027
	16 x 20	1938	0.046	16 x 25	2238	0.036			
2200	12.5 x 35	2406	0.029	16 x 30	2657	0.029	18 x 35	3228	0.022
	18 x 20	2188	0.044	18 x 25	2430	0.031			
2700	16 x 25	2238	0.036	16 x 35	2740	0.026	18 x 40	3333	0.018
				18 x 30	3157	0.026			
3300	16 x 30	2657	0.029	18 x 35	3191	0.025			
	18 x 25	2430	0.031						
3900	16 x 35	2740	0.026	18 x 40	3316	0.020			
	18 x 30	3157	0.026						
4700	18 x 35	3191	0.025						
5600	18 x 40	3316	0.020						

Note: 1. Ripple Current: (mA/rms) 105°C, 100KHz  
 2. ESR: 100KHz / 20°C (Ω)



## CASE SIZE & PERMISSIBLE RIPPLE CURRENT OF STANDARD PRODUCTS

D x L: mm

CAP. (μF)	RATED VOLTAGE WV (SURGE VOLTAGE WV)								
	63 (79)			100 (125)			160 (200)		
	SIZE	RIPPLE	ESR	SIZE	RIPPLE	ESR	SIZE	RIPPLE	ESR
10							10 x 15	219	2.925
15				6.3 x 11	101	1.560			
22	6.3 x 11	101	1.560				10 x 19.5.5	307	1.950
27				8 x 11	203	0.819			
33	6.3 x 11	101	1.560						
39	8 x 11	203	0.819	8 x 15	263	0.585			
47	8 x 11	203	0.819	10 x 12	253	0.559	12.5 x 25	526	0.897
56	8 x 11	203	0.819	8 x 20	317	0.429			
68	8 x 11	203	0.819	10 x 15	313	0.403			
82	10 x 12	253	0.559	10 x 19.5	409	0.273			
				12.5 x 15	409	0.299			
100	8 x 15	263	0.585	10 x 25	466	0.260	16 x 25	798	0.455
	10 x 12	253	0.559						
120	10 x 15	313	0.403	10 x 30	581	0.195			
150	8 x 20	317	0.429	16 x 15	697	0.182			
180	10 x 19.5	409	0.273	12.5 x 25	688	0.156			
	12.5 x 15	409	0.299	18 x 15	807	0.156			
220	10 x 19.5	409	0.273	12.5 x 30	794	0.130	18 x 35	1202	0.273
	10 x 25	466	0.260	16 x 20	912	0.118			
270	16 x 15	697	0.182	12.5 x 35	921	0.108			
				16 x 25	1096	0.095			
330	10 x 30	581	0.195	12.5 x 40	1035	0.092			
				18 x 20	1088	0.104			
390	12.5 x 25	688	0.156	16 x 30	1377	0.070			
	18 x 15	807	0.156	18 x 25	1307	0.074			
470	12.5 x 30	794	0.130	16 x 32	1570	0.059			
	16 x 20	912	0.118	18 x 30	1430	0.061			
560	16 x 25	1096	0.095	18 x 36	1570	0.052			
680	12.5 x 35	921	0.108	18 x 36	1570	0.052			
	16 x 25	1096	0.095						
	18 x 20	1088	0.104						
820	12.5 x 40	1035	0.092	18 x 40	2044	0.047			
	16 x 30	1377	0.070						
	18 x 25	1307	0.074						
1000	16 x 30	1377	0.070						
	16 x 35	1570	0.059						
1200	16 x 40	1772	0.052						
	18 x 30	1430	0.061						
1500	18 x 35	1570	0.052						
1800	18 x 40	2044	0.047						

Note: 1. Ripple Current: (mA/rms) 105°C, 100KHz

2. ESR: 100KHz / 20°C (Ω)

**CASE SIZE & PERMISSIBLE RIPPLE CURRENT OF STANDARD PRODUCTS**

D x L: mm

CAP. (μF)	RATED VOLTAGE WV (SURGE VOLTAGE WV)											
	200 (250)			250 (300)			400 (450)			450 (500)		
	SIZE	RIPPLE	ESR	SIZE	RIPPLE	ESR	SIZE	RIPPLE	ESR	SIZE	RIPPLE	ESR
2.2										10 x 15	96	10.270
3.3							10 x 19.5	171	5.460	10 x 19.5	118	8.060
4.7				10 x 15	145	6.285	10 x 25	193	4.485			
10	10 x 15	219	2.925	10 x 19.5	202	5.200	12.5 x 25	316	2.340	12.5 x 25	228	3.380
22	10 x 19.5	307	1.950	12.5 x 25	316	2.340	16 x 25	500	1.586	16 x 30	421	1.300
33				12.5 x 25	316	2.340	16 x 30	614	0.897	18 x 35	579	0.806
47	12.5 x 25	526	0.897	16 x 25	500	1.105	18 x 30	754	0.650			
100	16 x 30	1017	0.468	18 x 35	820	0.585						
220	18 x 35	1202	0.234	18 x 40	877	0.520						

Note: 1. Ripple Current: (mA/rms) 105°C, 100KHz

2. ESR: 100KHz / 20°C (Ω)

# Miniature Aluminum Electrolytic Capacitors

# SU [ For Higher Temperature Range ]

125°C 2000 Hours, High Temperature

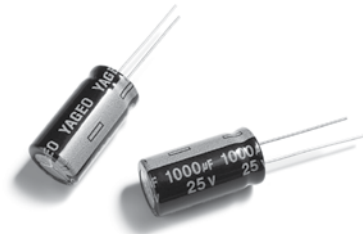

## DESCRIPTION

Applicable for Electronic Ballast, Lighting Ballast

### MULTIPLIER FOR RIPPLE CURRENT

FREQUENCY (Hz)	120	1K	10K	50K~100K
Cap ≤ 10µF	1.00	1.45	1.65	1.70
10µF < Cap ≤ 100µF	1.00	1.36	1.48	1.53
100µF < Cap ≤ 1,000µF	1.00	1.25	1.35	1.38
1,000µF < Cap	1.00	1.17	1.25	1.28

## ELECTRICAL CHARACTERISTICS

Operating Temperature Range : -40 ~ +125°C

Rated Voltage Range : 10 ~ 63VDC

Rated Capacitance Range : 4.7 ~ 4700µF

Capacitance Tolerance : ±20% at 120Hz, 20°C

Leakage Current (Max.) (20°C): I = 0.01CV or 3µA whichever is greater.

(After Rated Voltage Applied for 2 Minutes)

I = Leakage Current (µA), C = Nominal Capacitance (µF), V = Rated Voltage (V)

Dissipation Factor (Max.) (tanδ) (120Hz, 20°C)

WV (V) :	10	16	25	35	50	63
D.F. (%) :	0.20	0.16	0.14	0.12	0.10	0.09

When nominal capacitance is over 1000µF, the value of tanδ shall be increased by 0.02 for every addition of 1000µF.

Low Temperature Stability Impedance Ratio (Max.)

WV (V) :	10	16	25	35	50	63
Z-25°C/Z+20°C :	3	2	2	2	2	2
Z-25°C/Z+20°C :	6	4	4	4	4	4

Endurance: After the rated voltage and rated ripple current have been applied at 125°C for 2000 hours, the capacitors shall meet the following requirements.

- (a) Capacitance Change: Within ±30% of Initial Value
- (b) Dissipation Factor: 300% or Less of Initial Specified Value
- (c) Leakage Current: Initial Specified Value or Less

Shelf Life: After leaving capacitors under no load at 125°C for 1000 hours.

- (a) Capacitance Change: Within ±30% of Initial Value
- (b) Dissipation Factor: 300% or Less of Initial Specified Value
- (c) Leakage Current: 500% or Less of Initial Specified Value

## DIAGRAM OF DIMENSIONS

Dimensions: mm

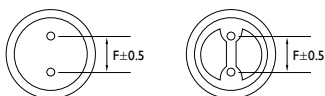

$D\phi < 20$   $D\phi + 0.5$   
 $D\phi \geq 20$   $D\phi + 1$

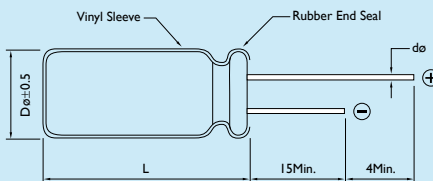

Dφ	F	dφ
5.0	1.5	0.5
6.3		
8.0		0.6
10.0		
13.0	2.0	
16.0		0.8

**CASE SIZE & PERMISSIBLE RIPPLE CURRENT OF STANDARD PRODUCTS**

D x L: mm

CAP. (μF)	RATED VOLTAGE WV (SURGE VOLTAGE WV)											
	10 (13)		16 (20)		25 (32)		35 (44)		50 (63)		63 (79)	
	SIZE	RIPPLE	SIZE	RIPPLE	SIZE	RIPPLE	SIZE	RIPPLE	SIZE	RIPPLE	SIZE	RIPPLE
4.7											5 x 11	92
10									5 x 11	92	6.3 x 11	145
22							5 x 11	92	6.3 x 11	145	8 x 11	210
33					5 x 11	92	6.3 x 11	145	8 x 11	210	10 x 12	300
47			5 x 11	92	6.3 x 11	145	8 x 11	210	10 x 12	300	10 x 15	410
100	5 x 11	92	6.3 x 11	145	8 x 11	210	10 x 12	300	10 x 15	410	10 x 19.5	510
150	6.3 x 11	145	8 x 11	210	10 x 12	300	10 x 15	410	10 x 19.5	510	13 x 20	740
220	8 x 11	210	10 x 12	300	10 x 15	410	10 x 19.5	510	13 x 20	740	13 x 25	1070
330	10 x 12	300	10 x 15	410	10 x 19.5	510	13 x 20	740	13 x 25	1070	16 x 25	1100
470	10 x 15	410	10 x 19.5	510	13 x 20	740	16 x 25	1100	16 x 25	1100	16 x 32	1200
1000	10 x 19.5	510	13 x 20	740	16 x 25	1100	16 x 32	1200	16 x 32	1200		
2200	13 x 25	1070	16 x 25	1100	16 x 32	1200						
3000	16 x 25	1100	16 x 32	1200								
4700	16 x 32	1200										

Note: I. Ripple Current: (mA/rms) 125°C, 120KHz

# Miniature Aluminum Electrolytic Capacitors

# SW [ Higher Temperature Range and Long Life ]

125°C 2000 ~ 5000 Hours, High Temperature Long Life

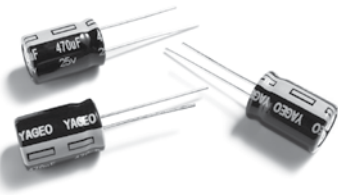

## DESCRIPTION

Applicable for Electronic Ballast, Lighting Ballast

### MULTIPLIER FOR RIPPLE CURRENT

FREQUENCY (Hz)	120	1K	10K	100K
Cap ≤ 10µF	0.40	0.75	0.90	1.00
10µF < Cap ≤ 100µF	0.50	0.85	0.95	1.00
100µF < Cap ≤ 1,000µF	0.60	0.88	0.96	1.00
1,000µF < Cap	0.75	0.90	0.98	1.00

## ELECTRICAL CHARACTERISTICS

Operating Temperature Range : -40 ~ +125°C

Rated Voltage Range : 10 ~ 63VDC

Rated Capacitance Range : 47 ~ 4700µF

Capacitance Tolerance : ±20% at 120Hz, 20°C

Leakage Current (Max.) (20°C): I = 0.01CV or 3µA whichever is greater.  
(After Rated Voltage Applied for 2 Minutes)

I = Leakage Current (µA), C = Nominal Capacitance (µF), V = Rated Voltage (V)

Dissipation Factor (Max.) (tanδ) (120Hz, 20°C)

WV (V) :	10	16	25	35	50	63
D.F. (%) :	20	16	14	12	10	9

When nominal capacitance is over 1000µF, the value of tanδ shall be increased by 0.02 for every addition of 1000µF.

Low Temperature Stability Impedance Ratio (Max.)

WV (V) :	10	16	25	35	50	63
Z-25°C/Z+20°C :	3	2	2	2	2	2
Z-40°C/Z+20°C :	6	4	4	4	4	3

Endurance: After the rated voltage and rated ripple current have been applied at 125°C for 2000~5000 hours, the capacitors shall meet the following requirements.

Dø :	8ø	10ø	≥13ø
Load Life :	2000hrs	3000hrs	5000hrs

- (a) Capacitance Change: Within ±30% of Initial Value
- (b) Dissipation Factor: 300% or Less of Initial Specified Value
- (c) Leakage Current: Initial Specified Value or Less

Shelf Life: After leaving capacitors under no load at 125°C for 1000 hours.

- (a) Capacitance Change: Within ±30% of Initial Value
- (b) Dissipation Factor: 300% or Less of Initial Specified Value
- (c) Leakage Current: 500% or Less of Initial Specified Value

## DIAGRAM OF DIMENSIONS

Dimensions: mm



Dø < 20 Dø + 0.5  
Dø ≥ 20 Dø + 1

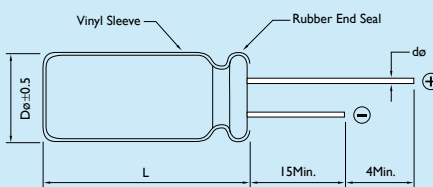

Dø	F	dø
8.0	1.5	0.6
10.0		
13.0	2.0	
16.0		0.8
18.0		

**CASE SIZE & PERMISSIBLE RIPPLE CURRENT OF STANDARD PRODUCTS**

D x L: mm

CAP. (μF)	RATED VOLTAGE WV (SURGE VOLTAGE WV)											
	10 (13)			16 (20)			25 (32)			35 (44)		
	SIZE	RIPPLE	ESR	SIZE	RIPPLE	ESR	SIZE	RIPPLE	ESR	SIZE	RIPPLE	ESR
100							8 x 11	340	0.200	10 x 12	340	0.140
220	8 x 11	340	0.200	8 x 11	340	0.200	10 x 12	500	0.140	10 x 15	500	0.090
330	10 x 12	500	0.140	10 x 12	500	0.140	10 x 15	630	0.090	10 x 19	770	0.070
470	10 x 15	630	0.090	10 x 19	770	0.070	10 x 19	770	0.070	13 x 20	920	0.042
1000	10 x 19	770	0.070	13 x 20	920	0.042	13 x 25	1250	0.038	16 x 25	1380	0.028
2200	13 x 25	1250	0.038	16 x 25	1380	0.028	16 x 32	1450	0.025			
3300	16 x 25	1380	0.028	16 x 32	1450	0.025						
4700	16 x 32	1450	0.025	18 x 32	1720	0.018						

Note: 1. Ripple Current: (mA/rms) 125°C, 100kHz

2. ESR: 100kHz / 20°C (Ω)



## CASE SIZE & PERMISSIBLE RIPPLE CURRENT OF STANDARD PRODUCTS

D x L: mm

CAP. (μF)	RATED VOLTAGE WV (SURGE VOLTAGE WV)					
	50 (63) SIZE			63(79) SIZE		
	SIZE	RIPPLE	ESR	SIZE	RIPPLE	ESR
47	8 x 11	245	0.680	8 x 11	245	0.068
100	10 x 12	415	0.360	10 x 15	455	0.300
220	10 x 19	491	0.180	13 x 20	665	0.120
330	13 x 20	665	0.120	13 x 25	995	0.100
470	13 x 25	995	0.100	16 x 25	1000	0.084
1000	16 x 32	1280	0.078			

Note: 1. Ripple Current: (mA/rms) 125°C, 100KHz

2. ESR: 100KHz / 20°C (Ω)



# LH [ For Miniature ]

For Printed Circuit Board High-Performance Aluminum Electrolytic Power Supply Input and Output Filter Capacitors

## Large Can Aluminum Electrolytic Capacitors

### ELECTRICAL CHARACTERISTICS

Operating Temperature Range	-40 to +85°C	-25 to +85°C																								
Rated Voltage Range	6.3 ~ 100V	160 to 450VDC																								
Rated Capacitance	820 ~ 120000µF	56 ~ 2200µF																								
Capacitance Tolerance	±20% at 120Hz, 20°C																									
Leakage Current	I = 0.02CV or 3mA Whichever is smaller. (After 5 Minutes Application of DC Working Voltage at 20°C)																									
Dissipation Factor (tanδ)	<table border="1"> <tr> <td>Rate Voltage (V)</td> <td>6.3</td> <td>10</td> <td>16</td> <td>25</td> <td>35</td> <td>50</td> <td>63-100</td> <td>160-400</td> <td>450-500</td> </tr> <tr> <td>D.F. (%)</td> <td>60</td> <td>55</td> <td>55</td> <td>45</td> <td>35</td> <td>30</td> <td>25</td> <td>15</td> <td>20</td> </tr> </table>		Rate Voltage (V)	6.3	10	16	25	35	50	63-100	160-400	450-500	D.F. (%)	60	55	55	45	35	30	25	15	20				
Rate Voltage (V)	6.3	10	16	25	35	50	63-100	160-400	450-500																	
D.F. (%)	60	55	55	45	35	30	25	15	20																	
Low Temperature Stability	Measurement frequency: 120Hz																									
Impedance Ratio (Max.)	<table border="1"> <tr> <td>Rate Voltage (V)</td> <td>6.3~16</td> <td>25</td> <td>35</td> <td>50~63</td> <td>80~10</td> <td>160~400</td> <td>450</td> </tr> <tr> <td>Z(-25°C) / Z(20°C)</td> <td>3</td> <td>3</td> <td>3</td> <td>2</td> <td>2</td> <td>4</td> <td>8</td> </tr> <tr> <td>Z(-40°C) / Z(20°C)</td> <td>12</td> <td>10</td> <td>8</td> <td>6</td> <td>5</td> <td>-</td> <td>-</td> </tr> </table>		Rate Voltage (V)	6.3~16	25	35	50~63	80~10	160~400	450	Z(-25°C) / Z(20°C)	3	3	3	2	2	4	8	Z(-40°C) / Z(20°C)	12	10	8	6	5	-	-
Rate Voltage (V)	6.3~16	25	35	50~63	80~10	160~400	450																			
Z(-25°C) / Z(20°C)	3	3	3	2	2	4	8																			
Z(-40°C) / Z(20°C)	12	10	8	6	5	-	-																			
Endurance	After the rated voltage and rated ripple current have been applied at 85°C for 2000 hours, the capacitors shall meet the following requirements. (a) Capacitance Change: Within 20% of the Initial Value (b) Dissipation Factor: 200% or Less of Initial Specified Value (c) Leakage Current: Initial Specified Value or Less																									
Shelf Life	After having been placed at 85°C without voltage applied for 1000 hours, the capacitors shall meet the same requirements as Endurance.																									

### DIAGRAM OF DIMENSIONS

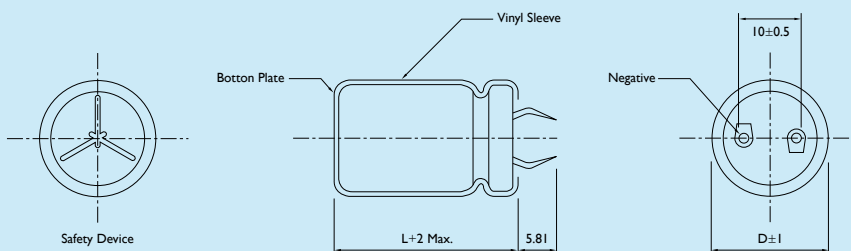

### DESCRIPTION

Endurance : 85°C, 2000 Hours

Ideally suitable for using in switching power supplies and other industrial / commercial applications

### MULTIPLIER FOR RIPPLE CURRENT

Frequency Coefficient

FREQUENCY (Hz)	50	60	120	1K	10K
6.3~100V	0.88	0.90	1.00	1.15	1.16
160~250V	0.75	0.78	1.00	1.16	1.23
350~450V	0.74	0.76	1.00	1.10	1.15
500V	0.72	0.74	1.00	1.05	1.10

Unit: mm

Location of P.C.B. Holes

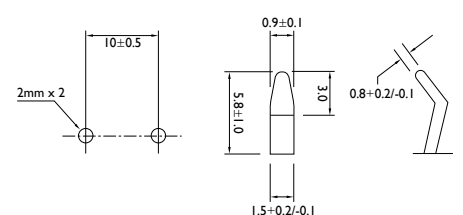



## CASE SIZE & PERMISSIBLE RIPPLE CURRENT OF STANDARD PRODUCTS

D × L: mm

CAP. (μF)	RATED VOLTAGE WV (SURGE VOLTAGE WV)							
	6.3 (8) SIZE		10 (13) SIZE		16 (20) SIZE		25 (32) SIZE	
		RIPPLE		RIPPLE		RIPPLE		RIPPLE
5600							22 × 25	2.20
6800							22 × 30	2.40
							25 × 25	2.45
8200					22 × 25	2.60	22 × 35	2.70
							25 × 25	2.75
10000					22 × 30	2.70	22 × 40	3.10
					25 × 25	2.75	25 × 30	3.15
							30 × 25	3.20
12000			22 × 25	2.40	22 × 30	2.90	22 × 45	3.50
					25 × 25	2.95	25 × 35	3.45
							30 × 30	3.50
							35 × 25	3.55
15000	22 × 25	2.44	22 × 30	2.75	22 × 35	3.30	22 × 50	4.00
			25 × 25	2.75	25 × 30	3.45	25 × 40	3.95
					30 × 25	3.50	30 × 35	4.00
							35 × 30	4.05
18000	22 × 30	2.60	22 × 35	3.15	22 × 40	3.70	25 × 45	4.45
	25 × 25	2.62	25 × 25	3.05	25 × 35	3.75	30 × 35	4.45
					30 × 30	3.80	35 × 30	4.60
22000	22 × 30	3.06	22 × 40	3.55	22 × 50	4.35	30 × 40	5.20
	25 × 25	3.07	25 × 30	3.50	25 × 40	4.30	35 × 35	5.15
			30 × 25	3.55	30 × 30	4.25	30 × 45	5.95
					35 × 25	4.20	35 × 40	5.90
27000	22 × 35	3.49	22 × 45	4.05	25 × 45	4.70	30 × 50	6.70
	25 × 30	3.52	25 × 35	4.00	30 × 35	4.65	35 × 45	6.75
	30 × 25	3.57	30 × 30	4.05	35 × 30	4.65		
33000	22 × 40	3.97	22 × 50	4.60	30 × 40	5.35	35 × 50	7.55
	25 × 35	4.02	25 × 40	4.55	35 × 30	5.40		
	30 × 30	4.05	30 × 30	4.50				
	35 × 25	4.10	35 × 25	4.50				

Note: I. Ripple Current: (A/rms) 85°C, 120Hz

**CASE SIZE & PERMISSIBLE RIPPLE CURRENT OF STANDARD PRODUCTS**

D x L: mm

CAP. (μF)	RATED VOLTAGE WV (SURGE VOLTAGE WV)							
	6.3 (8) SIZE		10 (13) SIZE		16 (20) SIZE		25 (32) SIZE	
		RIPPLE		RIPPLE		RIPPLE		RIPPLE
39000	22 x 50	4.56	25 x 45	5.10	30 x 45	6.00		
	25 x 40	4.50	30 x 35	5.05	35 x 35	5.95		
	30 x 30	4.46	35 x 30	5.05				
	35 x 25	4.51						
47000	25 x 45	5.09	25 x 50	5.75	30 x 50	6.80		
	30 x 35	5.06	30 x 40	5.70	35 x 40	6.75		
	35 x 30	5.03	35 x 30	5.65				
56000	25 x 50	5.71	30 x 45	6.45	35 x 45	7.60		
	30 x 40	5.70	35 x 35	6.40				
	35 x 30	5.75						
68000	30 x 45	6.48	30 x 50	7.05	35 x 50	8.00		
	35 x 35	6.42	35 x 40	7.10				
82000	30 x 50	7.32	35 x 50	7.50				
	35 x 40	7.29						
100000	35 x 45	8.31						
120000	35 x 50	8.60						

Note: I. Ripple Current: (A/rms) 85°C, 120Hz



## CASE SIZE & PERMISSIBLE RIPPLE CURRENT OF STANDARD PRODUCTS

D × L: mm

CAP. (μF)	RATED VOLTAGE WV (SURGE VOLTAGE WV)							
	35 (44) SIZE		50 (63) SIZE		63 (79) SIZE		80 (100) SIZE	
		RIPPLE		RIPPLE		RIPPLE		RIPPLE
1200							22 × 25	1.65
1500							22 × 30	1.90
							25 × 25	1.90
1800					22 × 25	1.85	22 × 35	2.20
							25 × 30	2.20
							30 × 25	2.20
2200			22 × 25	1.90	22 × 30	2.30	22 × 40	2.45
					25 × 25	2.30	25 × 30	2.45
							30 × 25	2.50
2700			22 × 30	2.10	22 × 35	2.45	22 × 45	2.80
			25 × 25	2.20	25 × 30	2.45	25 × 35	2.80
					30 × 25	2.50	30 × 30	2.85
							35 × 25	2.85
3300			22 × 30	2.35	22 × 40	2.60	22 × 50	3.15
			25 × 25	2.35	25 × 30	2.65	25 × 40	3.20
					30 × 25	2.70	30 × 30	3.20
							35 × 25	3.20
3900	22 × 25	2.20	22 × 35	2.65	22 × 45	2.95	25 × 45	3.60
			25 × 30	2.65	25 × 35	2.95	30 × 35	3.60
			30 × 25	2.65	30 × 30	3.00	35 × 30	3.60
4700	22 × 30	2.40	22 × 40	3.00	22 × 50	3.40	25 × 50	4.05
	25 × 25	2.40	25 × 35	3.00	25 × 40	3.35	30 × 40	4.05
			30 × 25	2.95	30 × 30	3.35	35 × 35	4.10
					35 × 25	3.40		
5600	22 × 35	2.75	22 × 45	3.35	25 × 45	3.70	30 × 45	4.55
	25 × 25	2.75	25 × 40	3.35	30 × 35	3.75	35 × 35	4.50
			30 × 30	3.35	35 × 30	3.75		
			35 × 25	3.40				

Note: I. Ripple Current: (A/rms) 85°C, 120Hz

**CASE SIZE & PERMISSIBLE RIPPLE CURRENT OF STANDARD PRODUCTS**

D x L: mm

CAP. (μF)	RATED VOLTAGE WV (SURGE VOLTAGE WV)							
	35 (44) SIZE		50 (63) SIZE		63 (79) SIZE		80 (100) SIZE	
		RIPPLE		RIPPLE		RIPPLE		RIPPLE
6800	22 x 40	2.85	22 x 50	3.80	30 x 40	4.25	30 x 50	5.15
	25 x 30	2.85	25 x 40	3.80	35 x 30	4.20	35 x 40	5.15
	30 x 25	2.90	30 x 30	3.80				
			30 x 35	3.85				
			35 x 30	3.85				
8200	22 x 45	3.15	25 x 50	4.35	30 x 45	4.80	35 x 45	5.85
	25 x 35	3.10	30 x 40	4.35	35 x 35	4.80		
	30 x 30	3.15	35 x 30	4.40				
10000	22 x 50	3.55	30 x 45	5.00	30 x 50	5.50	35 x 50	6.60
	25 x 40	3.50	35 x 35	4.95	35 x 40	5.45		
	30 x 30	3.45						
	35 x 25	3.40						
12000	25 x 45	3.95	30 x 50	5.60	35 x 45	6.20		
	30 x 35	4.00	35 x 40	5.55				
	35 x 30	4.05						
15000	25 x 50	4.95	35 x 45	6.45				
	30 x 40	4.95						
	35 x 35	5.00						
18000	30 x 45	5.50	35 x 50	6.70				
	35 x 40	5.55						
22000	30 x 50	6.00						
	35 x 45	6.05						
27000	35 x 50	6.90						

Note: I. Ripple Current: (A/rms) 85°C, 120Hz



## CASE SIZE & PERMISSIBLE RIPPLE CURRENT OF STANDARD PRODUCTS

D × L: mm

CAP. (μF)	RATED VOLTAGE WV (SURGE VOLTAGE WV)							
	100 (125) SIZE		160 (200) SIZE		180 (225) SIZE		200 (250) SIZE	
		RIPPLE		RIPPLE		RIPPLE		RIPPLE
180					22 × 20	1.00	22 × 25	0.95
220					22 × 25	1.10	22 × 25	1.10
270			22 × 25	1.15	22 × 25	1.25	22 × 25	1.25
					25 × 20	1.25	22 × 30	1.25
							25 × 25	1.25
330			22 × 25	1.40	22 × 25	1.40	22 × 25	1.45
			25 × 20	1.35	22 × 30	1.40	22 × 30	1.45
					25 × 25	1.40	25 × 25	1.45
390			22 × 30	1.55	22 × 30	1.60	22 × 30	1.60
			25 × 25	1.55	25 × 25	1.60	25 × 25	1.55
			30 × 25	1.50				
470			22 × 30	1.75	22 × 35	1.80	22 × 35	1.80
			25 × 25	1.75	25 × 30	1.80	25 × 30	1.80
			30 × 25	1.70	30 × 25	1.80	30 × 25	1.80
560			22 × 30	1.95	22 × 35	2.00	22 × 40	2.00
			25 × 30	1.95	22 × 40	2.00	25 × 35	2.00
			30 × 25	1.90	25 × 30	1.95	30 × 25	2.00
					30 × 25	2.00		
680			22 × 40	2.20	22 × 45	2.25	22 × 45	2.35
			25 × 30	2.20	25 × 35	2.20	25 × 35	2.30
			30 × 25	2.15	30 × 30	2.20	30 × 30	2.30
					35 × 25	2.20	35 × 25	2.30
820	22 × 25	1.85	22 × 45	2.50	22 × 50	2.55	25 × 40	2.60
			25 × 35	2.55	25 × 40	2.55	25 × 45	2.60
			30 × 30	2.50	30 × 30	2.60	30 × 30	2.60
			35 × 25	2.50	30 × 35	2.60	30 × 35	2.60
					35 × 25	2.60	35 × 30	2.60
1000	22 × 30	2.10	22 × 50	2.85	25 × 45	2.85	25 × 45	3.00
	25 × 25	2.10	25 × 40	2.80	30 × 35	2.85	25 × 50	3.00
			30 × 35	2.80	35 × 30	2.90	30 × 35	3.05
			35 × 25	2.80			30 × 40	3.05
							35 × 30	3.00

Note: I. Ripple Current: (A/rms) 85°C, 120Hz

**CASE SIZE & PERMISSIBLE RIPPLE CURRENT OF STANDARD PRODUCTS**

D x L: mm

CAP. (μF)	RATED VOLTAGE WV (SURGE VOLTAGE WV)							
	100 (125) SIZE		160 (200) SIZE		180 (225) SIZE		200 (250) SIZE	
		RIPPLE		RIPPLE		RIPPLE		RIPPLE
1200	22 x 35	2.40	25 x 45	3.15	30 x 40	3.25	25 x 50	3.30
	25 x 30	2.45	30 x 35	3.15	35 x 30	3.30	30 x 40	3.30
			35 x 30	3.20	35 x 35	3.30	30 x 45	3.30
							35 x 30	3.30
							35 x 35	3.30
1500	22 x 40	2.70	30 x 45	3.75	30 x 45	3.85	30 x 45	3.80
	25 x 30	2.75	35 x 30	3.70	35 x 35	3.80	30 x 50	3.80
	30 x 25	2.75	35 x 35	3.70	35 x 40	3.80	35 x 35	3.80
							35 x 40	3.80
1800	22 x 45	3.10	30 x 50	4.20	35 x 40	4.30	35 x 40	4.35
	25 x 35	3.15	35 x 40	4.20	35 x 45	4.30	35 x 45	4.35
	30 x 30	3.15						
	35 x 25	3.15						
2200	22 x 50	3.50	35 x 40	4.60	35 x 45	4.90	35 x 45	4.95
	25 x 40	3.55	35 x 45	4.80	35 x 50	4.90	35 x 50	4.95
	30 x 30	3.55						
	35 x 25	3.60						
2700	25 x 45	4.10	35 x 50	5.45				
	30 x 35	4.05						
	35 x 30	4.05						
3300	25 x 50	4.50						
	30 x 40	4.55						
	35 x 30	4.50						
3900	30 x 45	5.15						
	35 x 35	5.10						
4700	35 x 40	5.75						
5600	35 x 50	6.20						

Note: I. Ripple Current: (A/rms) 85°C, 120Hz



## CASE SIZE & PERMISSIBLE RIPPLE CURRENT OF STANDARD PRODUCTS

D × L: mm

CAP. (μF)	RATED VOLTAGE WV (SURGE VOLTAGE WV)											
	250 (300) SIZE    RIPPLE		350 (400) SIZE    RIPPLE		400 (450) SIZE    RIPPLE		420 (470) SIZE    RIPPLE		450 (500) SIZE    RIPPLE		500 (550) SIZE    RIPPLE	
47									22 × 25	0.50		
56					22 × 20	0.55			22 × 25	0.65		
68			22 × 20	0.55	22 × 25	0.60			22 × 25	0.67		
					25 × 20	0.60			22 × 30	0.70		
									25 × 25	0.70		
82			22 × 25	0.65	22 × 25	0.80			22 × 30	0.80		
			25 × 20	0.65	25 × 20	0.80			25 × 25	0.80		
100			22 × 30	0.90	22 × 30	0.90			22 × 30	0.85	22 × 40	1.00
			25 × 20	0.90	25 × 25	0.90			22 × 35	0.95	30 × 25	0.90
									25 × 30	0.95		
									30 × 25	0.95		
120	22 × 20	0.78	22 × 30	1.00	22 × 30	0.95	22 × 30	0.95	22 × 30	0.95	30 × 30	1.00
			25 × 25	1.00	22 × 35	1.05			22 × 40	1.05	35 × 25	1.00
					25 × 25	1.05			25 × 30	1.05		
									30 × 25	1.05		
150	22 × 25	0.90	22 × 35	1.15	22 × 35	1.15	22 × 35	1.05	22 × 35	1.05	22 × 50	1.40
			25 × 30	1.15	25 × 30	1.15	25 × 30	1.05	22 × 45	1.20	30 × 35	1.20
			30 × 25	1.15	30 × 25	1.15	30 × 25	1.05	25 × 35	1.20		
									30 × 30	1.20		
180	22 × 25	1.05	22 × 40	1.30	22 × 40	1.20	22 × 40	1.35	25 × 40	1.35	30 × 40	1.40
	25 × 20	1.00	25 × 30	1.25	22 × 45	1.30			30 × 35	1.35	35 × 30	1.30
			30 × 25	1.25	25 × 35	1.30			35 × 25	1.35		
					30 × 30	1.35						
220	22 × 30	1.15	22 × 45	1.45	22 × 50	1.50	22 × 45	1.40	22 × 45	1.40	30 × 45	1.60
	22 × 35	1.15	25 × 35	1.45	25 × 40	1.50	22 × 50	1.55	25 × 50	1.55	35 × 35	1.50
	25 × 25	1.15	30 × 30	1.45	30 × 30	1.50	25 × 40	1.50	30 × 40	1.55		
			35 × 25	1.45	35 × 25	1.50	25 × 45	1.60	35 × 30	1.55		
270	22 × 30	1.30	25 × 40	1.65	22 × 50	1.60	25 × 40	1.50	25 × 50	1.55	30 × 50	1.80
	25 × 25	1.30	30 × 35	1.65	25 × 40	1.65	30 × 40	1.60	30 × 45	1.75	35 × 40	1.70
			35 × 25	1.65	30 × 35	1.65			35 × 35	1.70		
					35 × 30	1.65						

Note: I. Ripple Current: (A/rms) 85°C, 120Hz



**CASE SIZE & PERMISSIBLE RIPPLE CURRENT OF STANDARD PRODUCTS**

D x L: mm

CAP. (μF)	RATED VOLTAGE WV (SURGE VOLTAGE WV)											
	250 (300)		350 (400)		400 (450)		420 (470)		450 (500)		500 (550)	
	SIZE	RIPPLE	SIZE	RIPPLE	SIZE	RIPPLE	SIZE	RIPPLE	SIZE	RIPPLE	SIZE	RIPPLE
330	22 x 30	1.50	25 x 50	1.80	25 x 45	1.75	25 x 45	1.75	30 x 40	1.75	35 x 45	2.00
	25 x 25	1.50	30 x 40	1.80	25 x 50	1.90	25 x 50	1.85	30 x 50	2.00		
	30 x 25	1.50	35 x 30	1.80	30 x 40	1.90	30 x 40	1.75	35 x 40	2.00		
					35 x 30	1.85	30 x 45	1.90				
390	22 x 35	1.65	30 x 40	2.00	30 x 40	1.95	35 x 45	1.90	30 x 45	2.00	35 x 50	2.30
	25 x 35	1.65	35 x 30	2.00	30 x 45	2.15			35 x 45	2.25		
	30 x 25	1.65			35 x 35	2.10						
470	22 x 40	1.85	30 x 45	2.25	30 x 45	2.20	30 x 45	2.10	30 x 50	2.30		
	25 x 35	1.85	35 x 35	2.25	30 x 50	2.40	30 x 50	2.20	35 x 50	2.50		
	30 x 30	1.90	35 x 40	2.40	35 x 40	2.40						
	35 x 25	1.90										
560	22 x 45	2.10	30 x 50	2.45	30 x 50	2.45	30 x 50	2.30	35 x 50	2.70		
	25 x 40	2.10	35 x 40	2.50	35 x 45	2.70	35 x 45	2.30				
	30 x 30	2.10										
	35 x 25	2.10										
680	25 x 45	2.45	35 x 45	2.90	35 x 50	2.90			35 x 60	2.90		
	30 x 35	2.45										
	35 x 25	2.45										
820	30 x 45	2.75										
	35 x 30	2.75										
1000	30 x 45	3.30										
	35 x 35	3.30										
1200	35 x 40	3.55										
1500	35 x 45	4.05										

Note: I. Ripple Current: (A/rms) 85°C, 120Hz

# Large Can Aluminum Electrolytic Capacitors

# LG [ For General ]

For Printed Circuit Board High-Performance Aluminum Electrolytic Power Supply Input and Output Filter Capacitors



## DESCRIPTION

Endurance : 105°C 2000 hours, higher temperature than LH.

Ideally suitable for using in switching power supplies and other industrial / commercial applications.

### MULTIPLIER FOR RIPPLE CURRENT

Frequency Coefficient

FREQUENCY (Hz)	50	60	120	1K	10K
6.3~100V	0.88	0.90	1.00	1.15	1.16
160~250V	0.85	0.88	1.00	1.15	1.20
315~450V	0.88	0.90	1.00	1.10	1.15

## ELECTRICAL CHARACTERISTICS

Operating Temperature Range	-40 to +105°C	-25 to +105°C																								
Rated Voltage Range	6.3 to 100VDC	160 to 450VDC																								
Rated Capacitance Range	560 ~ 82000µF	47 ~ 2200µF																								
Capacitance Tolerance	±20% at 120Hz, 20°C																									
Leakage Current	I = 0.02CV, L = 20m/m, I = 0.03CV or 3mA whichever is smaller. (After 5 Minutes Application of DC Working Voltage at 20°C) I = Leakage Current (µA), C = Nominal Capacitance (µF), V = Rated Voltage (V)																									
Dissipation Factor (tanδ)	<table border="1"> <thead> <tr> <th>Rate Voltage (V)</th> <th>6.3</th> <th>10</th> <th>16</th> <th>25</th> <th>35</th> <th>50</th> <th>63-100</th> <th>160-400</th> <th>450</th> </tr> </thead> <tbody> <tr> <td>D.F. (%)</td> <td>60</td> <td>55</td> <td>55</td> <td>45</td> <td>35</td> <td>30</td> <td>25</td> <td>15</td> <td>20</td> </tr> </tbody> </table>		Rate Voltage (V)	6.3	10	16	25	35	50	63-100	160-400	450	D.F. (%)	60	55	55	45	35	30	25	15	20				
Rate Voltage (V)	6.3	10	16	25	35	50	63-100	160-400	450																	
D.F. (%)	60	55	55	45	35	30	25	15	20																	
Low Temperature Stability	Measurement frequency: 120Hz																									
Impedance Ratio (Max.)	<table border="1"> <thead> <tr> <th>Rated Voltage (V)</th> <th>6.3~16</th> <th>25</th> <th>35</th> <th>50~63</th> <th>80~10</th> <th>160~400</th> <th>450</th> </tr> </thead> <tbody> <tr> <td>Z(-25°C) / Z(20°C)</td> <td>4</td> <td>3</td> <td>3</td> <td>2</td> <td>2</td> <td>4</td> <td>8</td> </tr> <tr> <td>Z(-40°C) / Z(20°C)</td> <td>15</td> <td>10</td> <td>8</td> <td>6</td> <td>5</td> <td>-</td> <td>-</td> </tr> </tbody> </table>		Rated Voltage (V)	6.3~16	25	35	50~63	80~10	160~400	450	Z(-25°C) / Z(20°C)	4	3	3	2	2	4	8	Z(-40°C) / Z(20°C)	15	10	8	6	5	-	-
Rated Voltage (V)	6.3~16	25	35	50~63	80~10	160~400	450																			
Z(-25°C) / Z(20°C)	4	3	3	2	2	4	8																			
Z(-40°C) / Z(20°C)	15	10	8	6	5	-	-																			
Endurance	After the rated voltage and rated ripple current have been applied at 105°C for 2000 hours, the capacitors shall meet the following requirements. (a) Capacitance Change: ≤ ±20% of the Initial Value (b) Dissipation Factor: ≤ 200% of the Initial Specified Value (c) Leakage Current: ≤ the Initial Specified Value																									
Shelf Life	After having been placed at 105°C without voltage applied for 1000 hours, the capacitors shall meet the same requirements as Endurance.																									

## DIAGRAM OF DIMENSIONS

Unit: mm

Location of P.C.B. Holes

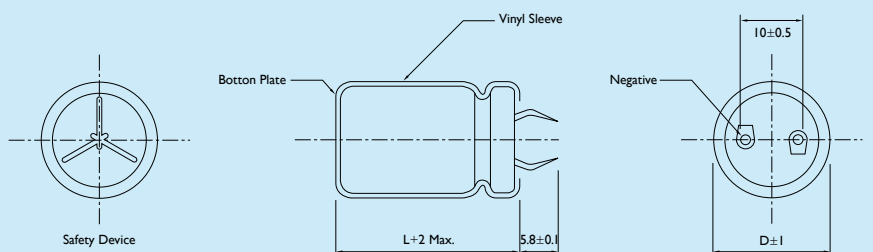
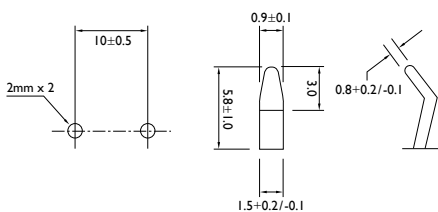

## CASE SIZE & PERMISSIBLE RIPPLE CURRENT OF STANDARD PRODUCTS

D x L: mm

CAP. (μF)	RATED VOLTAGE WV (SURGE VOLTAGE WV)							
	6.3 (8) SIZE		10 (13) SIZE		16 (20) SIZE		25 (32) SIZE	
	SIZE	RIPPLE	SIZE	RIPPLE	SIZE	RIPPLE	SIZE	RIPPLE
4700							22 x 25	1.50
5600							22 x 30	1.65
							25 x 25	1.65
6800					22 x 25	1.55	22 x 30	1.85
							25 x 25	1.85
8200					22 x 30	1.70	22 x 35	2.10
					25 x 25	1.70	25 x 30	2.10
							30 x 25	2.15
10000			22 x 25	1.55	22 x 30	1.95	22 x 40	2.40
			25 x 25	1.55	25 x 25	1.95	25 x 35	2.40
							30 x 30	2.40
							35 x 25	2.40
12000	22 x 25	1.55	22 x 30	1.75	22 x 35	2.20	22 x 45	2.70
					25 x 30	2.25	25 x 40	2.75
					30 x 25	2.30	30 x 30	2.70
							35 x 25	2.75
15000	22 x 30	1.70	22 x 30	1.90	22 x 40	2.55	25 x 45	3.15
	25 x 25	1.70	25 x 25	1.90	25 x 35	2.60	30 x 35	3.15
					30 x 30	2.60	35 x 30	3.25
					35 x 25	2.65		
18000	22 x 30	1.95	22 x 35	2.20	22 x 45	2.90	25 x 50	3.55
	25 x 25	1.95	25 x 30	2.25	25 x 40	2.90	30 x 40	3.55
					30 x 30	2.90	35 x 35	3.55
					35 x 25	2.95		
22000	22 x 35	2.25	22 x 40	2.50	25 x 45	3.30	30 x 45	4.05
	25 x 30	2.25	25 x 35	2.55	30 x 35	3.30	35 x 35	3.80
	30 x 25	2.25	30 x 25	2.45	35 x 30	3.30		
27000	22 x 40	2.55	22 x 50	2.95	25 x 50	3.80	35 x 45	4.70
	25 x 35	2.55	25 x 40	2.90	30 x 40	3.75		
	30 x 30	2.55	30 x 30	2.85	35 x 30	3.75		
	35 x 25	2.55	35 x 25	2.80				
33000	22 x 45	2.90	25 x 45	3.30	30 x 45	4.30	35 x 50	5.40
	25 x 40	2.95	30 x 35	3.30	35 x 35	4.25		
	30 x 30	2.90	35 x 30	3.30				
	35 x 25	2.95						
39000	25 x 50	3.25	25 x 50	3.70	30 x 50	4.80		
	30 x 35	3.25	30 x 40	3.70	35 x 40	4.80		
	35 x 30	3.30	35 x 30	3.65				
47000	25 x 50	3.70	30 x 45	4.20	35 x 45	5.45		
	30 x 40	3.70	35 x 35	3.80				
56000	30 x 45	4.15	30 x 50	4.65				
	35 x 35	4.10	35 x 40	4.65				
68000	30 x 50	4.70	35 x 50	5.50				
	35 x 40	4.70						
82000	35 x 45	5.30						

Note: I. Ripple Current: (A/rms) 105°C, 120Hz



## CASE SIZE & PERMISSIBLE RIPPLE CURRENT OF STANDARD PRODUCTS

D x L: mm

CAP. (μF)	RATED VOLTAGE WV (SURGE VOLTAGE WV)							
	35 (44) SIZE		50 (63) SIZE		63 (79) SIZE		80 (100) SIZE	
		RIPPLE		RIPPLE		RIPPLE		RIPPLE
820							22 x 25	1.10
1000							22 x 30	1.20
							25 x 25	1.20
1200					22 x 25	1.20	22 x 30	1.40
							25 x 25	1.40
1500					22 x 30	1.30	22 x 35	1.60
					25 x 25	1.30	25 x 30	1.60
							30 x 25	1.65
1800			22 x 25	1.30	22 x 30	1.50	22 x 40	1.80
					25 x 25	1.50	25 x 35	1.85
							30 x 25	1.80
2200			22 x 30	1.55	22 x 35	1.70	22 x 45	2.05
			25 x 25	1.55	25 x 30	1.75	25 x 35	2.00
					30 x 25	1.80	30 x 30	2.05
							35 x 25	2.05
2700			22 x 30	1.70	22 x 40	2.00	25 x 45	2.35
			25 x 25	1.70	25 x 35	2.00	30 x 35	2.35
					30 x 25	1.95	35 x 30	2.35
3300	22 x 25	1.40	22 x 35	1.95	22 x 50	2.30	25 x 50	2.70
			25 x 30	1.85	25 x 40	2.30	30 x 40	2.70
					30 x 30	2.25	35 x 30	2.55
					35 x 25	2.10		
3900	22 x 30	1.55	22 x 40	2.15	25 x 45	2.55	30 x 45	3.00
	25 x 25	1.55	25 x 35	2.20	30 x 35	2.55	35 x 35	3.00
			30 x 25	1.95	35 x 30	2.55		
4700	22 x 35	1.80	22 x 45	2.45	25 x 50	2.85	30 x 50	3.40
	25 x 25	1.80	25 x 40	2.45	30 x 40	2.85	35 x 40	3.40
			30 x 30	2.45	35 x 30	2.80		
			35 x 25	2.50				

Note: I. Ripple Current: (A/rms) 105°C, 120Hz

**CASE SIZE & PERMISSIBLE RIPPLE CURRENT OF STANDARD PRODUCTS**

D x L: mm

CAP. (μF)	RATED VOLTAGE WV (SURGE VOLTAGE WV)							
	35 (44) SIZE		50 (63) SIZE		63 (79) SIZE		80 (100) SIZE	
		RIPPLE		RIPPLE		RIPPLE		RIPPLE
5600	22 x 35	19.5	22 x 50	2.75	30 x 45	3.20	35 x 45	3.80
	25 x 30	1.95	25 x 40	2.70	35 x 35	3.20		
	30 x 25	2.00	30 x 35	2.75				
			35 x 30	2.75				
6800	22 x 40	2.20	25 x 50	3.30	30 x 50	3.65	35 x 50	3.90
	25 x 35	2.25	30 x 40	3.30	35 x 40	3.65		
	30 x 30	2.30	35 x 30	3.25				
	35 x 25	2.35						
8200	22 x 50	2.55	30 x 45	3.60	35 x 45	3.90	35 x 60	4.00
	25 x 40	2.50	35 x 35	3.55				
	30 x 30	2.75						
	35 x 25	2.75						
10000	25 x 45	2.85	30 x 50	4.05	35 x 50	4.40		
	30 x 35	2.90	35 x 50	4.05				
	35 x 30	2.95	35 x 40	4.00				
12000	25 x 50	3.25	35 x 45	4.55				
	30 x 40	3.25						
	35 x 30	3.15						
15000	30 x 45	3.70						
	35 x 35	3.65						
18000	35 x 40	4.35						
22000	35 x 50	4.90						

Note: I. Ripple Current: (A/rms) 105°C, 120Hz



## CASE SIZE & PERMISSIBLE RIPPLE CURRENT OF STANDARD PRODUCTS

D × L: mm

CAP. (μF)	RATED VOLTAGE WV (SURGE VOLTAGE WV)							
	100 (125) SIZE		160 (200) SIZE		180 (225) SIZE		200 (250) SIZE	
		RIPPLE		RIPPLE		RIPPLE		RIPPLE
150							22 × 20	0.65
180					22 × 20	0.75	22 × 20	0.70
220			22 × 20	0.80	22 × 25	0.85	22 × 25 25 × 20	0.80 0.80
270			22 × 25	1.00	22 × 25 25 × 20	0.95 0.90	22 × 25 25 × 25	0.85 0.85
330			22 × 25 25 × 20	1.20 1.15	22 × 25 22 × 30 25 × 25	1.20 1.10 1.10	22 × 30 25 × 25	1.20 1.20
390			22 × 30 25 × 25	1.30 1.30	22 × 30 25 × 25	1.30 1.30	22 × 30 22 × 35 25 × 30 30 × 25	1.30 1.30 1.30 1.30
470			22 × 30 22 × 35 25 × 25	1.30 1.40 1.40	22 × 30 22 × 35 25 × 30 30 × 25	1.30 1.35 1.40 1.40	22 × 35 22 × 40 25 × 30 30 × 25	1.40 1.40 1.40 1.50
560	22 × 25	1.05	22 × 40 25 × 30 30 × 25	1.50 1.50 1.50	22 × 40 25 × 35 30 × 25	1.50 1.55 1.50	22 × 45 25 × 35 30 × 30	1.55 1.55 1.55
680	22 × 25	1.20	22 × 45 25 × 35 30 × 25	1.70 1.70 1.70	22 × 45 22 × 50 25 × 35 25 × 40 30 × 30 35 × 25	1.70 1.70 1.70 1.75 1.70 1.70	22 × 50 25 × 40 30 × 30 35 × 25	1.75 1.75 1.75 1.70
820	22 × 30 25 × 25	1.30 1.33	22 × 50 25 × 40 30 × 30 35 × 25	1.95 2.00 2.00 1.90	22 × 50 25 × 40 25 × 45 30 × 35 35 × 25	1.95 2.00 2.00 2.00 1.90	25 × 50 30 × 35 35 × 30	2.05 2.00 2.05

Note: I<sub>r</sub> Ripple Current: (A/rms) 105°C, 120Hz

## CASE SIZE & PERMISSIBLE RIPPLE CURRENT OF STANDARD PRODUCTS

D x L: mm

CAP. (μF)	RATED VOLTAGE WV (SURGE VOLTAGE WV)							
	100 (125) SIZE		160 (200) SIZE		180 (225) SIZE		200 (250) SIZE	
		RIPPLE		RIPPLE		RIPPLE		RIPPLE
1000	22 x 35	1.50	25 x 45	2.20	25 x 45	2.20	30 x 40	2.30
	25 x 30	1.50	30 x 35	2.20	25 x 50	2.20	30 x 45	2.30
			35 x 30	2.20	30 x 35	2.25	35 x 30	2.30
					30 x 40	2.25	35 x 35	2.30
					35 x 30	2.25		
1200	22 x 40	1.70	25 x 50	2.45	25 x 50	2.45	30 x 50	2.60
	25 x 35	1.70	30 x 40	2.45	30 x 40	2.45	35 x 40	2.65
	30 x 25	1.70	35 x 30	2.45	30 x 45	2.50		
					35 x 35	2.50		
1500	22 x 45	1.95	30 x 45	2.80	30 x 45	2.80	35 x 45	3.10
	25 x 40	2.00	35 x 35	2.80	30 x 50	2.90		
	30 x 30	1.95			35 x 40	2.90		
	35 x 25	2.00						
1800	25 x 45	2.20	30 x 50	3.30	30 x 50	3.30	35 x 50	3.15
	30 x 35	2.50	35 x 45	3.30	35 x 50	3.30		
	35 x 30	2.45						
2200	25 x 50	2.55	35 x 50	3.75	35 x 50	3.60	35 x 50	4.80
	30 x 40	2.70						
	35 x 30	2.55						
2700	30 x 45	2.90						
	35 x 35	2.85						
3300	30 x 50	3.25						
	35 x 40	3.25						
3900	35 x 45	3.70						
4700	30 x 50	3.80						
	35 x 50	3.80						

Note: I. Ripple Current: (A/rms) 105°C, 120Hz



## CASE SIZE & PERMISSIBLE RIPPLE CURRENT OF STANDARD PRODUCTS

D × L: mm

CAP. (μF)	RATED VOLTAGE WV (SURGE VOLTAGE WV)												
	250 (300) SIZE		350 (400) SIZE		400 (450) SIZE		420 (470) SIZE		450 (500) SIZE				
		RIPPLE		RIPPLE		RIPPLE		RIPPLE		RIPPLE			
47					22 × 20	0.35			22 × 25	0.38			
56			22 × 20	0.40	22 × 20	0.40			22 × 25	0.40			
68			22 × 25	0.45	22 × 25	0.50			22 × 30	0.50			
					25 × 20	0.50			25 × 25	0.50			
82			22 × 25	0.55	22 × 25	0.52			22 × 30	0.52			
					25 × 20	0.50	22 × 30	0.60		22 × 35	0.55		
					25 × 25	0.65			25 × 30	0.55			
									30 × 25	0.55			
100	22 × 25	0.56	22 × 30	0.70	22 × 30	0.60			22 × 30	0.55			
							25 × 25	0.65			22 × 40	0.65	
							25 × 25	0.65			25 × 30	0.60	
							25 × 30	0.65			30 × 25	0.65	
120	22 × 20	0.60	22 × 35	0.75	22 × 35	0.70			22 × 35	0.60			
							25 × 30	0.70			22 × 45	0.70	
					30 × 25	0.75			30 × 25	0.75		25 × 35	0.70
											30 × 30	0.70	
											35 × 25	0.70	
150	22 × 25	0.65	22 × 40	0.80	22 × 35	0.72	22 × 35	0.58	22 × 40	0.68			
							22 × 40	0.80	22 × 40	0.65	22 × 50	0.80	
					30 × 25	0.85	25 × 30	0.85	25 × 30	0.70	25 × 40	0.80	
							25 × 35	0.85			30 × 30	0.75	
							30 × 30	0.85			35 × 25	0.75	
				35 × 25	0.80								
180	22 × 25	0.80	22 × 45	0.90	22 × 40	0.81	22 × 40	0.68	22 × 45	0.75			
							22 × 50	0.95	25 × 35	0.68	25 × 45	0.85	
	25 × 20	0.75	25 × 35	0.90	25 × 40	0.95			30 × 35	0.85			
							30 × 30	0.90	30 × 30	0.90	35 × 30	0.85	
220	22 × 30	0.95	22 × 50	1.05	25 × 45	1.05	25 × 40	0.85	22 × 50	0.85			
	25 × 25	0.95	25 × 40	1.05	30 × 30	1.05	25 × 45	0.95	25 × 50	1.00			
							30 × 30	1.00	30 × 40	0.95	30 × 40	1.00	
							35 × 25	1.05	35 × 30	1.10	35 × 30	1.00	

Note: I. Ripple Current: (A/rms) 105°C, 120Hz



## CASE SIZE & PERMISSIBLE RIPPLE CURRENT OF STANDARD PRODUCTS

D x L: mm

CAP. (μF)	RATED VOLTAGE WV (SURGE VOLTAGE WV)									
	250 (300) SIZE		350 (400) SIZE		400 (450) SIZE		420 (470) SIZE		450 (500) SIZE	
		RIPPLE		RIPPLE		RIPPLE		RIPPLE		RIPPLE
270	22 x 35	1.15	25 x 45	1.20	22 x 45	1.10	25 x 45	1.05	25 x 50	1.05
	25 x 30	1.15	30 x 35	1.20	25 x 50	1.20	30 x 40	1.05	30 x 45	1.15
	30 x 25	1.15	35 x 30	1.20	30 x 40	1.20	35 x 30	1.05	35 x 35	1.15
					35 x 35	1.20				
330	22 x 40	1.25	30 x 40	1.35	25 x 50	1.25	25 x 50	1.15	30 x 45	1.25
	25 x 30	1.20	30 x 45	1.35	30 x 45	1.40	30 x 40	1.15	30 x 50	1.40
	30 x 25	1.25	35 x 35	1.35	35 x 35	1.35	35 x 35	1.15	35 x 40	1.40
390	22 x 45	1.50	30 x 45	1.50	30 x 45	1.42	30 x 45	1.25	30 x 50	1.40
	25 x 35	1.50	35 x 35	1.50	30 x 50	1.55			35 x 45	1.55
	30 x 30	1.50			35 x 40	1.55				
470	22 x 50	1.55	35 x 40	1.70	30 x 45	1.45	30 x 50	1.40	35 x 40	1.47
	25 x 40	1.55			30 x 50	1.75	35 x 40	1.35	35 x 45	1.68
	30 x 30	1.55			35 x 40	1.65			35 x 50	1.70
	35 x 25	1.55			35 x 45	1.75				
					35 x 50	1.75				
560	25 x 45	1.80	35 x 45	1.90	30 x 60	1.90	35 x 45	1.65	35 x 50	1.80
	30 x 35	1.80			35 x 45	1.80			35 x 60	2.10
	35 x 30	1.80			35 x 50	1.90				
680	25 x 50	1.95	35 x 50	2.10	35 x 50	2.10				
	30 x 40	2.00			35 x 60	2.15				
	35 x 35	2.00								
820	30 x 45	2.15								
	35 x 35	2.10								
1000	30 x 45	2.10								
	35 x 40	2.30								
1500	35 x 50	3.63								

Note: I. Ripple Current: (A/rms) 105°C, 120Hz

# Large Can Aluminum Electrolytic Capacitors

# LV [ For Long Life ]

For Printed Circuit Board High-Performance Aluminum Electrolytic Power Supply Input and Output Filter Capacitors



## DESCRIPTION

Features : 105°C 3000 hours, Longer life than LG, Snap-in terminal, High ripple current.

Recommended Applications : Smoothing circuit, TV/ Monitor, Adapter, SMPS.

### MULTIPLIER FOR RIPPLE CURRENT

Frequency Coefficient

<b>FREQUENCY (Hz)</b>	50	60	120	400
<b>COEFFICIENT</b>	0.8	0.85	1.0	1.14
<b>FREQUENCY (Hz)</b>	1K	2.4K	5K	10K
<b>COEFFICIENT</b>	1.23	1.3	1.36	1.4

## ELECTRICAL CHARACTERISTICS

Operating Temperature Range	-40 to +105°C	-25 to +105°C																								
Rated Voltage Range	10 to 100VDC	160 to 450VDC																								
Rated Capacitance Range	560 ~ 68000µF	270 ~ 2200µF																								
Capacitance Tolerance	±20% at 120Hz, 20°C																									
Leakage Current	$I \leq 0.02CV$ or 3mA whichever is smaller (After Rated Voltage Applied for 5 Minutes) $I$ = Leakage Current (µA), $C$ = Nominal Capacitance (µF), $V$ = Rated Voltage (V)																									
Dissipation Factor (tanδ) (20°C, 120Hz)	<table border="1"> <tr> <td>Rate Voltage (V)</td> <td>10</td> <td>16</td> <td>25</td> <td>35</td> <td>50</td> <td>63</td> <td>80</td> <td>100</td> <td>160</td> <td>180~400</td> <td>450</td> </tr> <tr> <td>D.F (%)</td> <td>55</td> <td>55</td> <td>45</td> <td>40</td> <td>35</td> <td>30</td> <td>25</td> <td>25</td> <td>15</td> <td>15</td> <td>25</td> </tr> </table> Dissipation Factor (tan δ) shall not exceed the values showed as above of standard rating		Rate Voltage (V)	10	16	25	35	50	63	80	100	160	180~400	450	D.F (%)	55	55	45	40	35	30	25	25	15	15	25
Rate Voltage (V)	10	16	25	35	50	63	80	100	160	180~400	450															
D.F (%)	55	55	45	40	35	30	25	25	15	15	25															
Endurance	After the rated voltage has been applied at 105°C for 3000 hours, the capacitors shall meet the following requirements. (a) Capacitance Change : Within ±20% of the Initial Value (b) Dissipation Factor : Not Exceeding 200% of the Specified Value (c) Leakage current : Not Exceeding the Specified Value																									
Shelf Life	After having been placed at 105°C without voltage applied for 1000 hours, the capacitors shall meet the same requirements as Endurance.																									

## DIAGRAM OF DIMENSIONS

Unit: mm

Location of P.C.B. Holes

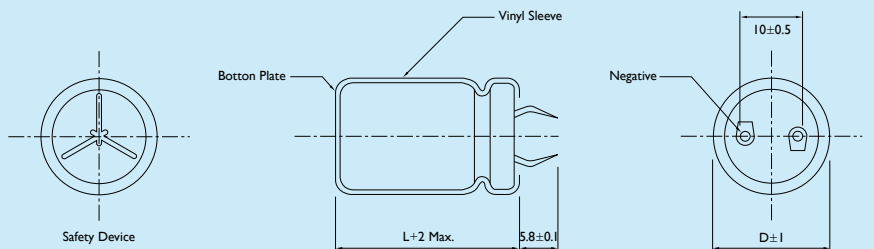
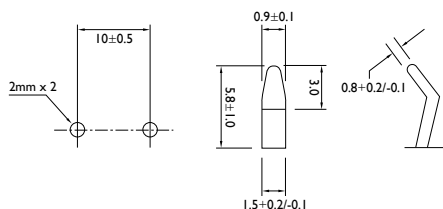

## CASE SIZE & PERMISSIBLE RIPPLE CURRENT OF STANDARD PRODUCTS

D x L: mm

CAP. (μF)	RATED VOLTAGE WV (SURGE VOLTAGE WV)											
	10 (13)		16 (20)		25 (32)		35 (44)		50 (63)		63 (79)	
	SIZE	RIPPLE	SIZE	RIPPLE	SIZE	RIPPLE	SIZE	RIPPLE	SIZE	RIPPLE	SIZE	RIPPLE
1200											22 x 25	1.25
1500									22 x 25	1.25	22 x 30	1.45
											25 x 25	1.45
1800									22 x 30	1.45	22 x 35	1.60
											25 x 30	1.60
2200									22 x 30	1.60	22 x 40	1.89
									25 x 25	1.60	25 x 30	1.80
											30 x 25	1.85
2700							22 x 25	1.45	22 x 35	1.80	22 x 45	2.06
									25 x 30	1.80	25 x 35	2.00
											30 x 30	2.08
3300							22 x 30	1.60	22 x 40	2.05	25 x 40	2.32
									25 x 30	1.95	30 x 30	2.30
									30 x 25	2.01	35 x 25	2.35
3900					22 x 25	1.50	22 x 30	1.80	22 x 45	2.27	25 x 45	2.55
									25 x 35	2.20	30 x 35	2.55
									30 x 30	2.29	35 x 30	2.63
4700					22 x 30	1.80	22 x 35	2.23	22 x 50	2.50	25 x 50	2.83
							25 x 25	2.10	25 x 40	2.42	30 x 40	2.86
									30 x 30	2.40	35 x 30	2.80
									35 x 25	2.45		
5600					22 x 30	1.95	22 x 40	2.41	25 x 45	2.70	30 x 45	3.18
					25 x 25	1.95	25 x 30	2.30	30 x 35	2.70	35 x 35	3.15
							30 x 25	2.37	35 x 30	2.78		
6800			22 x 25	1.80	22 x 35	2.20	22 x 45	2.68	30 x 40	3.06	30 x 50	3.50
					25 x 30	2.20	25 x 35	2.60	35 x 30	3.00	35 x 40	3.50
							30 x 30	2.70				
8200			22 x 30	2.05	22 x 40	2.47	22 x 50	3.02	30 x 45	3.38	35 x 45	3.90
			25 x 25	2.05	25 x 35	2.50	25 x 40	2.93	35 x 35	3.35		
					30 x 25	2.45	30 x 30	2.90				
							35 x 25	2.96				

Note: I. Ripple Current: (A/rms) 105°C, 120Hz



## CASE SIZE & PERMISSIBLE RIPPLE CURRENT OF STANDARD PRODUCTS

D × L: mm

CAP. (μF)	RATED VOLTAGE WV (SURGE VOLTAGE WV)											
	10 (13) SIZE		16 (20) SIZE		25 (32) SIZE		35 (44) SIZE		50 (63) SIZE		63 (79) SIZE	
		RIPPLE		RIPPLE		RIPPLE		RIPPLE		RIPPLE		RIPPLE
10000	22 × 25	1.80	22 × 35	2.45	22 × 45	2.75	25 × 45	3.20	30 × 50	3.50		
			25 × 30	2.45	25 × 40	2.80	30 × 35	3.20	35 × 40	3.70		
					30 × 30	2.75	35 × 30	3.30				
12000	22 × 30	2.05	22 × 40	2.73	22 × 50	3.13	25 × 50	3.64	35 × 50	4.20		
	25 × 25	2.05	25 × 30	2.60	25 × 45	3.22	30 × 40	3.67				
			30 × 25	2.68	30 × 35	3.19	35 × 30	3.60				
					35 × 25	3.10						
15000	22 × 35	2.45	22 × 45	2.99	25 × 50	3.43	30 × 45	4.04				
	25 × 30	2.45	25 × 35	2.90	30 × 40	3.47	35 × 35	4.00				
	30 × 25	2.55	30 × 30	3.02	35 × 30	3.40						
18000	22 × 40	2.94	22 × 50	3.43	30 × 45	3.94	35 × 40	4.60				
	25 × 30	2.80	25 × 40	3.33	35 × 35	3.90						
	30 × 30	3.11	30 × 30	3.30								
			35 × 25	3.37								
22000	22 × 45	3.24	25 × 45	3.70	30 × 50	4.30	35 × 50	5.10				
	25 × 35	3.15	30 × 35	3.70	35 × 40	4.30						
	30 × 30	3.28	35 × 30	3.81								
	35 × 25	3.37										
27000	25 × 40	3.50	30 × 40	4.15	35 × 45	4.85						
	30 × 35	3.67	35 × 35	4.27								
	35 × 30	3.78										
33000	25 × 45	4.00	30 × 50	4.65								
	30 × 40	4.20	35 × 40	4.65								
	35 × 30	4.08										
39000	25 × 50	4.45	35 × 45	5.25								
	30 × 45	4.67										
	35 × 35	4.63										
47000	35 × 40	4.90	35 × 50	5.80								
56000	35 × 45	5.50										
68000	35 × 50	6.05										

Note: I<sub>r</sub> Ripple Current: (A/rms) 105°C, 120Hz

## CASE SIZE & PERMISSIBLE RIPPLE CURRENT OF STANDARD PRODUCTS

D x L: mm

CAP. (μF)	RATED VOLTAGE WV (SURGE VOLTAGE WV)									
	80 (100) SIZE		100 (125) SIZE		160 (200) SIZE		180 (225) SIZE		200 (250) SIZE	
	SIZE	RIPPLE	SIZE	RIPPLE	SIZE	RIPPLE	SIZE	RIPPLE	SIZE	RIPPLE
220									22 x 25	0.85
270					22 x 25	0.85	22 x 25	0.85	22 x 30	1.00
330					22 x 30	1.00	22 x 30	1.10	22 x 30	1.15
									25 x 25	1.15
390					22 x 30	1.15	22 x 35	1.32	22 x 35	1.30
					25 x 25	1.15	25 x 25	1.25	25 x 30	1.30
470					22 x 35	1.30	22 x 40	1.47	22 x 40	1.52
					25 x 30	1.30	25 x 30	1.40	25 x 35	1.54
									30 x 25	1.49
560			22 x 25	1.20	22 x 40	1.57	22 x 45	1.70	22 x 45	1.70
					25 x 30	1.50	25 x 35	1.63	25 x 35	1.65
					30 x 25	1.54	30 x 25	1.60	30 x 30	1.72
680			22 x 30	1.35	22 x 45	1.75	22 x 50	1.87	25 x 45	1.97
					25 x 35	1.70	25 x 40	1.82	30 x 35	1.97
					30 x 30	1.77	30 x 30	1.80	35 x 30	2.02
							35 x 25	1.84		
820	22 x 25	1.20	22 x 30	1.50	22 x 50	2.03	25 x 45	2.05	25 x 45	2.20
			25 x 25	1.50	25 x 40	1.97	30 x 35	2.05	30 x 35	2.10
					30 x 30	1.95	35 x 30	2.11	35 x 30	2.16
					35 x 25	1.99				
1000	22 x 30	1.35	22 x 35	1.70	25 x 45	2.15	25 x 50	2.27	30 x 45	2.32
			25 x 30	1.70	30 x 35	2.15	30 x 40	2.29	35 x 35	2.30
					35 x 30	2.21	35 x 30	2.25		
1200	22 x 35	1.59	22 x 40	1.97	30 x 40	2.45	30 x 45	2.57	30 x 50	2.75
	25 x 25	1.50	25 x 35	1.99	35 x 35	2.52	35 x 35	2.55	35 x 40	2.75
			30 x 25	1.95						
1500	22 x 40	1.78	22 x 45	2.15	30 x 50	2.75	35 x 40	2.85	35 x 45	2.90
	25 x 30	1.70	25 x 40	2.19	35 x 40	2.75				
	30 x 25	1.75	30 x 30	2.15						
			35 x 25	2.21						

Note: I. Ripple Current: (A/rms) 105°C, 120Hz



## CASE SIZE & PERMISSIBLE RIPPLE CURRENT OF STANDARD PRODUCTS

D × L: mm

CAP. (μF)	RATED VOLTAGE WV (SURGE VOLTAGE WV)									
	80 (100) SIZE		100 (125) SIZE		160 (200) SIZE		180 (225) SIZE		200 (250) SIZE	
		RIPPLE		RIPPLE		RIPPLE		RIPPLE		RIPPLE
1800	22 × 45	2.01	25 × 45	2.45	35 × 45	3.00	35 × 50	3.10		
	25 × 35	1.95	30 × 35	2.45						
	30 × 30	2.03	35 × 30	2.52						
2200	25 × 40	2.17	25 × 50	2.75	35 × 50	3.50				
	30 × 30	2.15	30 × 40	2.75						
	35 × 25	2.19	35 × 35	2.86						
2700	25 × 45	2.45	30 × 45	3.08						
	30 × 35	2.45	35 × 35	3.05						
	35 × 30	2.52								
3300	30 × 40	2.75	30 × 50	3.45						
	35 × 35	2.83	35 × 40	3.45						
3900	30 × 45	3.13	35 × 45	3.90						
	35 × 35	3.10								
4700	35 × 40	3.40	35 × 45	3.90						
			35 × 50	4.30						
5600	35 × 50	3.80								

Note: I<sub>r</sub> Ripple Current: (A/rms) 105°C, 120Hz

## CASE SIZE & PERMISSIBLE RIPPLE CURRENT OF STANDARD PRODUCTS

D x L: mm

CAP. (μF)	RATED VOLTAGE WV (SURGE VOLTAGE WV)									
	250 (300) SIZE		315 (365) SIZE		350 (400) SIZE		400 (450) SIZE		450 (500) SIZE	
		RIPPLE		RIPPLE		RIPPLE		RIPPLE		RIPPLE
56									22 x 25	0.55
68							22 x 25	0.55	22 x 30	0.65
82			22 x 25	0.55	22 x 25	0.60	22 x 30	0.65	22 x 35	0.80
							25 x 25	0.65	25 x 25	0.75
100			22 x 30	0.65	22 x 30	0.70	22 x 35	0.79	22 x 40	0.89
					25 x 25	0.70	25 x 25	0.75	25 x 30	0.85
									30 x 25	0.85
120			22 x 30	0.75	22 x 35	0.80	22 x 40	0.89	22 x 45	0.95
			25 x 25	0.75	25 x 30	0.80	25 x 30	0.85	25 x 35	0.92
							30 x 25	0.87	30 x 25	0.90
150	22 x 25	0.75	22 x 35	0.80	22 x 40	0.86	22 x 40	0.85	22 x 50	1.14
			25 x 30	0.80	25 x 35	0.87	22 x 45	0.93	25 x 40	1.11
					30 x 25	0.85	25 x 35	0.90	30 x 30	1.10
							30 x 30	0.94		
							35 x 25	0.96		
180	22 x 30	0.85	22 x 40	1.01	22 x 45	1.05	22 x 50	1.14	25 x 45	1.25
			25 x 35	1.02	25 x 40	1.07	25 x 40	1.11	30 x 35	1.24
			30 x 25	1.00	30 x 30	1.05	30 x 30	1.10	35 x 25	1.20
							35 x 25	1.12		
220	22 x 30	1.00	22 x 45	1.10	22 x 50	1.16	25 x 45	1.20	25 x 50	1.36
	25 x 25	1.00	25 x 40	1.12	25 x 45	1.20	30 x 35	1.20	30 x 40	1.38
			30 x 30	1.10	30 x 35	1.18	35 x 30	1.24	35 x 30	1.35
					35 x 25	1.15				
270	22 x 35	1.22	25 x 45	1.25	25 x 50	1.31	25 x 50	1.36	30 x 45	1.51
	25 x 25	1.15	30 x 35	1.25	30 x 40	1.33	30 x 40	1.38	35 x 35	1.50
					35 x 30	1.30	35 x 30	1.35		
330	22 x 40	1.36	25 x 50	1.53	30 x 45	1.46	30 x 45	1.51	30 x 45	1.50
	25 x 30	1.30	30 x 40	1.53	35 x 35	1.45	35 x 35	1.50	30 x 50	1.70
			35 x 30	1.50					35 x 40	1.70

Note: I. Ripple Current: (A/rms) 105°C, 120Hz



## CASE SIZE & PERMISSIBLE RIPPLE CURRENT OF STANDARD PRODUCTS

D x L: mm

CAP. (μF)	RATED VOLTAGE WV (SURGE VOLTAGE WV)									
	250 (300) SIZE		315 (365) SIZE		350 (400) SIZE		400 (450) SIZE		450 (500) SIZE	
	SIZE	RIPPLE	SIZE	RIPPLE	SIZE	RIPPLE	SIZE	RIPPLE	SIZE	RIPPLE
390	22 x 45	1.54	30 x 45	1.71	30 x 50	1.65	30 x 50	1.70	35 x 45	1.90
	25 x 35	1.48	35 x 30	1.60	35 x 40	1.65	35 x 40	1.70		
	30 x 25	1.45								
	35 x 25	1.59								
470	22 x 50	1.78	30 x 50	1.85	35 x 45	1.85	35 x 40	1.70	35 x 50	2.10
	25 x 40	1.75	35 x 35	1.75			35 x 45	1.90		
	30 x 30	1.72								
	35 x 30	1.88								
560	25 x 40	1.80	35 x 40	2.00	35 x 50	2.10	35 x 50	1.90		
	30 x 35	1.89								
	35 x 30	1.94								
680	25 x 50	2.10	35 x 45	2.20	35 x 50	2.30	35 x 50	2.10		
	30 x 40	2.10								
	35 x 35	2.18								
820	30 x 45	2.30								
	35 x 40	2.39								
1000	30 x 50	2.55								
	35 x 40	2.40								
	35 x 45	2.65								
1200	35 x 50	2.90								

Note: I. Ripple Current: (A/rms) 105°C, 120Hz



# LC [ High Temperature and Long Life ]

105°C 5000 Hours, Wide Temperature Range and Long Life

## Large Can Aluminum Electrolytic Capacitors

### ELECTRICAL CHARACTERISTICS

Operating Temperature Range	-25 ~ +105°C		
Rated Voltage Range	160 ~ 450VDC		
Rated Capacitance Range	270 ~ 2200μF		
Capacitance Tolerance	±20% at 120Hz, 20°C		
Leakage Current	Leakage Current (Max.) (20°C) : I = 0.02CV or 3μA whichever is greater. (After Rated Voltage Applied for 5 Minutes)		
Dissipation Factor (Max. tanδ) (20°C, 120Hz)	Rated Voltage (V)	160~400	450
	D.F (%)	15	25
Endurance	After the rated voltage has been applied at 105°C for 5000 hours, the capacitors shall meet the following requirements. (a) Capacitance Change : Within ±20% of Initial Value (b) Dissipation Factor: Not Exceeding 200% of the Specified Value (c) Leakage Current: Not Exceeding the Specified Value		
Shelf Life	After having been placed at 105°C without voltage applied for 1000 hours, the capacitors shall meet the same requirements as Endurance.		

### DIAGRAM OF DIMENSIONS

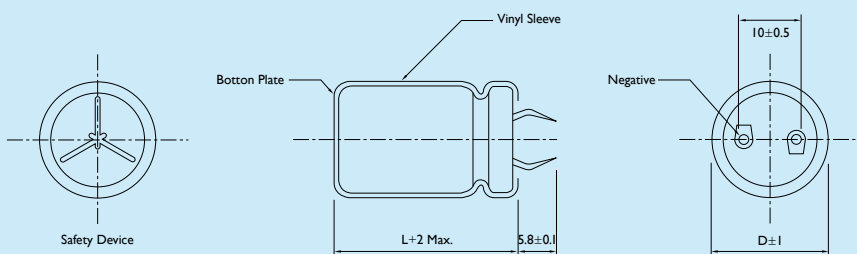

### DESCRIPTION

Longer life than HW, Snap-in terminal, High ripple current.  
Applications: Smoothing circuit, TV/Monitor, Adapter, SMPS

### MULTIPLIER FOR RIPPLE CURRENT

Frequency Coefficient				
<b>FREQUENCY (Hz)</b>	50	60	120	400
<b>COEFFICIENT</b>	0.80	0.85	1.00	1.14
<b>FREQUENCY (Hz)</b>	1K	2.4K	5K	10K
<b>COEFFICIENT</b>	1.23	1.30	1.36	1.40

Unit: mm

### Location of P.C.B. Holes

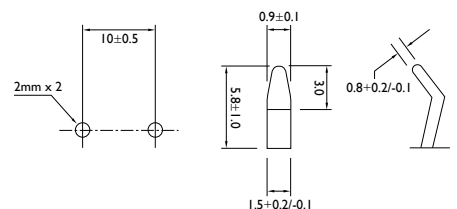



## CASE SIZE & PERMISSIBLE RIPPLE CURRENT OF STANDARD PRODUCTS

D × L: mm

CAP. (μF)	RATED VOLTAGE WV (SURGE VOLTAGE WV)							
	160 (200) SIZE		180 (225) SIZE		200 (250) SIZE		250 (300) SIZE	
		RIPPLE		RIPPLE		RIPPLE		RIPPLE
150							22 × 25	0.75
180							22 × 30	0.85
220					22 × 25	0.85	22 × 30	1.00
							25 × 25	1.00
270	22 × 25	0.85	22 × 25	0.85	22 × 30	1.00	22 × 35	1.22
							25 × 25	1.15
330	22 × 30	1.00	22 × 30	1.10	22 × 30	1.15	22 × 40	1.36
					25 × 25	1.15	25 × 30	1.30
390	22 × 30	1.15	22 × 35	1.32	22 × 35	1.30	22 × 45	1.54
	25 × 25	1.15	25 × 25	1.25	25 × 30	1.30	25 × 35	1.48
							30 × 25	1.45
							35 × 25	1.59
470	22 × 35	1.30	22 × 40	1.47	22 × 40	1.52	22 × 50	1.78
	25 × 30	1.30	25 × 30	1.40	25 × 35	1.54	25 × 40	1.75
					30 × 25	1.49	30 × 30	1.72
							35 × 30	1.88
560	22 × 40	1.57	22 × 45	1.70	22 × 45	1.70	25 × 40	1.80
	25 × 30	1.50	25 × 35	1.63	25 × 35	1.65	30 × 35	1.89
	30 × 25	1.54	30 × 25	1.60	30 × 30	1.72	35 × 30	1.94
680	22 × 45	1.75	22 × 50	1.87	25 × 45	1.97	25 × 50	2.10
	25 × 35	1.70	25 × 40	1.82	30 × 35	1.97	30 × 40	2.10
	30 × 30	1.77	30 × 30	1.80	35 × 30	2.02	35 × 35	2.18
			35 × 25	1.84				
820	22 × 50	2.03	25 × 45	2.05	25 × 45	2.20	30 × 45	2.30
	25 × 40	1.97	30 × 35	2.05	30 × 35	2.10	35 × 40	2.39
	30 × 30	1.95	35 × 30	2.11	35 × 30	2.16		
	35 × 25	1.99						
1000	25 × 45	2.15	25 × 50	2.27	30 × 45	2.32	30 × 50	2.55
	30 × 35	2.15	30 × 40	2.29	35 × 35	2.30	35 × 45	2.65
	35 × 30	2.21	35 × 30	2.25				
1200	30 × 40	2.45	30 × 45	2.57	30 × 50	2.75	35 × 50	2.90
	35 × 35	2.52	35 × 35	2.55	35 × 40	2.75		
1500	30 × 50	2.75	35 × 40	2.85	35 × 45	2.90		
	35 × 40	2.75						
1800	35 × 45	3.00	35 × 50	3.10				
2200	35 × 50	3.50						

Note: 1. Ripple Current: (A/rms) 105°C, 120Hz

2. Dissipation Factor: 20°C, 120Hz

3. ESR: 120Hz / 20°C (Ω Max.)

## CASE SIZE & PERMISSIBLE RIPPLE CURRENT OF STANDARD PRODUCTS

D x L: mm

CAP. (μF)	RATED VOLTAGE WV (SURGE VOLTAGE WV)							
	315 (365) SIZE		350 (400) SIZE		400 (450) SIZE		450 (500) SIZE	
	SIZE	RIPPLE	SIZE	RIPPLE	SIZE	RIPPLE	SIZE	RIPPLE
56							22 x 25	0.55
68					22 x 25	0.55	22 x 30	0.65
82	22 x 25	0.55	22 x 25	0.60	22 x 30	0.65	22 x 35	0.80
					25 x 25	0.65	25 x 25	0.75
100	22 x 30	0.65	22 x 30	0.70	22 x 35	0.79	22 x 40	0.89
			25 x 25	0.70	25 x 25	0.75	25 x 30	0.85
120	22 x 30	0.75	22 x 35	0.80	22 x 40	0.89	22 x 45	0.95
	25 x 25	0.75	25 x 30	0.80	25 x 30	0.85	25 x 35	0.92
					30 x 25	0.87	30 x 25	0.90
150	22 x 35	0.80	22 x 40	0.86	22 x 45	0.93	22 x 50	1.14
	25 x 30	0.80	25 x 35	0.87	25 x 35	0.90	25 x 40	1.11
			30 x 25	0.85	30 x 30	0.94	30 x 30	1.10
					35 x 25	0.96		
180	22 x 40	1.01	22 x 45	1.05	22 x 50	1.14	25 x 45	1.25
	25 x 35	1.02	25 x 40	1.07	25 x 40	1.11	30 x 35	1.24
	30 x 25	1.00	30 x 30	1.05	30 x 30	1.10	35 x 25	1.20
					35 x 25	1.12		
220	22 x 45	1.10	22 x 50	1.16	25 x 45	1.20	25 x 50	1.36
	25 x 40	1.12	25 x 45	1.20	30 x 35	1.20	30 x 40	1.38
	30 x 30	1.10	30 x 35	1.18	35 x 30	1.24	35 x 30	1.35
			35 x 25	1.15				
270	25 x 45	1.25	25 x 50	1.31	25 x 50	1.36	30 x 45	1.51
	30 x 35	1.25	30 x 40	1.33	30 x 40	1.38	35 x 35	1.50
			35 x 30	1.30	35 x 30	1.35		
330	25 x 50	1.53	30 x 45	1.46	30 x 45	1.51	30 x 50	1.70
	30 x 40	1.53	35 x 35	1.45	35 x 35	1.50	35 x 40	1.70
	35 x 30	1.50						
390	30 x 45	1.71	30 x 50	1.65	30 x 50	1.70	35 x 45	1.90
	35 x 30	1.60	35 x 40	1.65	35 x 40	1.70		
470	30 x 50	1.85	35 x 45	1.85	35 x 45	1.90	35 x 50	2.10
	35 x 35	1.75						
560	35 x 40	2.00	35 x 50	2.10				
680	35 x 45	2.20						

Note: 1. Ripple Current: (A/rms) 105°C, 120Hz

2. Dissipation Factor: 20°C, 120Hz

3. ESR: 120Hz / 20°C (Ω Max.)

# Surface Mount Aluminum Electrolytic

# CA [ For General ]



## FEATURE

For General Purpose Series with 85°C 2000 Hours  
 Suitable for AV (TV, Video, Audio) Monitor / Computer,  
 Home appliance, OA / HA / Communication

## MARKING

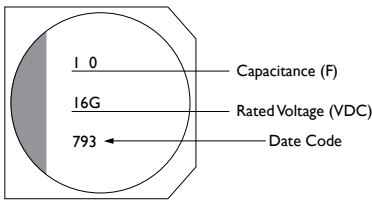

## ELECTRICAL CHARACTERISTICS

Operation Temperature Range	-40 to +85°C									
Rated Voltage Range	4 to 100VDC									
Rated Capacitance Range	0.1 ~ 1000μF									
Capacitance Tolerance	±20% at 120Hz, 20°C									
Leakage Current (Max. 20°C)	I ≤ 0.01CV (μA) or 3μA whichever is greater: (After 2 Minutes Application of DC Rated Voltage at 20°C) I = Leakage Current (μA), C = Rated Capacitance (μF), V = Rated Voltage (V)									
Low Temperature Stability	Impedance Ratio at 120Hz (Max.)									
	WV (V)	4	6.3	10	16	25	35	50	63	100
	Z (-25°C)	7	4	3	2	2	2	2	2	3
	Z (-40°C)	15	8	6	4	4	3	3	3	2
Endurance	After the rated voltage has been applied at 85°C for 2000 hours, the capacitors shall meet the following requirements. (a) Capacitance Change: Within ±20% of the Initial Value (b) Dissipation Factor: Not Exceeding 200% of Specified Value (c) Leakage Current: Not Exceeding the Specified Value									
Shelf Life	After having been placed at 85°C without voltage applied for 1000 hours, the capacitors shall meet the same requirements as Endurance.									

## DIMENSIONS

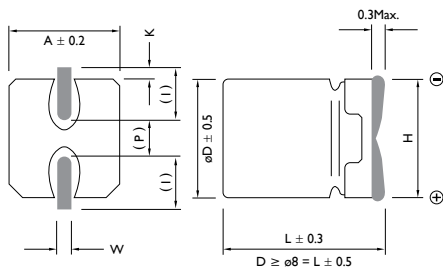

( ) Reference Size

Unit: mm

SIZE CODE	Dø	L	A	H	I	W	P	K
B	4.0	5.4	4.3	5.5 Max.	1.8	0.65 ± 0.1	1.0±0.2	0.35 <sup>+ 0.15</sup> <sub>- 0.20</sub>
C	5.0	5.4	5.3	6.5 Max.	2.2	0.65 ± 0.1	1.5±0.2	0.35 <sup>+ 0.15</sup> <sub>- 0.20</sub>
D	6.3	5.4	6.6	7.8 Max.	2.6	0.65 ± 0.1	1.8±0.2	0.35 <sup>+ 0.15</sup> <sub>- 0.20</sub>
E	8.0	6.5	8.3	9.5 Max.	3.4	0.65 ± 0.1	2.2±0.2	0.35 <sup>+ 0.15</sup> <sub>- 0.20</sub>
F	8.0	10.5	8.3	10.0 Max.	3.4	0.90 ± 0.2	3.1±0.2	0.70 ± 0.20
G	10.0	10.5	10.3	12.0 Max.	3.5	0.90 ± 0.2	4.6±0.2	0.70 ± 0.20
H	6.3	7.7	6.6	7.8 Max.	2.6	0.65 ± 0.1	1.8±0.2	0.35 <sup>+ 0.15</sup> <sub>- 0.20</sub>

## CASE SIZE & PERMISSIBLE RIPPLE CURRENT OF STANDARD PRODUCTS

D x L: mm

### CAP. RATED VOLTAGE WV (SURGE VOLTAGE WV)

(μF)	4 (5)			6.3 (8)			10 (13)			16 (20)		
	SIZE	RIPPLE CURRENT	DISSIPATION FACTOR	SIZE	RIPPLE CURRENT	DISSIPATION FACTOR	SIZE	RIPPLE CURRENT	DISSIPATION FACTOR	SIZE	RIPPLE CURRENT	DISSIPATION FACTOR
4.7										4 x 5.4	20	0.16
10							4 x 5.4	14	0.30	4 x 5.4	28	0.16
22	4 x 5.4	19	0.35	4 x 5.4	20	0.26	4 x 5.4	28	0.30	4 x 5.4	27	0.26
										5 x 5.4	39	0.16
33	4 x 5.4	26	0.35	5 x 5.4	22	0.26	4 x 5.4	29	0.30	5 x 5.4	45	0.26
							5 x 5.4	43	0.20	6.3 x 5.4	66	0.16
47	4 x 5.4	34	0.35	4 x 5.4	38	0.26	5 x 5.4	43	0.30	6.3 x 5.4	70	0.16
				5 x 5.4	46	0.26	6.3 x 5.4	46	0.30	6.3 x 7.7	75	0.18
100	5 x 5.4	61	0.35	6.3 x 5.4	71	0.26	5 x 5.4	60	0.30	6.3 x 5.4	70	0.20
							6.3 x 5.4	70	0.26	6.3 x 7.7	85	0.20
										8 x 6.5	86	0.20
220	6.3 x 5.4	82	0.35	6.3 x 5.4	190	0.26	6.3 x 7.7	105	0.26	6.3 x 7.7	105	0.20
				6.3 x 7.7	235	0.35	8 x 6.5	250	0.26	8 x 10.5	280	0.20
				8 x 6.5	250	0.35						
330				6.3 x 7.7	280	0.35	8 x 10.5	330	0.26	8 x 10.5	316	0.20
				8 x 6.5	300	0.35				10 x 10.5	380	0.20
				8 x 10.5	340	0.35						
470				8 x 10.5	380	0.35	8 x 10.5	330	0.26	8 x 10.5	350	0.20
							10 x 10.5	400	0.26	10 x 10.5	420	0.20
1000				8 x 10.5	580	0.35	10 x 10.5	580	0.26			
				10 x 10.5	700	0.35						
1500				10 x 10.5	1000	0.35						

Note: 1. Ripple Current: (mA/rms) 85°C, 120Hz

2. Dissipation Factor: 20°C, 120Hz



## CASE SIZE & PERMISSIBLE RIPPLE CURRENT OF STANDARD PRODUCTS

D × L: mm

CAP. (μF)	RATED VOLTAGE WV (SURGE VOLTAGE WV)								
	25 (32)			35 (44)			50 (63)		
	SIZE	RIPPLE CURRENT	DISSIPATION FACTOR	SIZE	RIPPLE CURRENT	DISSIPATION FACTOR	SIZE	RIPPLE CURRENT	DISSIPATION FACTOR
0.10							4 × 5.4	1	0.12
0.22							4 × 5.4	2	0.12
0.33							4 × 5.4	3	0.12
0.47							4 × 5.4	5	0.12
1.0							4 × 5.4	10	0.12
2.2				4 × 5.4	8	0.12	4 × 5.4	16	0.12
3.3				4 × 5.4	10	0.12	4 × 5.4	16	0.12
4.7	4 × 5.4	22	0.14	4 × 5.4	22	0.12	5 × 5.4	23	0.12
10	4 × 5.4	24	0.20	4 × 5.4	24	0.16	5 × 5.4	28	0.12
	5 × 5.4	28	0.14	5 × 5.4	30	0.12	6.3 × 5.4	35	0.12
22	5 × 5.4	45	0.14	5 × 5.4	49	0.23	6.3 × 5.4	70	0.12
	6.3 × 5.4	55	0.14	6.3 × 5.4	60	0.12	6.3 × 7.7	90	0.12
							8 × 6.5	110	0.12
33	5 × 5.4	53	0.14	6.3 × 5.4	100	0.14	6.3 × 7.7	90	0.12
	6.3 × 5.4	65	0.14	8 × 6.5	130	0.14	8 × 10.5	120	0.12
47	6.3 × 5.4	70	0.20	6.3 × 7.7	150	0.14	6.3 × 7.7	63	0.12
	8 × 6.5	96	0.16	8 × 6.5	165	0.14	8 × 10.5	100	0.12
							10 × 10.5	130	0.12
100	6.3 × 7.7	115	0.16	6.3 × 7.7	140	0.14	8 × 10.5	160	0.12
	8 × 6.5	140	0.16	8 × 6.5	170	0.14	10 × 10.5	190	0.12
	8 × 10.5	180	0.16	10 × 10.5	210	0.14			
220	8 × 6.5	210	0.16	8 × 10.5	250	0.14	10 × 10.5	310	0.12
	8 × 10.5	260	0.16	10 × 10.5	310	0.14			
	10 × 10.5	310	0.16						
330	8 × 10.5	350	0.16	10 × 10.5	400	0.14			
	10 × 10.5	430	0.16						
470	10 × 10.5	480	0.16						

Note: 1. Ripple Current: (mA/rms) 85°C, 120Hz

2. Dissipation Factor: 20°C, 120Hz

**CASE SIZE & PERMISSIBLE RIPPLE CURRENT OF STANDARD PRODUCTS**

D x L: mm

CAP. (μF)	RATED VOLTAGE WV (SURGE VOLTAGE WV)					
	63 (79) SIZE			100 (125) SIZE		
		RIPPLE CURRENT	DISSIPATION FACTOR		RIPPLE CURRENT	DISSIPATION FACTOR
3.3				8 x 10.5	30	0.18
4.7	6.3 x 5.4	20	0.18	8 x 10.5	50	0.18
10	6.3 x 5.4	20	0.18	8 x 10.5	55	0.18
22	8 x 10.5	30	0.18	10 x 10.5	60	0.18
33	8 x 10.5	30	0.18	10 x 10.5	65	0.18
47	8 x 10.5	30	0.18			
100	10 x 10.5	60	0.18			

Note: 1. Ripple Current: (mA/rms) 85°C, 120Hz

2. Dissipation Factor: 20°C, 120Hz

# Surface Mount Aluminum Electrolytic

# CB [ For General ]



## FEATURE

For General Purposes Series with 105°C 1000 Hours  
 Suitable for AV (TV, Video, Audio) Monitor / Computer,  
 OA / HA / Communication

## MARKING

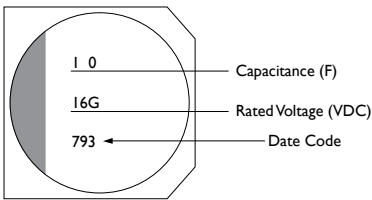

## DIMENSIONS

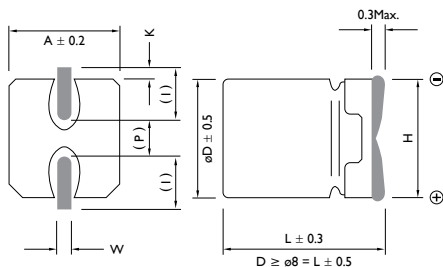

( ) Reference Size

## ELECTRICAL CHARACTERISTICS

Operation Temperature Range	-40 to +105°C									
Rated Voltage Range	4 to 100VDC									
Rated Capacitance Range	0.1 ~ 1000μF									
Capacitance Tolerance	±20% at 120Hz, 20°C									
Leakage Current (Max. 20°C)	I ≤ 0.01 CV (μA) or 3μA Whichever is greater. (After 2 Minutes Application of DC Rated Working Voltage at 20°C)									
Low Temperature Stability	Impedance Ratio at 120Hz									
	WV (V)	4	6.3	10	16	25	35	50	63	100
	Z (-25°C) / Z (+20°C)	7	4	3	2	2	2	2	2	2
	Z (-40°C) / Z (+20°C)	15	8	6	4	4	3	3	3	3
Endurance	After 1000 hours application of WV at 105°C, the capacitors shall meet following requirements. (a) Capacitance Change: Within ±20% of the Initial Value (b) Dissipation Factor: Not Exceeding 200% of Specified Value (c) Leakage Current: Not Exceeding the Specified Value									
Shelf Life	After having been placed at 105°C without voltage applied for 1000 hours, the capacitors shall meet the same requirements as Endurance.									

Unit: mm

SIZE CODE	Dø	L	A	H	I	W	P	K
B	4.0	5.4	4.3	5.5 Max.	1.8	0.65 ± 0.1	1.0 ± 0.2	0.35 <sup>+ 0.15</sup> <sub>- 0.20</sub>
C	5.0	5.4	5.3	6.5 Max.	2.2	0.65 ± 0.1	1.5 ± 0.2	0.35 <sup>+ 0.15</sup> <sub>- 0.20</sub>
D	6.3	5.4	6.6	7.8 Max.	2.6	0.65 ± 0.1	1.8 ± 0.2	0.35 <sup>+ 0.15</sup> <sub>- 0.20</sub>
E	8.0	6.5	8.3	9.5 Max.	3.4	0.65 ± 0.1	2.2 ± 0.2	0.35 <sup>+ 0.15</sup> <sub>- 0.20</sub>
F	8.0	10.5	8.3	10.0 Max.	3.4	0.90 ± 0.2	3.1 ± 0.2	0.70 ± 0.20
G	10.0	10.5	10.3	12.0 Max.	3.5	0.90 ± 0.2	4.6 ± 0.2	0.70 ± 0.20
H	6.3	7.7	6.6	7.8 Max.	2.6	0.65 ± 0.1	1.8 ± 0.2	0.35 <sup>+ 0.15</sup> <sub>- 0.20</sub>



**CASE SIZE & PERMISSIBLE RIPPLE CURRENT OF STANDARD PRODUCTS**

D x L: mm

**CAP. RATED VOLTAGE WV (SURGE VOLTAGE WV)**

(μF)	4 (5)			6.3 (8)			10 (13)			16 (20)		
	SIZE	RIPPLE CURRENT	DISSIPATION FACTOR	SIZE	RIPPLE CURRENT	DISSIPATION FACTOR	SIZE	RIPPLE CURRENT	DISSIPATION FACTOR	SIZE	RIPPLE CURRENT	DISSIPATION FACTOR
4.7										4 x 5.4	20	0.16
10							4 x 5.4	24	0.30	4 x 5.4	28	0.16
22	4 x 5.4	20	0.35	4 x 5.4	29	0.30	4 x 5.4	36	0.30	5 x 5.4	39	0.16
33	4 x 5.4	26	0.35	4 x 5.4	43	0.30	4 x 5.4	45	0.30	6.3 x 5.4	65	0.20
47	4 x 5.4	34	0.35	5 x 5.4	46	0.30	5 x 5.4	55	0.30	6.3 x 5.4	70	0.20
							6.3 x 5.4	70	0.30	6.3 x 7.7	125	0.20
100	5 x 5.4	61	0.35	5 x 5.4	58	0.35	8 x 6.5	110	0.30	6.3 x 5.4	100	0.20
				6.3 x 5.4	71	0.35			6.3 x 7.7	98	0.20	
								8 x 6.5	130	0.20		
220	6.3 x 5.4	82	0.35	6.3 x 5.4	95	0.35	6.3 x 7.7	115	0.30	6.3 x 7.7	100	0.20
				6.3 x 7.7	120	0.35	8 x 10.5	160	0.26	10 x 10.5	210	0.20
				8 x 6.5	130	0.35						
330				6.3 x 7.7	175	0.35	10 x 10.5	230	0.26	10 x 10.5	230	0.20
				8 x 10.5	230	0.35						
470				10 x 10.5	260	0.35	10 x 10.5	270	0.26	8 x 10.5	230	0.20
									10 x 10.5	275	0.20	
1000				10 x 10.5	380	0.35	10 x 10.5	390	0.26			

Note: 1. Ripple Current: (mA/rms) 105°C, 120Hz

2. Dissipation Factor: 20°C, 120Hz



## CASE SIZE & PERMISSIBLE RIPPLE CURRENT OF STANDARD PRODUCTS

D × L: mm

CAP. (μF)	RATED VOLTAGE WV (SURGE VOLTAGE WV)																	
	25 (32)			35 (44)			50 (63)											
	SIZE	RIPPLE CURRENT	DISSIPATION FACTOR	SIZE	RIPPLE CURRENT	DISSIPATION FACTOR	SIZE	RIPPLE CURRENT	DISSIPATION FACTOR									
0.10							4 × 5.4	1	0.12									
0.22							4 × 5.4	2	0.12									
0.33							4 × 5.4	3	0.12									
0.47							4 × 5.4	5	0.12									
1.0							4 × 5.4	10	0.12									
2.2				4 × 5.4	15	0.12	4 × 5.4	16	0.12									
3.3				4 × 5.4	18	0.12	4 × 5.4	16	0.12									
4.7	4 × 5.4	22	0.14	4 × 5.4	22	0.12	5 × 5.4	23	0.12									
10	4 × 5.4	23	0.14	5 × 5.4	30	0.12	6.3 × 5.4	35	0.12									
	5 × 5.4	28	0.14															
22	5 × 5.4	45	0.14	6.3 × 5.4	60	0.14	6.3 × 7.7	65	0.12									
	6.3 × 5.4	55	0.14							8 × 6.5	70	0.12						
33	6.3 × 5.4	65	0.16	8 × 6.5	84	0.14	6.3 × 7.7	70	0.12									
							8 × 10.5	91	0.12									
47	6.3 × 5.4	65	0.16	6.3 × 7.7	72	0.14	6.3 × 7.7	65	0.12									
										8 × 6.5	91	0.16	8 × 6.5	76	0.14	10 × 10.5	100	0.12
100	6.3 × 7.7	95	0.16	6.3 × 7.7	105	0.14	8 × 10.5	120	0.12									
	8 × 6.5	100	0.16	8 × 10.5	130	0.14	10 × 10.5	145	0.12									
	8 × 10.5	130	0.16	10 × 10.5	160	0.14												
220	8 × 10.5	220	0.16	10 × 10.5	240	0.14												
	10 × 10.5	273	0.16															
330																		
470	10 × 10.5	570	0.16															

Note: 1. Ripple Current: (mA/rms) 105°C, 120Hz

2. Dissipation Factor: 20°C, 120Hz

**CASE SIZE & PERMISSIBLE RIPPLE CURRENT OF STANDARD PRODUCTS**

D x L: mm

CAP. (μF)	RATED VOLTAGE WV (SURGE VOLTAGE WV)					
	63 (79) SIZE			100 (125) SIZE		
		RIPPLE CURRENT	DISSIPATION FACTOR		RIPPLE CURRENT	DISSIPATION FACTOR
3.3				8 x 10.5	30	0.18
4.7	6.3 x 5.4	20	0.18	8 x 10.5	50	0.18
10	6.3 x 5.4	20	0.18	8 x 10.5	55	0.18
22	8 x 10.5	30	0.18	10 x 10.5	60	0.18
33	8 x 10.5	30	0.18	10 x 10.5	65	0.18
47	8 x 10.5	30	0.18			
100	10 x 10.5	60	0.18			

Note: 1. Ripple Current: (mA/rms) 105°C, 120Hz

2. Dissipation Factor: 20°C, 120Hz

# Surface Mount Aluminum Electrolytic

# CE [ For Long Life ]



## FEATURE

For Long Life Series with 105°C 2000 Hours

Suitable for AV (TV, Video, Audio), Monitor / Computer, OA / HA / Communication

## MARKING

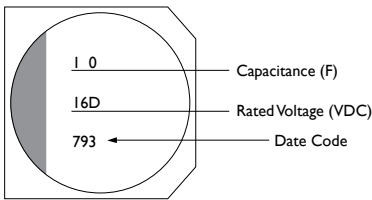

## ELECTRICAL CHARACTERISTICS

Operation Temperature Range	-40 to +105°C																											
Rated Voltage Range	6.3 to 100VDC																											
Rated Capacitance Range	0.1 ~ 1000μF																											
Capacitance Tolerance	±20% at 120Hz, 20°C																											
Leakage Current (Max. 20°C)	$I \leq 0.01CV$ (μA) or 3μA whichever is greater. (After Rated Voltage Applied for 2 Minutes) I = Leakage Current (μA), C = Rated Capacitance (μF), V = Rated Voltage (V)																											
Low Temperature Stability	Impedance Ratio at 120Hz <table border="1"> <tr> <td>WV (V)</td> <td>6.3</td> <td>10</td> <td>16</td> <td>25</td> <td>35</td> <td>50</td> <td>63</td> <td>100</td> </tr> <tr> <td>Z (-25°C) / Z (+20°C)</td> <td>4</td> <td>3</td> <td>2</td> <td>2</td> <td>2</td> <td>2</td> <td>2</td> <td>2</td> </tr> <tr> <td>Z (-40°C) / Z (+20°C)</td> <td>8</td> <td>6</td> <td>4</td> <td>4</td> <td>3</td> <td>3</td> <td>3</td> <td>3</td> </tr> </table>	WV (V)	6.3	10	16	25	35	50	63	100	Z (-25°C) / Z (+20°C)	4	3	2	2	2	2	2	2	Z (-40°C) / Z (+20°C)	8	6	4	4	3	3	3	3
WV (V)	6.3	10	16	25	35	50	63	100																				
Z (-25°C) / Z (+20°C)	4	3	2	2	2	2	2	2																				
Z (-40°C) / Z (+20°C)	8	6	4	4	3	3	3	3																				
Endurance	After the WV has been applied at 105°C for 2000 hours, the capacitors shall meet following requirements. (a) Capacitance Change: Within ±25% of the Initial Value for 4ø to 6.3ø Within ±20% of the Initial Value for 8ø to 10ø (b) Dissipation Factor: Not Exceeding 200% of Specified Value (c) Leakage Current: Not Exceeding the Specified Value																											
Shelf Life	After having been placed at 105°C without voltage applied for 1000 hours, the capacitors shall meet the same requirements as Endurance.																											

## DIMENSIONS

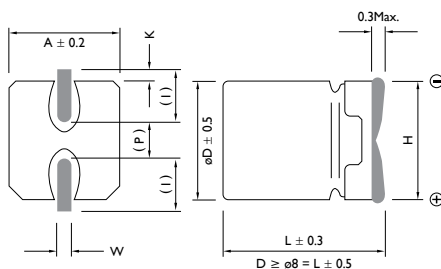

( ) Reference Size

Unit: mm

SIZE CODE	Dø	L	A	H	I	W	P	K
B	4.0	5.4	4.3	5.5 Max.	1.8	0.65 ± 0.1	1.0 ± 0.2	0.35 <sup>+ 0.15</sup> <sub>- 0.20</sub>
C	5.0	5.4	5.3	6.5 Max.	2.2	0.65 ± 0.1	1.5 ± 0.2	0.35 <sup>+ 0.15</sup> <sub>- 0.20</sub>
D	6.3	5.4	6.6	7.8 Max.	2.6	0.65 ± 0.1	1.8 ± 0.2	0.35 <sup>+ 0.15</sup> <sub>- 0.20</sub>
E	8.0	6.5	8.3	9.5 Max.	3.4	0.65 ± 0.1	2.2 ± 0.2	0.35 <sup>+ 0.15</sup> <sub>- 0.20</sub>
F	8.0	10.5	8.3	10.0 Max.	3.4	0.90 ± 0.2	3.1 ± 0.2	0.70 ± 0.20
G	10.0	10.5	10.3	12.0 Max.	3.5	0.90 ± 0.2	4.6 ± 0.2	0.70 ± 0.20
H	6.3	7.7	6.6	7.8 Max.	2.6	0.65 ± 0.1	1.8 ± 0.2	0.35 <sup>+ 0.15</sup> <sub>- 0.20</sub>

**CASE SIZE & PERMISSIBLE RIPPLE CURRENT OF STANDARD PRODUCTS**

D x L: mm

CAP. (μF)	RATED VOLTAGE WV (SURGE VOLTAGE WV)								
	6.3 (8)			10 (13)			16 (20)		
	SIZE	RIPPLE CURRENT	DISSIPATION FACTOR	SIZE	RIPPLE CURRENT	DISSIPATION FACTOR	SIZE	RIPPLE CURRENT	DISSIPATION FACTOR
4.7							4 x 5.4	20	0.16
10							4 x 5.4	28	0.16
22	5 x 5.4	29	0.30	5 x 5.4	36	0.22	5 x 5.4	39	0.16
33	5 x 5.4	43	0.30	5 x 5.4	45	0.22	6.3 x 5.4	65	0.16
47	5 x 5.4	44	0.30	6.3 x 5.4	70	0.22	6.3 x 5.4	70	0.16
	6.3 x 5.4	46	0.30				6.3 x 7.7	80	0.16
100	6.3 x 5.4	71	0.30	6.3 x 5.4	85	0.30	6.3 x 5.4	100	0.20
				6.3 x 7.7	104	0.30	6.3 x 7.7	130	0.20
				8 x 6.5	110	0.30	8 x 10.5	140	0.20
220	6.3 x 7.7	115	0.35	6.3 x 7.7	105	0.30	10 x 10.5	210	0.20
	8 x 10.5	150	0.35	8 x 10.5	160	0.30			
330	8 x 10.5	230	0.35	8 x 10.5	190	0.30	10 x 10.5	230	0.20
				10 x 10.5	230	0.26			
470	8 x 10.5	260	0.35	10 x 10.5	270	0.26	10 x 10.5	275	0.20
	10 x 10.5	260	0.35						
1000	10 x 10.5	380	0.35	10 x 10.5	390	0.26			

Note: 1. Ripple Current: (mA/rms) 105°C, 120Hz

2. Dissipation Factor: 20°C, 120Hz



## CASE SIZE & PERMISSIBLE RIPPLE CURRENT OF STANDARD PRODUCTS

D × L: mm

CAP. (μF)	RATED VOLTAGE WV (SURGE VOLTAGE WV)								
	25 (32)			35 (44)			50 (63)		
	SIZE	RIPPLE CURRENT	DISSIPATION FACTOR	SIZE	RIPPLE CURRENT	DISSIPATION FACTOR	SIZE	RIPPLE CURRENT	DISSIPATION FACTOR
0.10							4 × 5.4	1	0.12
0.22							4 × 5.4	2	0.12
0.33							4 × 5.4	3	0.12
0.47							4 × 5.4	5	0.12
1.0							4 × 5.4	10	0.12
2.2							4 × 5.4	16	0.12
3.3							4 × 5.4	16	0.12
4.7	4 × 5.4	22	0.14	5 × 5.4	23	0.12	4 × 5.4	18	0.12
							5 × 5.4	23	0.12
6.8	4 × 5.4	25	0.14	5 × 5.4	27	0.12	5 × 5.4	30	0.12
10	5 × 5.4	28	0.14	5 × 5.4	30	0.12	5 × 5.4	35	0.12
22	6.3 × 5.4	55	0.14	6.3 × 5.4	60	0.14	8 × 10.5	70	0.12
33	6.3 × 5.4	65	0.14	6.3 × 7.7	79	0.14	8 × 10.5	91	0.12
				8 × 6.5	84	0.14			
47	6.3 × 5.4	70	0.16	8 × 10.5	98	0.14	10 × 10.5	100	0.12
	6.3 × 7.7	86	0.16						
	8 × 6.5	91	0.16						
100	6.3 × 7.7	90	0.16	10 × 10.5	160	0.14	10 × 10.5	145	0.12
	8 × 10.5	130	0.16						
220	8 × 10.5	220	0.16	10 × 10.5	240	0.14	10 × 10.5	200	0.12
	10 × 10.5	273	0.16						
330	10 × 10.5	334	0.16						
470	10 × 10.5	300	0.16						

Note: 1. Ripple Current: (mA/rms) 105°C, 120Hz

2. Dissipation Factor: 20°C, 120Hz

**CASE SIZE & PERMISSIBLE RIPPLE CURRENT OF STANDARD PRODUCTS**

D x L: mm

CAP. (μF)	RATED VOLTAGE WV (SURGE VOLTAGE WV)					
	63 (79) SIZE			100 (125) SIZE		
		RIPPLE CURRENT	DISSIPATION FACTOR		RIPPLE CURRENT	DISSIPATION FACTOR
3.3				8 x 10.5	30	0.18
4.7	8 x 10.5	25	0.18	8 x 10.5	80	0.18
10	8 x 10.5	25	0.18	8 x 10.5	85	0.18
22	10 x 10.5	45	0.18	10 x 10.5	85	0.18
33	10 x 10.5	45	0.18	10 x 10.5	90	0.18
47	10 x 10.5	55	0.18			

Note: 1. Ripple Current: (mA/rms) 105°C, 120Hz

2. Dissipation Factor: 20°C, 120Hz

# Surface Mount Aluminum Electrolytic

# CZ [ For Low Impedance ]



## FEATURE

For Low ESR Series with 105°C 1000 Hours

Suitable for AV (TV, Video, Audio), Monitor / Computer, Battery Charger, DC / DC Converter, SMPS, Noise Filter

## MARKING

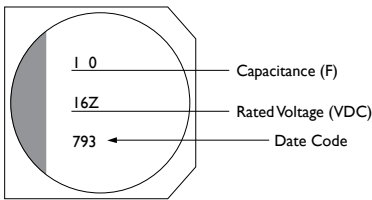

## ELECTRICAL CHARACTERISTICS

Operation Temperature Range	-40 to +105°C							
Rated Voltage Range	4 to 50VDC							
Rated Capacitance Range	0.1 ~ 1000μF							
Capacitance Tolerance	±20% at 120Hz, 20°C							
Leakage Current (Max.20°C)	$I \leq 0.01CV$ (μA) or 3μA (After 2 Minutes Application of DC Rated Voltage at 20°C) I = Leakage Current (μA), C = Rated Capacitance (μF), V = Rated Voltage (V)							
Low Temperature Stability	Impedance Ratio at 120Hz							
	WV (V)	4	6.3	10	16	25	35	50
	Z (-25°C) / Z (+20°C)	4	2	2	2	2	2	2
	Z (-40°C) / Z (+20°C)	8	4	4	3	3	3	3
Endurance	After 1000 hours application of WV at 105°C, the capacitors shall meet following requirements. (a) Capacitance Change: Within ±20% of the Initial Value (b) Dissipation Factor: Not Exceeding 200% of Specified Value (c) Leakage Current: Not Exceeding the Specified Value							
Shelf Life	After having been placed at 105°C without voltage applied for 1000 hours, the capacitors shall meet the same requirements as Endurance.							

## DIMENSIONS

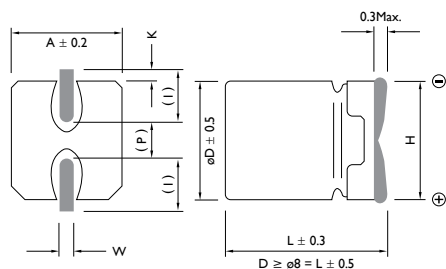

( ) Reference Size

Unit: mm

SIZE CODE	Dø	L	A	H	I	W	P	K
B	4.0	5.4	4.3	5.5 Max.	1.8	0.65 ± 0.1	1.0 ± 0.2	0.35 <sup>+0.15</sup> <sub>-0.20</sub>
C	5.0	5.4	5.3	6.5 Max.	2.2	0.65 ± 0.1	1.5 ± 0.2	0.35 <sup>+0.15</sup> <sub>-0.20</sub>
D	6.3	5.4	6.6	7.8 Max.	2.6	0.65 ± 0.1	1.8 ± 0.2	0.35 <sup>+0.15</sup> <sub>-0.20</sub>
E	8.0	6.5	8.3	9.5 Max.	3.4	0.65 ± 0.1	2.2 ± 0.2	0.35 <sup>+0.15</sup> <sub>-0.20</sub>
F	8.0	10.5	8.3	10.0 Max.	3.4	0.90 ± 0.2	3.1 ± 0.2	0.70 ± 0.20
G	10.0	10.5	10.3	12.0 Max.	3.5	0.90 ± 0.2	4.6 ± 0.2	0.70 ± 0.20
H	6.3	7.7	6.6	7.8 Max.	2.6	0.65 ± 0.1	1.8 ± 0.2	0.35 <sup>+0.15</sup> <sub>-0.20</sub>



**CASE SIZE & PERMISSIBLE RIPPLE CURRENT OF STANDARD PRODUCTS**

D x L: mm

CAP. (μF)	RATED VOLTAGE WV (SURGE VOLTAGE WV)							
	4 (5) SIZE				6.3 (8) SIZE			
	SIZE	RIPPLE CURRENT	DISSIPATION FACTOR	ESR	SIZE	RIPPLE CURRENT	DISSIPATION FACTOR	ESR
4.7	4 x 5.4	60	0.35	4.00				
6.8	4 x 5.4	60	0.35	4.00				
10	4 x 5.4	60	0.35	4.00				
22	4 x 5.4	60	0.35	4.00	4 x 5.4	60	0.26	4.00
33	4 x 5.4	60	0.35	4.00	5 x 5.4	95	0.26	2.60
47	4 x 5.4	60	0.35	4.00	5 x 5.4	95	0.26	2.60
68	4 x 5.4	60	0.35	4.00	6.3 x 5.4	140	0.26	1.30
100	5 x 5.4	95	0.35	3.00	6.3 x 5.4	140	0.26	1.30
150	6.3 x 5.4	140	0.35	2.60	8 x 6.5	230	0.35	0.80
220	6.3 x 5.4	140	0.35	2.60	8 x 6.5	230	0.35	0.80
330					8 x 10.5	450	0.35	0.50
470					10 x 10.5	670	0.35	0.30
1000					10 x 10.5	670	0.35	0.30

Note: 1. Ripple Current: (mA/rms) 105°C, 100KHz

2. Dissipation Factor: 20°C, 120Hz

3. ESR: 20°C, 100KHz (Ω)



## CASE SIZE & PERMISSIBLE RIPPLE CURRENT OF STANDARD PRODUCTS

D x L: mm

CAP. (μF)	RATED VOLTAGE WV (SURGE VOLTAGE WV)							
	10 (13) SIZE				16 (20) SIZE			
	SIZE	RIPPLE CURRENT	DISSIPATION FACTOR	ESR	SIZE	RIPPLE CURRENT	DISSIPATION FACTOR	ESR
4.7					4 × 5.4	60	0.16	4.00
6.8					4 × 5.4	60	0.16	4.00
10	4 × 5.4	60	0.22	4.00	4 × 5.4	60	0.16	4.00
22	5 × 5.4	95	0.22	2.60	5 × 5.4	95	0.16	2.60
33	5 × 5.4	95	0.22	2.60	5 × 5.4	95	0.16	2.60
47	6.3 × 5.4	95	0.22	1.30	6.3 × 5.4	140	0.16	1.30
68	6.3 × 5.4	140	0.22	1.30	8 × 6.5	230	0.20	0.80
100	6.3 × 5.4	140	0.22	1.30	8 × 6.5	230	0.20	0.80
150	8 × 6.5	230	0.26	0.80	10 × 10.5	450	0.20	0.50
220	8 × 6.5	230	0.26	0.80	10 × 10.5	450	0.20	0.50
330	8 × 10.5	450	0.26	0.50	10 × 10.5	670	0.20	0.30
470	10 × 10.5	670	0.26	0.30	10 × 10.5	670	0.20	0.30
1000	10 × 10.5	670	0.26	0.30				

Note: 1. Ripple Current: (mA/rms) 105°C, 100KHz

2. Dissipation Factor: 20°C, 120Hz

3. ESR: 20°C, 100KHz (Ω)

**CASE SIZE & PERMISSIBLE RIPPLE CURRENT OF STANDARD PRODUCTS**

D x L: mm

CAP. ( $\mu$ F)	RATED VOLTAGE WV (SURGE VOLTAGE WV)												
	25 (32)				35 (44)				50 (63)				
	SIZE	RIPPLE CURRENT	DISSIPATION FACTOR	ESR	SIZE	RIPPLE CURRENT	DISSIPATION FACTOR	ESR	SIZE	RIPPLE CURRENT	DISSIPATION FACTOR	ESR	
0.10									4 x 5.4	60		0.12	5.00
0.22									4 x 5.4	60		0.12	5.00
0.33									4 x 5.4	60		0.12	5.00
0.47									4 x 5.4	60		0.12	5.00
1.0					4 x 5.4	60	0.12	4.00	4 x 5.4	60		0.12	5.00
2.2					4 x 5.4	60	0.12	4.00	4 x 5.4	60		0.12	5.00
3.3					4 x 5.4	60	0.12	4.00	4 x 5.4	60		0.12	5.00
4.7	4 x 5.4	60	0.14	4.00	4 x 5.4	60	0.12	4.00	5 x 5.4	95		0.12	4.00
6.8	4 x 5.4	60	0.14	4.00	5 x 5.4	95	0.12	2.60	6.3 x 5.4	140		0.12	2.60
10	5 x 5.4	95	0.14	2.60	5 x 5.4	95	0.12	2.60	6.3 x 5.4	140		0.12	2.60
22	6.3 x 5.4	140	0.14	1.30	6.3 x 5.4	140	0.12	1.30	8 x 6.5	230		0.12	1.30
33	6.3 x 5.4	140	0.14	1.30	8 x 6.5	230	0.14	0.80	8 x 10.5	300		0.12	1.10
47	6.3 x 5.4	140	0.14	1.30	8 x 6.5	230	0.14	0.80	10 x 10.5	670		0.12	0.80
68	8 x 10.5	450	0.16	0.50	8 x 10.5	450	0.14	0.50	10 x 10.5	670		0.12	0.80
100	8 x 10.5	450	0.16	0.50	10 x 10.5	670	0.14	0.30	10 x 10.5	670		0.12	0.80
150	10 x 10.5	670	0.16	0.30	10 x 10.5	670	0.14	0.30					
220	10 x 10.5	670	0.16	0.30	10 x 10.5	670	0.14	0.30					

Note: 1. Ripple Current: (mA/rms) 105°C, 100KHz

2. Dissipation Factor: 20°C, 120Hz

3. ESR: 20°C, 100KHz ( $\Omega$ )

# Surface Mount Aluminum Electrolytic

# CD [ For Ultra Low Impedance ]



## FEATURE

For Ultra Low Impedance Series with 105°C 2000 Hours  
Suitable for AV (TV, Video, Audio), Monitor / Computer,  
OA / HA / Communication, SMPS

## MARKING

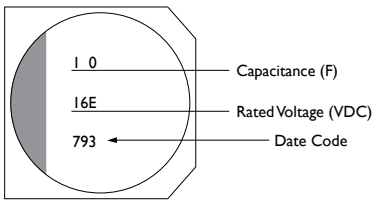

## DIMENSIONS

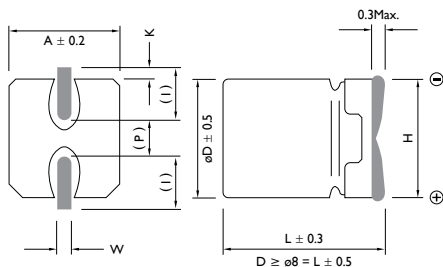

( ) Reference Size

## ELECTRICAL CHARACTERISTICS

Operation Temperature Range	-40 to +105°C					
Rated Voltage Range	6.3 to 35VDC					
Rated Capacitance Range	4.7 ~ 1500µF					
Capacitance Tolerance	±20% at 120Hz, 20°C					
Leakage Current (Max. 20°C)	I ≤ 0.01CV (µA) or 3µA (After 2 Minutes Application of DC Rated Voltage at 20°C) I = Leakage Current (µA), C = Rated Capacitance (µF), V = Rated Voltage (V)					
Dissipation Factor (tanδ) (120Hz, 20°C)	WV(V)	6.3	10	16	25	35
	tan δ	0.26	0.19	0.16	0.14	0.12
Low Temperature Stability	Impedance Ratio at 120Hz					
	WV (V)	6.3	10	16	25	35
	Z (-25°C) / Z (+20°C)	2	2	2	2	2
	Z (-40°C) / Z (+20°C)	3	3	3	3	3
Endurance	After the WV has been applied at 105°C for 2000 hours, the capacitors shall meet following requirements. (a) Capacitance Change: Within ±30% of the Initial Value (b) Dissipation Factor: Not Exceeding 200% of Specified Value (c) Leakage Current: Not Exceeding the Specified Value					
Shelf Life	After having been placed at 105°C without voltage applied for 1000 hours, the capacitors shall meet the same requirements as Endurance.					

Unit: mm

SIZE CODE	Dø	L	A	H	I	W	P	K
B	4.0	5.4	4.3	5.5 Max.	1.8	0.65 ± 0.1	1.0 ± 0.2	0.35 <sup>+ 0.15</sup> <sub>- 0.20</sub>
C	5.0	5.4	5.3	6.5 Max.	2.2	0.65 ± 0.1	1.5 ± 0.2	0.35 <sup>+ 0.15</sup> <sub>- 0.20</sub>
D	6.3	5.4	6.6	7.8 Max.	2.6	0.65 ± 0.1	1.8 ± 0.2	0.35 <sup>+ 0.15</sup> <sub>- 0.20</sub>
E	8.0	6.5	8.3	9.5 Max.	3.4	0.65 ± 0.1	2.2 ± 0.2	0.35 <sup>+ 0.15</sup> <sub>- 0.20</sub>
F	8.0	10.5	8.3	10.0 Max.	3.4	0.90 ± 0.2	3.1 ± 0.2	0.70 ± 0.20
G	10.0	10.5	10.3	12.0 Max.	3.5	0.90 ± 0.2	4.6 ± 0.2	0.70 ± 0.20
H	6.3	7.7	6.6	7.8 Max.	2.6	0.65 ± 0.1	1.8 ± 0.2	0.35 <sup>+ 0.15</sup> <sub>- 0.20</sub>

## CASE SIZE & PERMISSIBLE RIPPLE CURRENT OF STANDARD PRODUCTS

D x L: mm

CAP. (μF)	RATED VOLTAGE WV (SURGE VOLTAGE WV)								
	6.3 (8) SIZE			10 (13) SIZE			16 (20) SIZE		
	SIZE	RIPPLE	ESR	SIZE	RIPPLE	ESR	SIZE	RIPPLE	ESR
22	4 x 5.4	90	1.93	4 x 5.4	90	1.93	4 x 5.4	90	1.93
							5 x 5.4	160	1.00
33	4 x 5.4	90	1.93	4 x 5.4	90	1.93	5 x 5.4	160	1.00
				5 x 5.4	160	1.00			
47	4 x 5.4	90	1.93	6.3 x 5.4	190	0.52	5 x 5.4	160	1.00
	5 x 5.4	160	1.00				6.3 x 5.4	240	0.52
100	5 x 5.4	160	1.00	6.3 x 5.4	190	0.52	6.3 x 5.4	240	0.52
	6.3 x 5.4	240	0.52						
150	8 x 6.5	240	0.30	6.3 x 7.7	240	0.34	6.3 x 7.7	280	0.34
220	8 x 6.5	240	0.30	6.3 x 7.7	280	0.34	6.3 x 7.7	330	0.34
				8 x 6.5	300	0.26	8 x 10.5	370	0.22
330	6.3 x 7.7	280	0.34	8 x 10.5	600	0.16	8 x 10.5	600	0.16
	8 x 6.5	300	0.26						
470	8 x 10.5	600	0.16	8 x 10.5	600	0.16	8 x 10.5	600	0.16
							10 x 10.5	600	0.08
680	8 x 10.5	600	0.16	10 x 10.5	600	0.12	10 x 10.5	850	0.08
820							10 x 10.5	850	0.08
1000	10 x 10.5	600	0.16						
1200	10 x 10.5	700	0.16						
1500	10 x 10.5	850	0.08						

Note: 1. Ripple Current: (mA/rms) 105°C, 100KHz

2. ESR: 100KHz / 20°C (Ω Max.)



## CASE SIZE & PERMISSIBLE RIPPLE CURRENT OF STANDARD PRODUCTS

D x L: mm

CAP. (μF)	RATED VOLTAGE WV (SURGE VOLTAGE WV)					
	25 (32) SIZE			35 (44) SIZE		
		RIPPLE	ESR		RIPPLE	ESR
4.7				4 x 5.4	90	1.93
10	4 x 5.4	90	1.93	4 x 5.4	90	1.93
				5 x 5.4	160	1.00
22	5 x 5.4	160	1.00	5 x 5.4	160	1.00
33	5 x 5.4	160	1.00	6.3 x 5.4	240	0.52
	6.3 x 5.4	240	0.52			
47	6.3 x 5.4	240	0.52	6.3 x 5.4	240	0.52
68	6.3 x 5.4	240	0.52	6.3 x 7.7	280	0.34
100	6.3 x 7.7	280	0.34	6.3 x 7.7	280	0.34
	8 x 6.5	300	0.26	8 x 10.5	600	0.16
				10 x 10.5	850	0.08
150	8 x 10.5	600	0.16	8 x 10.5	600	0.16
220	8 x 10.5	600	0.16	10 x 10.5	600	0.16
330	10 x 10.5	600	0.16	10 x 10.5	850	0.08
470	10 x 10.5	850	0.08			

Note: 1. Ripple Current: (mA/rms) 105°C, 100KHz

2. ESR: 100KHz / 20°C (Ω Max.)

# CH [ Ultra Low Impedance & High Temperature ]

125°C 2000 Hours, Ultra Low Impedance High Temperature

## Surface Mount Aluminum Electrolytic

### ELECTRICAL CHARACTERISTICS

Operation Temperature Range	-40 ~ +125°C																					
Rated Voltage Range	6.3 ~ 50VDC																					
Rated Capacitance Range	47 ~ 1000μF																					
Capacitance Tolerance	±20% at 120Hz, 20°C																					
Leakage Current (Max. 20°C)	$I \leq 0.01CV$ or $3\mu A$ (After Rated Voltage Applied for 2 Minutes) $I$ = Leakage Current ( $\mu A$ ), $C$ =Nominal Capacitance ( $\mu F$ ), $V$ =Rated Voltage (V)																					
Dissipation Factor (Max.) (tan $\delta$ ) (120Hz, 20°C)	Shown in the table of standard rating																					
Low Temperature Stability	Impedance Ratio (Max.) <table border="1" style="margin-left: 20px;"> <tr> <td>WV (V):</td> <td>6.3</td> <td>10</td> <td>16</td> <td>25</td> <td>35</td> <td>50</td> </tr> <tr> <td>Z-25°C/Z+20°C:</td> <td>2</td> <td>2</td> <td>2</td> <td>2</td> <td>2</td> <td>2</td> </tr> <tr> <td>Z-40°C/Z+20°C:</td> <td>3</td> <td>3</td> <td>3</td> <td>3</td> <td>3</td> <td>3</td> </tr> </table>	WV (V):	6.3	10	16	25	35	50	Z-25°C/Z+20°C:	2	2	2	2	2	2	Z-40°C/Z+20°C:	3	3	3	3	3	3
WV (V):	6.3	10	16	25	35	50																
Z-25°C/Z+20°C:	2	2	2	2	2	2																
Z-40°C/Z+20°C:	3	3	3	3	3	3																
Endurance	After the rated voltage has been applied at 125°C for 1000~2000 hours, the capacitors shall meet the following requirements. (a) Capacitance Change: Within ±30% of the Initial Value (b) Dissipation Factor: Not Exceeding 300% of Specified Value (c) Leakage Current: Not Exceeding the Specified Value <table border="1" style="margin-left: 20px;"> <tr> <td>D<math>\phi</math>:</td> <td><math>8 \times 6.5\phi</math></td> <td><math>\geq 8 \times 10.5\phi</math></td> </tr> <tr> <td>Load Life:</td> <td>1000hrs</td> <td>2000hrs</td> </tr> </table>	D $\phi$ :	$8 \times 6.5\phi$	$\geq 8 \times 10.5\phi$	Load Life:	1000hrs	2000hrs															
D $\phi$ :	$8 \times 6.5\phi$	$\geq 8 \times 10.5\phi$																				
Load Life:	1000hrs	2000hrs																				
Shelf Life	After having been placed at 125°C without voltage applied for 1000 hours (500 hours for $8 \times 6.5$ ), the capacitors shall meet the same requirements as Endurance.																					

### DIAGRAM OF DIMENSIONS

D $\phi$	L	A	H	I	W	P	K
8.0	6.5	8.3	9.5 Max.	3.4	0.65 ± 0.1	2.2 ± 0.2	0.35 <sup>+0.15</sup> <sub>-0.75</sub>
8.0	10.5	8.3	10.0 Max.	3.4	0.90 ± 0.2	3.1 ± 0.2	0.70 ± 0.2
10.0	10.5	10.3	12.0 Max.	3.5	0.90 ± 0.2	4.6 ± 0.2	0.70 ± 0.2



### FEATURE

125°C 2,000 hours, higher temperature range, low profile vertical chip, low impedance

Applications: Automatic Mounting and Reflow Soldering

### MULTIPLIER FOR RIPPLE CURRENT

Frequency Coefficient

FREQUENCY (Hz)	120	1K	10K	100K
COEFFICIENT	0.70	0.80	0.90	1.00

Dimensions: mm

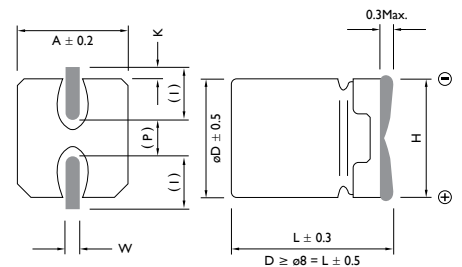

( ) Reference Size



## CASE SIZE & PERMISSIBLE RIPPLE CURRENT OF STANDARD PRODUCTS

D x L: mm

CAP. ( $\mu$ F)	RATED VOLTAGE WV (SURGE VOLTAGE WV)											
	6.3 (8)				10 (13)				16 (20)			
	SIZE	RIPPLE CURRENT	DISSIPATION FACTOR	ESR	SIZE	RIPPLE CURRENT	DISSIPATION FACTOR	ESR	SIZE	RIPPLE CURRENT	DISSIPATION FACTOR	ESR
100	8 x 6.5	100	0.30	0.50	8 x 6.5	100	0.26	0.50	8 x 6.5	100	0.20	0.50
150	8 x 6.5	100	0.30	0.50	8 x 6.5	100	0.26	0.50	8 x 10.5	197	0.20	0.30
220	8 x 6.5	100	0.30	0.50	8 x 10.5	197	0.26	0.30	8 x 10.5	197	0.20	0.30
330	8 x 10.5	197	0.30	0.30	8 x 10.5	197	0.26	0.30	8 x 10.5	197	0.20	0.30
470	8 x 10.5	197	0.30	0.30	10 x 10.5	297	0.26	0.20	10 x 10.5	297	0.20	0.20
680	10 x 10.5	297	0.30	0.20	10 x 10.5	297	0.26	0.20				
1000	10 x 10.5	297	0.30	0.20								

Note: 1. Ripple Current: (mA/rms) 125°C, 100KHz

2. Dissipation Factor: 20°C, 120Hz

3. ESR: 100KHz / 20°C ( $\Omega$  Max.)



**CASE SIZE & PERMISSIBLE RIPPLE CURRENT OF STANDARD PRODUCTS**

D x L: mm

CAP. ( $\mu$ F)	RATED VOLTAGE WV (SURGE VOLTAGE WV)											
	25 (32)				35 (44)				50 (63)			
	SIZE	RIPPLE CURRENT	DISSIPATION FACTOR	ESR	SIZE	RIPPLE CURRENT	DISSIPATION FACTOR	ESR	SIZE	RIPPLE CURRENT	DISSIPATION FACTOR	ESR
47	8 x 6.5	100	0.18	0.50	8 x 10.5	197	0.14	0.30	8 x 10.5	133	0.12	0.75
100	8 x 10.5	197	0.18	0.30	8 x 10.5	197	0.14	0.30	10 x 10.5	221	0.12	0.50
150	8 x 10.5	197	0.18	0.30	10 x 10.5	297	0.14	0.20				
220	10 x 10.5	297	0.18	0.20	10 x 10.5	297	0.14	0.20				
330	10 x 10.5	297	0.18	0.20								

Note: 1. Ripple Current: (mA/rms) 125°C, 100KHz

2. Dissipation Factor: 20°C, 120Hz

3. ESR: 100KHz / 20°C ( $\Omega$  Max.)

# Surface Mount Aluminum Electrolytic

# CX [ Ultra Low Impedance and Long Life ]

105°C 3000 ~ 5000 Hours, Ultra Low Impedance Long Life



## FEATURE

105°C 3,000~5,000 hours, low profile vertical chip, ultra low impedance

Applications: AV(TV,Video, Audio), Monitor/Computer, OA/HA/Communication, SMPS

### MULTIPLIER FOR RIPPLE CURRENT

Frequency Coefficient

FREQUENCY (Hz)	120	1K	10K	100K
COEFFICIENT	0.70	0.80	0.90	1.00

## ELECTRICAL CHARACTERISTICS

Operation Temperature Range	-40 ~ +105°C																					
Rated Voltage Range	6.3 ~ 50VDC																					
Rated Capacitance Range	1 ~ 1000μF																					
Capacitance Tolerance	±20% at 120Hz, 20°C																					
Leakage Current (Max. 20°C)	$I \leq 0.01 CV$ or $3\mu A$ (After Rated Voltage Applied for 2 Minutes) I = Leakage Current (μA), C = Nominal Capacitance (μF), V = Rated Voltage (V)																					
Dissipation Factor (Max.) (tanδ) (20°C, 120Hz)	Shown in the table of standard rating																					
Low Temperature Stability	Impedance Ratio (Max.) <table border="1"> <thead> <tr> <th>WV (V) :</th> <th>6.3</th> <th>10</th> <th>16</th> <th>25</th> <th>35</th> <th>50</th> </tr> </thead> <tbody> <tr> <td>Z-25°C/Z+20°C :</td> <td>2</td> <td>2</td> <td>2</td> <td>2</td> <td>2</td> <td>2</td> </tr> <tr> <td>Z-40°C/Z+20°C :</td> <td>3</td> <td>3</td> <td>3</td> <td>3</td> <td>3</td> <td>3</td> </tr> </tbody> </table>	WV (V) :	6.3	10	16	25	35	50	Z-25°C/Z+20°C :	2	2	2	2	2	2	Z-40°C/Z+20°C :	3	3	3	3	3	3
WV (V) :	6.3	10	16	25	35	50																
Z-25°C/Z+20°C :	2	2	2	2	2	2																
Z-40°C/Z+20°C :	3	3	3	3	3	3																
Endurance	After the rated voltage has been applied at 155°C for 3000~5000 hours, the capacitors shall meet the following requirements. (a) Capacitance Change: Within ±30% of Initial Value (b) Dissipation Factor: Not Exceeding 200% of the Specified Value (c) Leakage Current: Initial Specified Value or Less <table border="1"> <thead> <tr> <th>Dø :</th> <th>4 × 5.4~8 × 6.5ø</th> <th>≥8 × 10.5~10 × 10.5ø</th> </tr> </thead> <tbody> <tr> <td>Load Life :</td> <td>3000hrs</td> <td>5000hrs</td> </tr> </tbody> </table>	Dø :	4 × 5.4~8 × 6.5ø	≥8 × 10.5~10 × 10.5ø	Load Life :	3000hrs	5000hrs															
Dø :	4 × 5.4~8 × 6.5ø	≥8 × 10.5~10 × 10.5ø																				
Load Life :	3000hrs	5000hrs																				
Shelf Life	After having been placed at 105°C without voltage applied for 1000 hours, the capacitors shall meet the same requirements as Endurance.																					

## DIMENSIONS

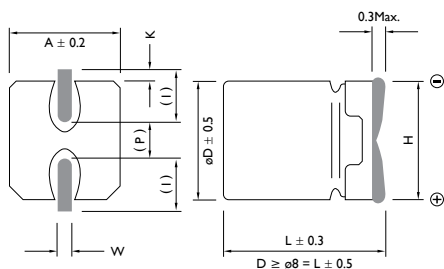

( ) Reference Size

Unit: mm

Dø	L	A	H	I	W	P	K
4.0	5.4	4.3	5.5 Max.	1.8	0.65 ± 0.1	1.0 ± 0.2	0.35 <sup>+0.15</sup> <sub>-0.20</sub>
5.0	5.4	5.3	6.5 Max.	2.2	0.65 ± 0.1	1.5 ± 0.2	0.35 <sup>+0.15</sup> <sub>-0.20</sub>
6.3	5.4	6.6	7.8 Max.	2.6	0.65 ± 0.1	1.8 ± 0.2	0.35 <sup>+0.15</sup> <sub>-0.20</sub>
6.3	7.7	6.6	7.8 Max.	2.6	0.65 ± 0.1	1.8 ± 0.2	0.35 <sup>+0.15</sup> <sub>-0.20</sub>
8.0	6.5	8.3	9.5 Max.	3.4	0.65 ± 0.1	2.2 ± 0.2	0.35 <sup>+0.15</sup> <sub>-0.20</sub>
8.0	10.5	8.3	10.0 Max.	3.4	0.90 ± 0.2	3.1 ± 0.2	0.70 ± 0.20
10.0	10.5	10.3	12.0 Max.	3.5	0.90 ± 0.2	4.6 ± 0.2	0.70 ± 0.20

**CASE SIZE & PERMISSIBLE RIPPLE CURRENT OF STANDARD PRODUCTS**

D x L: mm

CAP. ( $\mu$ F)	RATED VOLTAGE WV (SURGE VOLTAGE WV)											
	6.3 (8)				10 (13)				16 (20)			
	SIZE	RIPPLE CURRENT	DISSIPATION FACTOR	ESR	SIZE	RIPPLE CURRENT	DISSIPATION FACTOR	ESR	SIZE	RIPPLE CURRENT	DISSIPATION FACTOR	ESR
22	4 x 5.4	90	0.26	1.93	4 x 5.4	90	0.19	1.93	5 x 5.4	160	0.16	1.00
33	4 x 5.4	90	0.26	1.93	5 x 5.4	160	0.19	1.00	6.3 x 5.4	240	0.16	0.52
47	5 x 5.4	160	0.26	1.00	6.3 x 5.4	190	0.19	0.52	6.3 x 5.4	240	0.16	0.52
100	6.3 x 5.4	240	0.26	0.52	6.3 x 5.4	190	0.19	0.52	6.3 x 7.7	280	0.16	0.34
150	8 x 6.5	240	0.26	0.30	6.3 x 7.7	240	0.19	0.34	8 x 10.5	370	0.16	0.22
220	8 x 6.5	240	0.26	0.30	8 x 10.5	600	0.19	0.16	8 x 10.5	370	0.16	0.22
330	8 x 10.5	600	0.26	0.16	8 x 10.5	600	0.19	0.16	8 x 10.5	600	0.16	0.16
470	8 x 10.5	600	0.26	0.16	10 x 10.5	850	0.19	0.12	10 x 10.5	850	0.16	0.12
680	10 x 10.5	850	0.26	0.12	10 x 10.5	850	0.19	0.12				
1000	10 x 10.5	850	0.26	0.12								

Note: 1. Ripple Current: (mA/rms) 105°C, 100KHz

2. Dissipation Factor: 20°C, 120Hz

3. ESR: 100KHz / 20°C ( $\Omega$  Max.)



## CASE SIZE & PERMISSIBLE RIPPLE CURRENT OF STANDARD PRODUCTS

D x L: mm

CAP. ( $\mu$ F)	RATED VOLTAGE WV (SURGE VOLTAGE WV)											
	25 (32)				35 (44)				50 (63)			
	SIZE	RIPPLE CURRENT	DISSIPATION FACTOR	ESR	SIZE	RIPPLE CURRENT	DISSIPATION FACTOR	ESR	SIZE	RIPPLE CURRENT	DISSIPATION FACTOR	ESR
1.0									4 x 5.4	60	0.12	5.00
2.2									4 x 5.4	60	0.12	5.00
3.3									4 x 5.4	60	0.12	5.00
4.7					4 x 5.4	90	0.12	1.93	5 x 5.4	95	0.12	4.00
10	4 x 5.4	90	0.14	1.93	5 x 5.4	160	0.12	1.00	6.3 x 5.4	140	0.12	2.60
22	5 x 5.4	160	0.14	1.00	5 x 5.4	160	0.12	1.00	8 x 6.5	230	0.12	1.30
33	6.3 x 5.4	240	0.14	0.52	6.3 x 5.4	240	0.12	0.52	8 x 10.5	350	0.12	0.50
47	6.3 x 5.4	240	0.14	0.52	6.3 x 7.7	280	0.12	0.34	10 x 10.5	670	0.12	0.34
68	6.3 x 7.7	280	0.14	0.34	6.3 x 7.7	280	0.12	0.34	10 x 10.5	670	0.12	0.34
100	8 x 6.5	300	0.14	0.26	8 x 10.5	600	0.12	0.16	10 x 10.5	670	0.12	0.34
150	8 x 10.5	600	0.14	0.16	10 x 10.5	850	0.12	0.12				
220	8 x 10.5	600	0.14	0.16	10 x 10.5	850	0.12	0.12				
330	10 x 10.5	850	0.14	0.12								

Note: 1. Ripple Current: (mA/rms) 105°C, 100KHz

2. Dissipation Factor: 20°C, 120Hz

3. ESR: 100KHz / 20°C ( $\Omega$  Max.)

# CP [ Ultra Low ESR & High Ripple Current ]

105°C, 2000 Hours 8mm Height and Ultra Low ESR

## Conductive Polymer Solid Capacitors

### ELECTRICAL CHARACTERISTICS

Operation Temperature Range	-55 ~ +105°C	
Rated Voltage Range	2.5 ~ 6.3VDC	
Rated Capacitance Range	470 ~ 820μF	
Capacitance Tolerance	± 20% at 120Hz, 20°C	
Leakage Current (Max. 20°C)	I ≤ 0.2CV (μA) ( After Rated Voltage Applied for 2 Minutes ) I = Leakage Current (μA), C = Rated Capacitance (μF), V = Rated Voltage (V)	
Dissipation Factor at 120Hz, 20°C	WV(V)	2.5 ~ 6.3V
	D.F (%)	8
Low Temperature Stability	Impedance Ratio at 20°C (Max.)	
	WV (V)	2.5 ~ 16V (Rated Voltage)
	Impedance	Z - 25°C / Z + 20°C ≤ 1.15 Z - 55°C / Z + 20°C ≤ 1.25
Endurance	After the rated voltage has been applied at 105°C for 2000 hours, the capacitors shall meet the follow requirements.	
	(a) Appearance: No Significant Damage	
	(b) Capacitance Change: Within ±20% of the Initial Value	
	(c) Dissipation Factor: Not Exceeding 150% of the Initial Specified Value	
	(d) Equivalent Series Resistance: Not Exceeding 150% of the Initial Specified Value	
Humidity Test	After subjected 90 to 95% RH for 1000 hours at 60°C, the capacitors shall meet the requirements as Endurance.	



### DESCRIPTION

Recommended Applications: Motherboard, DC / DC Converter, DSC, PDA, HD Drive, MO Drive, DVD Drive, Navigation system, Portable Communication Devices

### DIAGRAM OF DIMENSIONS

Unit: mm

Rubber Stand-off

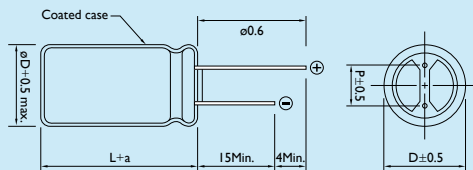

Dø	P	a (Max.)
8	3.5	1.5

### MARKING

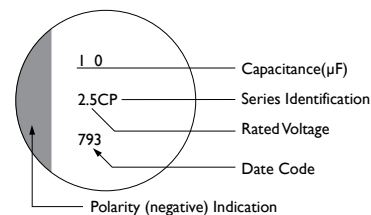



## CASE SIZE & PERMISSIBLE RIPPLE CURRENT OF STANDARD PRODUCTS

D x L: mm

CAP. (μF)	RATED VOLTAGE WV								
	2.5			4			6.3		
	SIZE	RIPPLE	ESR	SIZE	RIPPLE	ESR	SIZE	RIPPLE	ESR
470							8 x 8	4400	8
560	8 x 8	4400	6	8 x 8	4400	7	8 x 8	4400	8
820	8 x 8	4400	6						

Note: 1. Ripple Current: (mA/rms) 105°C, 100KHz

2. ESR: 100KHz / 20°C (mΩ)

# CG [ Low ESR & High Ripple Current ]

105°C, 2000 Hours and Ultra Low ESR

## Conductive Polymer Solid Capacitors

### ELECTRICAL CHARACTERISTICS

Operation Temperature Range	-55 ~ +105°C	
Rated Voltage Range	2.5 ~ 25VDC	
Rated Capacitance Range	33 ~ 2700μF	
Capacitance Tolerance	± 20% at 120Hz, 20°C	
Leakage Current (Max. 20°C)	I ≤ 0.2CV (μA) ( After Rated Voltage Applied for 2 Minutes ) I = Leakage Current (μA), C = Rated Capacitance (μF), V = Rated Voltage (V)	
Dissipation Factor at 120Hz, 20°C	WV(V)      2.5 ~ 10V	16 ~ 25
	D.F (%)      8	12
Low Temperature Stability	Impedance Ratio at 20°C (Max.)	
	WV (V)      2.5 ~ 16V	
	Impedance    Z - 25°C / Z + 20°C	≤ 1.15
	Z - 55°C / Z + 20°C	≤ 1.25 (Z: 100KHz)
Endurance	After the rated voltage has been applied at 105°C for 2000 hours, the capacitors shall meet the follow requirements. (a) Appearance: No Significant Damage (b) Capacitance Change: Within ±20% of Initial Value (c) Dissipation Factor: Not Exceeding 150% of the Initial Specified Value (d) Equivalent Series Resistance: Not Exceeding 150% of the Initial Specified Value (e) Leakage Current: Not Exceeding the Initial Specified Value	
Humidity Test	After subjected to 90 to 95% RH for 1000 hours at 60°C, the capacitors shall meet the requirements as Endurance.	



### DESCRIPTION

Long life for 2000 hours at 105°C, ideally suited for high quality and high reliability applications.

Featuring high CV products

### DIAGRAM OF DIMENSIONS

Unit: mm

Rubber Stand-off

Dø	P	a (Max.)
6	2.5	1.0
8	3.5	
10	5.0	

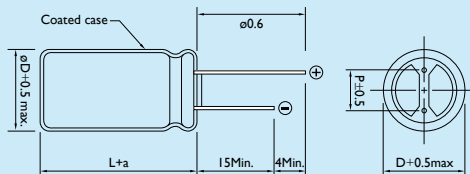

### MARKING

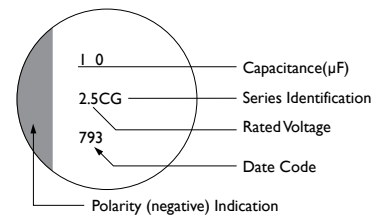



## CASE SIZE & PERMISSIBLE RIPPLE CURRENT OF STANDARD PRODUCTS

D x L: mm

CAP. (μF)	RATED VOLTAGE WV (SURGE VOLTAGE WV)								
	2.5 SIZE			4 SIZE			6.3 SIZE		
	SIZE	RIPPLE	ESR	SIZE	RIPPLE	ESR	SIZE	RIPPLE	ESR
180									
270							6.3 x 10.5	3160	28.00
330							6.3 x 10.5	3190	28.00
390				6.3 x 10.5	3160	20.00	6.3 x 10.5	3190	28.00
470							8 x 11.5	5600	7.00
560	6.3 x 10.5	3160	20.00	6.3 x 10.5	3160	20.00			
680				8 x 11.5	5600	7.00			
820	6.3 x 10.5	3160	20.00				8 x 11.5	5600	7.00
							10 x 11.5	5050	7.00
1000	8 x 11.5	5600	7.00				10 x 11.5	5050	7.00
							10 x 12.5	5600	7.00
1200				8 x 11.5	5600	7.00	10 x 12.5	5600	7.00
				10 x 11.5	5050	7.00			
1500	8 x 11.5	5600	7.00	10 x 11.5	5050	7.00			
	10 x 11.5	5050	7.00	10 x 12.5	5600	7.00			
1800	10 x 12.5	5600	7.00	10 x 12.5	5600	7.00			
2700	10 x 12.5	5600	7.00						

Note: 1. Ripple Current: (mA/rms) 105°C, 100KHz

2. ESR: 100KHz / 20°C (mΩ)



**CASE SIZE & PERMISSIBLE RIPPLE CURRENT OF STANDARD PRODUCTS**

D x L: mm

CAP. (μF)	RATED VOLTAGE WV (SURGE VOLTAGE WV)								
	10 SIZE			16 SIZE			25 SIZE		
	SIZE	RIPPLE	ESR	SIZE	RIPPLE	ESR	SIZE	RIPPLE	ESR
33							8 x 11.5	2980	30.00
47							8 x 11.5	2980	30.00
56							8 x 11.5	2980	30.00
100				6.3 x 10.5	2820	25.00			
150				6.3 x 10.5	2820	25.00			
180	6.3 x 10.5	2820	25.00	8 x 11.5	4360	16.00			
220	6.3 x 10.5	2820	25.00	8 x 11.5	5000	11.00			
270				8 x 11.5	5000	11.00			
330	8 x 11.5	5600	7.00	8 x 11.5	5000	8.00			
				10 x 11.5	4000	10.00			
				10 x 12.5	6100	10.00			
390				10 x 12.5	5050	14.00			
470	8 x 11.5	5600	7.00	10 x 12.5	5050	14.00			
	10 x 11.5	4000	7.00						
560	10 x 12.5	5050	7.00	10 x 12.5	5050	14.00			
820	10 x 12.5	5050	7.00						

Note: 1. Ripple Current: (mA/rms) 105°C, 100KHz

2. ESR: 100KHz / 20°C (mΩ)

# Screw Type Aluminum Electrolytic Capacitors

## NP [ For General ]

For Large Power Source, Converter Circuit



### DESCRIPTION

Endurance : 85°C, 2000 Hours

It is suitable for high ripple current, large power source, converter circuit, etc.

### MULTIPLIER FOR RIPPLE CURRENT

Frequency Coefficient

FREQUENCY (Hz)	50	100 (120)	300	1K
10~50V	0.95	1.00	1.04	1.10
63~100V	0.95	1.00	1.06	1.16
160~200V	0.90	1.00	1.10	1.20
250~450V	0.80	1.00	1.10	1.20

FREQUENCY (Hz)	3K	5K	10K	20K
10~50V	1.12	1.13	1.15	1.15
63~100V	1.20	1.25	1.30	1.36
160~200V	1.35	1.40	1.50	1.55
250~450V	1.35	1.40	1.50	1.55

### ELECTRICAL CHARACTERISTICS

Operating Temperature Range	-40 to +85°C	-25 to +85°C
Rated Voltage Range	10 ~ 250V	315 ~ 450V
Rated Capacitance Range	1800 ~ 820000μF	
Capacitance Tolerance	±20% (120Hz, +20°C)	
Leakage Current	I = 0.02CV or 5mA whichever is smaller. (After 5 Minutes Application of DC Rated Voltage at 20°C)	
Dissipation Factor at 120Hz, +20°C	Less than the Value Specified in the Standard Product Tables	
Endurance	After the rated voltage has been applied at 85°C for 2000 hours, and then has resumed its original condition for 16 hours. (a) Capacitance Change: ±20% Initial Measured Value (b) Dissipation Factor: ≤ 2 Times Initial Specified Value (c) Leakage Current: ≤ Initial Specified Value	
Shelf Life	After having been stored for 1000 hours at 85°C, the rated voltage has been applied for 30 minutes, and then has resumed its original condition for 16 hours. (a) Capacitance Change: ±20% Initial Measured Value (b) Dissipation Factor: ≤ 2 Times Initial Specified Value (c) Leakage Current: ≤ Initial Specified Value	

### DIAGRAM OF DIMENSIONS

Unit: mm

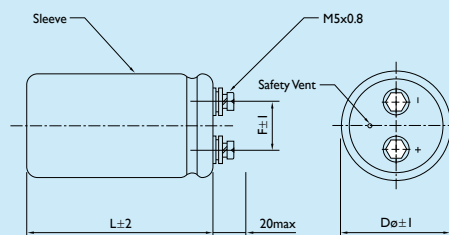

Dø	F
35	12.7
51	22
63.5	28.6
76	32
89	32

## CASE SIZE & PERMISSIBLE RIPPLE CURRENT OF STANDARD PRODUCTS

D x L: mm

CAP. (μF)	RATED VOLTAGE WV (SURGE VOLTAGE WV)											
	10 (13)			16 (20)			25 (32)			35 (44)		
	SIZE	RIPPLE CURRENT	DISSIPATION FACTOR	SIZE	RIPPLE CURRENT	DISSIPATION FACTOR	SIZE	RIPPLE CURRENT	DISSIPATION FACTOR	SIZE	RIPPLE CURRENT	DISSIPATION FACTOR
10000										35 x 50	3.40	0.40
12000										35 x 50	3.70	0.40
15000							35 x 50	3.70	0.50	35 x 65	4.20	0.40
18000							35 x 50	4.10	0.50	35 x 80	4.90	0.40
22000				35 x 50	4.10	0.60	35 x 50	4.50	0.50	35 x 80	5.70	0.40
27000				35 x 50	4.50	0.60	35 x 65	5.00	0.50	35 x 100	6.30	0.40
33000	35 x 50	4.30	0.80	35 x 50	5.00	0.60	35 x 80	5.90	0.50	35 x 100	7.20	0.40
39000	35 x 50	4.70	0.80	35 x 65	5.90	0.60	35 x 80	6.70	0.50	35 x 120	7.30	0.50
47000	35 x 65	5.20	0.80	35 x 80	6.40	0.60	35 x 100	7.70	0.50	35 x 120	8.70	0.50
56000	35 x 80	6.10	0.80	35 x 80	7.30	0.60	35 x 100	7.90	0.60	51 x 95	8.60	0.60
68000	35 x 80	6.70	0.80	35 x 100	8.40	0.60	35 x 120	9.10	0.60	51 x 95	9.80	0.60
82000	35 x 100	7.70	0.80	35 x 100	8.30	0.80	35 x 120	10.40	0.60	51 x 115	11.60	0.60
100000	35 x 100	8.80	0.80	35 x 120	9.50	0.80	51 x 95	10.30	0.80	63.5 x 95	13.30	0.60
120000	35 x 120	10.00	0.80	35 x 120	10.90	0.80	51 x 115	11.70	0.80	63.5 x 115	14.80	0.60
150000	35 x 120	10.80	1.00	51 x 95	11.30	1.00	51 x 130	14.10	0.80	63.5 x 120	14.90	0.80
180000	51 x 95	12.00	1.00	51 x 115	12.80	1.00	63.5 x 95	15.70	0.80	63.5 x 130	17.00	0.80
220000	51 x 120	11.20	1.50	51 x 130	15.30	1.00	63.5 x 115	16.10	1.00	76 x 115	20.00	0.80
270000	51 x 120	12.80	1.50	63.5 x 95	17.60	1.00	63.5 x 130	18.60	1.00	76 x 130	20.30	1.00
330000	63.5 x 95	15.30	1.50	63.5 x 115	16.80	1.50	63.5 x 155	21.90	1.00	76 x 155	23.50	1.00
390000	63.5 x 115	17.30	1.50	63.5 x 130	18.30	1.50	76 x 120	22.00	1.20	89 x 130	26.40	1.00
470000	63.5 x 130	16.70	2.00	76 x 120	21.30	1.50	76 x 155	25.60	1.20	89 x 155	29.60	1.00
560000	76 x 115	19.00	2.00	76 x 130	23.60	1.50	89 x 130	27.90	1.20			
680000	76 x 130	21.70	2.00	76 x 155	27.60	1.50	89 x 155	32.50	1.20			
820000	76 x 155	24.70	2.00	89 x 155	27.10	2.00						

Note: 1. Ripple Current: (A/rms) 85°C, 120Hz

2. Dissipation Factor: 120Hz / 20°C



## CASE SIZE & PERMISSIBLE RIPPLE CURRENT OF STANDARD PRODUCTS

D x L: mm

CAP. ( $\mu$ F)	RATED VOLTAGE WV (SURGE VOLTAGE WV)											
	50 (63)			63 (72)			80 (100)			100 (125)		
	SIZE	RIPPLE CURRENT	DISSIPATION FACTOR	SIZE	RIPPLE CURRENT	DISSIPATION FACTOR	SIZE	RIPPLE CURRENT	DISSIPATION FACTOR	SIZE	RIPPLE CURRENT	DISSIPATION FACTOR
1800										35 x 50	1.90	0.25
2200										35 x 50	2.10	0.25
2700										35 x 50	2.30	0.25
3300							35 x 50	2.50	0.25	35 x 65	2.60	0.25
3900				35 x 50	2.70	0.25	35 x 50	2.80	0.25	35 x 80	3.00	0.25
4700				35 x 50	3.00	0.25	35 x 65	3.00	0.25	35 x 80	3.50	0.25
5600	35 x 50	3.00	0.30	35 x 50	3.30	0.25	35 x 80	3.60	0.25	35 x 100	3.90	0.25
6800	35 x 50	3.30	0.30	35 x 65	3.60	0.25	35 x 80	3.90	0.25	35 x 100	4.50	0.25
8200	35 x 50	3.60	0.30	35 x 80	4.30	0.25	35 x 80	4.50	0.25	35 x 120	5.10	0.25
10000	35 x 65	4.00	0.30	35 x 80	4.90	0.25	35 x 100	5.20	0.25	35 x 120	5.90	0.25
12000	35 x 80	4.70	0.30	35 x 100	5.60	0.25	35 x 100	5.90	0.25	51 x 75	6.40	0.25
15000	35 x 80	5.50	0.30	35 x 100	5.90	0.30	35 x 120	6.80	0.25	51 x 95	7.00	0.25
18000	35 x 100	6.20	0.30	35 x 120	6.70	0.30	35 x 120	7.80	0.25	51 x 115	8.30	0.25
22000	35 x 120	6.30	0.40	35 x 120	7.80	0.30	51 x 95	8.00	0.30	51 x 130	10.00	0.25
27000	35 x 120	7.10	0.40	51 x 95	7.40	0.40	51 x 95	9.20	0.30	63.5 x 115	11.50	0.25
33000	51 x 95	8.20	0.40	51 x 95	8.40	0.40	51 x 115	10.50	0.30	63.5 x 130	11.90	0.25
39000	51 x 95	8.10	0.50	51 x 115	9.50	0.40	51 x 130	12.00	0.30	76 x 115	13.40	0.25
47000	51 x 115	9.30	0.50	51 x 130	11.30	0.40	63.5 x 115	13.60	0.30	76 x 130	14.20	0.35
56000	63.5 x 95	10.50	0.50	63.5 x 115	12.80	0.40	63.5 x 130	13.40	0.40	76 x 155	16.00	0.35
68000	63.5 x 95	12.00	0.50	63.5 x 120	12.70	0.50	76 x 115	15.40	0.40	89 x 130	18.80	0.35
82000	63.5 x 115	13.70	0.50	63.5 x 130	14.50	0.50	76 x 130	17.50	0.40	89 x 155	20.50	0.35
100000	76 x 115	14.70	0.60	76 x 115	16.70	0.50	76 x 155	20.50	0.40	89 x 171	24.00	0.35
120000	76 x 120	16.70	0.60	76 x 130	18.90	0.50	89 x 130	22.70	0.40			
150000	76 x 130	19.30	0.60	76 x 155	22.40	0.50	89 x 155	26.50	0.40			
180000	76 x 155	21.90	0.60	89 x 130	22.40	0.60						
220000	89 x 130	21.40	0.60	89 x 155	26.20	0.60						
270000	89 x 155	24.60	0.60									

Note: 1. Ripple Current: (A/rms) 85°C, 120Hz

2. Dissipation Factor: 120Hz / 20°C

## CASE SIZE & PERMISSIBLE RIPPLE CURRENT OF STANDARD PRODUCTS

D x L: mm

CAP. ( $\mu$ F)	RATED VOLTAGE WV (SURGE VOLTAGE WV)											
	160 (200)			200 (250)			250 (300)			350 (400)		
	SIZE	RIPPLE CURRENT	DISSIPATION FACTOR	SIZE	RIPPLE CURRENT	DISSIPATION FACTOR	SIZE	RIPPLE CURRENT	DISSIPATION FACTOR	SIZE	RIPPLE CURRENT	DISSIPATION FACTOR
390										35 x 50	1.67	0.20
470										35 x 80	2.15	0.20
560										35 x 80	2.37	0.20
680										35 x 80	2.59	0.20
820										35 x 100	3.07	0.20
1000										35 x 100	3.41	0.20
1200										51 x 75	3.81	0.20
1500							35 x 100	3.22	0.25	51 x 75	4.26	0.20
1800							35 x 100	3.52	0.25	51 x 95	5.14	0.20
2200				35 x 100	3.92	0.25	51 x 75	4.00	0.25	51 x 95	5.70	0.20
2700				35 x 120	4.70	0.25	51 x 75	4.44	0.25	51 x 130	7.14	0.20
3300	35 x 120	5.18	0.25	51 x 75	4.92	0.25	51 x 95	5.40	0.25	51 x 130	7.92	0.20
3900	51 x 75	5.33	0.25	51 x 75	5.33	0.25	51 x 115	6.29	0.25	63.5 x 115	9.00	0.20
4700	51 x 75	5.85	0.25	51 x 95	6.44	0.25	63.5 x 95	7.10	0.25	63.5 x 130	10.33	0.20
5600	51 x 95	7.03	0.25	51 x 115	7.55	0.25	63.5 x 95	7.77	0.25	76 x 115	11.36	0.20
6800	51 x 95	7.77	0.25	51 x 130	8.77	0.25	63.5 x 115	9.14	0.25	76 x 130	13.10	0.20
8200	51 x 115	9.14	0.25	63.5 x 95	9.40	0.25	63.5 x 115	10.03	0.25	76 x 155	15.43	0.20
10000	63.5 x 95	10.36	0.25	63.5 x 95	10.36	0.25	63.5 x 130	11.66	0.25	89 x 155	18.13	0.20
12000	63.5 x 95	11.32	0.25	76 x 95	12.06	0.25	76 x 115	12.88	0.25	89 x 155	20.02	0.20
15000	63.5 x 130	14.28	0.25	76 x 95	14.43	0.25	76 x 130	15.10	0.25	89 x 195	24.50	0.20
18000	63.5 x 130	15.61	0.25	76 x 130	16.50	0.25	76 x 155	17.69	0.25	89 x 235	28.83	0.20
22000	76 x 130	18.28	0.25	76 x 155	19.61	0.25	89 x 155	20.91	0.25			
27000	76 x 130	20.24	0.25	89 x 130	21.51	0.25						
30000	89 x 130	23.75	0.25	89 x 155	25.53	0.25						
39000	89 x 155	27.86	0.25									

Note: 1. Ripple Current: (A/rms) 85°C, 120Hz.

2. Dissipation Factor: 120Hz / 20°C



## CASE SIZE & PERMISSIBLE RIPPLE CURRENT OF STANDARD PRODUCTS

D x L: mm

CAP. (μF)	RATED VOLTAGE WV (SURGE VOLTAGE WV)					
	400 (450) SIZE	RIPPLE CURRENT	DISSIPATION FACTOR	450 (500) SIZE	RIPPLE CURRENT	DISSIPATION FACTOR
270				35 x 50	1.37	0.20
330	35 x 50	1.52	0.20	35 x 80	1.82	0.20
390	35 x 80	1.96	0.20	35 x 80	1.96	0.20
470	35 x 80	2.15	0.20	35 x 80	2.15	0.20
560	35 x 80	2.37	0.20	35 x 100	2.55	0.20
680	35 x 100	1.82	0.20	35 x 100	2.81	0.20
820	35 x 100	3.07	0.20	51 x 75	3.18	0.20
1000	51 x 75	3.48	0.20	51 x 75	3.48	0.20
1200	51 x 75	3.82	0.20	51 x 95	4.22	0.20
1500	51 x 95	4.70	0.20	51 x 115	5.07	0.20
1800	51 x 95	5.15	0.20	51 x 130	5.85	0.20
2200	51 x 130	6.44	0.20	63.5 x 95	6.29	0.20
2700	51 x 130	6.96	0.20	63.5 x 115	7.48	0.20
3300	63.5 x 95	8.22	0.20	63.5 x 130	8.66	0.20
3900	63.5 x 115	9.40	0.20	76 x 115	9.47	0.20
4700	63.5 x 130	10.44	0.20	76 x 130	10.88	0.20
5600	76 x 115	11.92	0.20	76 x 155	12.80	0.20
6800	76 x 155	14.06	0.20	89 x 155	15.00	0.20
8200	89 x 155	16.43	0.20	89 x 155	16.50	0.20
10000	89 x 155	18.28	0.20	89 x 195	20.00	0.20
12000	89 x 195	21.84	0.20	89 x 235	23.61	0.20
15000	89 x 235	26.31	0.20			

Note: 1. Ripple Current: (A/rms) 85°C, 120Hz.

2. Dissipation Factor: 120Hz / 20°C

# NM [ For Wide Temperature ]

Applicable for Large Power Source, Converter Circuit

## Screw Type Aluminum Electrolytic Capacitors

### ELECTRICAL CHARACTERISTICS

Operating Temperature Range	-40 to +105°C	-25 to +105°C
Rated Voltage Range	25 ~ 100V	160 ~ 450V
Rated Capacitance Range	220 ~ 330000 $\mu$ F	
Capacitance Tolerance	$\pm$ 20% (120Hz, +20°C)	
Leakage Current	I = 0.02CV or 5mA whichever is smaller. (After 5 Minutes Application of DC Rated Voltage at 20°C)	
Dissipation Factor at 120Hz, +20°C	Less than the Value Specified in the Standard Product Tables	
Endurance	After the rated voltage has been applied at 105°C for 2000 hours and then has resumed its original condition for 16 hours. (a) Capacitance Change: $\pm$ 20% Initial Measured Value (b) Dissipation Factor: $\leq$ 2 Times Initial Specified Value (c) Leakage Current: $\leq$ Initial Specified Value	
Shelf Life	After having been stored for 1000 hours at 105°C, the rated voltage has been applied for 30 minutes and then has resumed its original condition for 16 hours. (a) Capacitance Change: $\pm$ 20% Initial Measured Value (b) Dissipation Factor: $\leq$ 2 Times Initial Specified Value (c) Leakage Current: $\leq$ Initial Specified Value	

### DIAGRAM OF DIMENSIONS

Unit: mm

D $\phi$	F
35	12.7
51	22
63.5	28.6
76	32
89	32

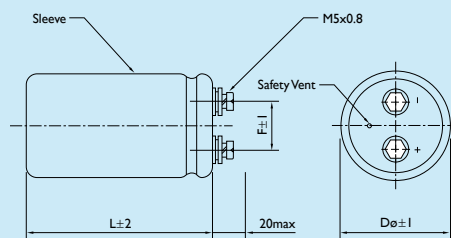

### DESCRIPTION

Endurance : 105°C 2000 Hours

High Ripple Current, Load Life of 2000 hours at 105°C

### MULTIPLIER FOR RIPPLE CURRENT

Frequency Coefficient

FREQUENCY (Hz)	50	60	100 (120)
FACTOR	0.80	0.80	1.00
FREQUENCY (Hz)	300	1K	$\geq$ 10K
FACTOR	1.10	1.30	1.40



## CASE SIZE & PERMISSIBLE RIPPLE CURRENT OF STANDARD PRODUCTS

D × L: mm

CAP. (μF)	RATED VOLTAGE WV (SURGE VOLTAGE WV)								
	25 (32)			35 (44)			50 (63)		
	SIZE	RIPPLE CURRENT	DISSIPATION FACTOR	SIZE	RIPPLE CURRENT	DISSIPATION FACTOR	SIZE	RIPPLE CURRENT	DISSIPATION FACTOR
3300							35 × 50	2.20	0.2
4700							35 × 50	3.30	0.25
6800				35 × 50	2.60	0.30	35 × 80	3.40	0.25
10000	35 × 50	2.90	0.35	35 × 80	3.70	0.30	35 × 80	4.10	0.25
15000	35 × 80	4.20	0.35	35 × 80	4.50	0.30	35 × 100	4.90	0.30
22000	35 × 80	5.10	0.35	35 × 100	5.50	0.35	51 × 75	5.90	0.35
33000	35 × 100	6.30	0.40	51 × 75	6.70	0.40	51 × 115	7.80	0.40
47000	51 × 75	8.00	0.40	51 × 95	8.10	0.45	63.5 × 95	9.50	0.40
68000	51 × 115	10.00	0.50	51 × 115	10.00	0.50	63.5 × 115	11.60	0.45
100000	63.5 × 95	11.30	0.60	63.5 × 115	12.10	0.60	76 × 115	14.10	0.50
150000	63.5 × 115	12.90	0.80	76 × 115	13.80	0.70	89 × 130	18.90	0.50
220000	76 × 115	14.80	1.00	89 × 130	17.60	0.70			
330000	89 × 130	19.90	1.00						

Note: 1. Ripple Current: (A/rms) 105°C, 120Hz

2. Dissipation Factor: 120Hz / 20°C



**CASE SIZE & PERMISSIBLE RIPPLE CURRENT OF STANDARD PRODUCTS**

D x L: mm

CAP. (μF)	RATED VOLTAGE WV (SURGE VOLTAGE WV)								
	63 (79)			80 (100)			100 (125)		
	SIZE	RIPPLE CURRENT	DISSIPATION FACTOR	SIZE	RIPPLE CURRENT	DISSIPATION FACTOR	SIZE	RIPPLE CURRENT	DISSIPATION FACTOR
1000							35 x 50	1.40	0.15
1500							35 x 50	1.70	0.15
2200	35 x 50	2.10	0.15	35 x 50	2.10	0.15	35 x 80	2.50	0.15
3300	35 x 50	2.20	0.20	35 x 80	3.00	0.15	35 x 80	3.00	0.15
4700	35 x 80	3.10	0.20	35 x 80	3.60	0.15	35 x 100	3.90	0.15
6800	35 x 80	3.70	0.20	35 x 100	4.00	0.20	51 x 75	5.00	0.15
10000	35 x 100	4.40	0.25	51 x 75	5.20	0.20	51 x 95	6.50	0.15
15000	51 x 75	5.70	0.25	51 x 95	6.20	0.25	63.5 x 95	7.60	0.20
22000	51 x 95	6.80	0.30	63.5 x 95	8.20	0.25	76 x 95	9.70	0.20
33000	63.5 x 95	9.20	0.30	76 x 95	9.70	0.30	76 x 130	11.80	0.25
47000	63.5 x 115	10.90	0.35	76 x 115	12.50	0.30	89 x 130	15.00	0.25
68000	76 x 115	13.00	0.40	89 x 130	16.40	0.30			
100000	89 x 130	17.20	0.40						

Note: 1. Ripple Current: (A/rms) 105°C, 120Hz

2. Dissipation Factor: 120Hz / 20°C



## CASE SIZE & PERMISSIBLE RIPPLE CURRENT OF STANDARD PRODUCTS

D × L: mm

CAP. (μF)	RATED VOLTAGE WV (SURGE VOLTAGE WV)								
	160 (200)			200 (250)			250 (300)		
	SIZE	RIPPLE CURRENT	DISSIPATION FACTOR	SIZE	RIPPLE CURRENT	DISSIPATION FACTOR	SIZE	RIPPLE CURRENT	DISSIPATION FACTOR
330				35 × 50	0.80	0.15	35 × 50	0.80	0.15
470	35 × 50	1.00	0.15	35 × 50	1.00	0.15	35 × 50	1.00	0.15
680	35 × 50	1.10	0.15	35 × 50	1.10	0.15	35 × 80	1.40	0.15
1000	35 × 80	1.70	0.15	35 × 80	1.70	0.15	35 × 100	1.90	0.15
1500	35 × 80	2.00	0.15	35 × 100	2.20	0.15	51 × 75	2.30	0.15
2200	35 × 100	2.70	0.15	51 × 75	2.80	0.15	51 × 95	3.10	0.15
3300	51 × 80	3.50	0.15	51 × 95	3.70	0.15	63.5 × 95	4.20	0.15
4700	51 × 95	4.40	0.15	63.5 × 95	4.90	0.15	63.5 × 115	5.40	0.15
6800	63.5 × 95	5.90	0.15	63.5 × 115	6.30	0.15	76 × 115	6.90	0.15
10000	76 × 95	7.60	0.15	76 × 115	8.10	0.15	76 × 155	9.30	0.15
15000	76 × 130	10.30	0.15	89 × 130	10.90	0.15	89 × 155	12.20	0.15
22000	89 × 130	13.20	0.15						

Note: 1. Ripple Current: (A/rms) 105°C, 120Hz

2. Dissipation Factor: 120Hz / 20°C

**CASE SIZE & PERMISSIBLE RIPPLE CURRENT OF STANDARD PRODUCTS**

D x L: mm

CAP. (μF)	RATED VOLTAGE WV (SURGE VOLTAGE WV)					
	400 (450) SIZE			450 (500) SIZE		
		RIPPLE CURRENT	DISSIPATION FACTOR		RIPPLE CURRENT	DISSIPATION CURRENT
220				35 x 50	1.10	0.15
330				35 x 100	1.50	0.15
470				51 x 80	2.10	0.15
680				51 x 95	2.70	0.15
1000	51 x 75	2.50	0.15	51 x 100	4.20	0.15
1200	51 x 95	3.00	0.15			
1500	51 x 115	3.60	0.15	51 x 130	5.70	0.15
1800	51 x 130	4.10	0.15			
2200	63.5 x 95	4.50	0.15	63.5 x 115	7.30	0.15
2700	63.5 x 115	5.30	0.15			
3300	63.5 x 130	6.20	0.15	76 x 130	10.10	0.15
3900	63.5 x 155	7.20	0.15			
	76 x 115	6.80	0.15			
4700	63.5 x 195	8.70	0.15	76 x 155	12.60	0.15
	76 x 130	7.80	0.15			
5600	63.5 x 195	9.60	0.15	89 x 155	15.80	0.15
	76 x 155	9.20	0.15			
6800	89 x 155	10.70	0.15			
8200	89 x 155	11.80	0.15			
10000	89 x 195	14.10	0.15			

Note: 1. Ripple Current: (A/rms) 105°C, 120Hz

2. Dissipation Factor: 120Hz / 20°C

# Screw Type Aluminum Electrolytic Capacitors

# NF [ Long Life for Inverter ]

Specially For Higher Voltage with Compact Size



## DESCRIPTION

Endurance : 85°C, 5000 Hours

Higher voltage with compact size, to be used in inverters.

### MULTIPLIER FOR RIPPLE CURRENT

Frequency Coefficient

FREQUENCY (Hz)	50	60	100(120)	300	1K	≥10K
FACTOR	0.70	0.70	1.00	1.10	1.30	1.40

## ELECTRICAL CHARACTERISTICS

Operating Temperature Range	-40 to +85°C		
Rated Voltage Range	400V, 450V		
Rated Capacitance Range	1800 ~ 22000μF		
Capacitance Tolerance	±20% (120Hz, +20°C)		
Leakage Current	I = 0.01CV or 5mA Whichever is smaller. (After 5 Minutes Application of DC Voltage at 20°C)		
Dissipation Factor at 120Hz, +20°C	Rate Voltage (V)	400	450
	tan δ	0.15	0.15
Endurance	After the rated voltage has been applied at 85°C for 5000 hours, and then has resumed its original condition for 16 hours. (a) Capacitance Change: ±15% Initial Measured Value (b) Dissipation Factor: ≤ 1.75 Times Initial Specified Value (c) Leakage Current: ≤ Initial Specified Value		
Shelf Life	After having been stored for 1000 hours at 85°C, the rated voltage has been applied for 30 minutes, and then has resumed its original condition for 16 hours. (a) Capacitance Change: ±15% Initial Measured Value (b) Dissipation Factor: ≤ 1.75 Times Initial Specified Value (c) Leakage Current: ≤ Initial Specified Value		

## DIAGRAM OF DIMENSIONS

Unit: mm

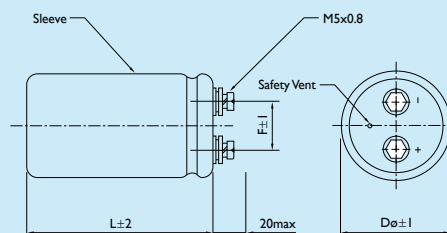

Dø	F
51	22
63.5	28.6
76	32
89	32
101	41.5

**CASE SIZE & PERMISSIBLE RIPPLE CURRENT OF STANDARD PRODUCTS**

D x L: mm

CAP. (μF)	RATED VOLTAGE WV (SURGE VOLTAGE WV)					
	400 (450) SIZE			450 (500) SIZE		
		RIPPLE CURRENT	DISSIPATION FACTOR		RIPPLE CURRENT	DISSIPATION FACTOR
1800				51 x 115	7.60	0.15
2200	51 x 115	8.80	0.15	51 x 130	8.80	0.15
2700	51 x 130	10.20	0.15	63.5 x 95	9.50	0.15
3300	63.5 x 95	11.00	0.15	63.5 x 115	11.20	0.15
3900	63.5 x 115	12.80	0.15	63.5 x 130	12.80	0.15
4700	63.5 x 130	14.80	0.15	76 x 115	14.10	0.15
5600	76 x 115	16.20	0.15	76 x 130	16.20	0.15
6800	76 x 130	18.70	0.15	76 x 155	19.10	0.15
8200	76 x 155	22.00	0.15	76 x 195	23.00	0.15
				89 x 130	21.00	0.15
10000	76 x 195	26.70	0.15	89 x 170	25.70	0.15
	89 x 130	24.20	0.15			
12000	89 x 155	28.50	0.15	89 x 195	29.70	0.15
				101 x 175	29.30	0.15
15000	89 x 195	34.80	0.15	89 x 235	35.90	0.15
				101 x 195	34.20	0.15
18000	89 x 235	41.20	0.15	101 x 235	40.20	0.15
22000	101 x 235	47.00	0.15			

Note: 1. Ripple Current: (A/rms) 85°C, 120Hz

2. Dissipation Factor: 120Hz / 20°C

# Screw Type Aluminum Electrolytic Capacitors

# NH [ High Temperature, Long Life for Inverter ]

High Ripple Current Products



## DESCRIPTION

Endurance : 105°C 5000 Hours

### MULTIPLIER FOR RIPPLE CURRENT

Frequency Coefficient

FREQUENCY (Hz)	50	120	1K	10K	50K
10~50V	0.95	1.00	1.05	1.09	1.12
63~100V	0.90	1.00	1.10	1.18	1.22
100~250V	0.80	1.00	1.22	1.30	1.33
350~500V	0.80	1.00	1.50	1.60	1.70

## ELECTRICAL CHARACTERISTICS

Operating Temperature Range	-40 to +105°C	-25 to +105°C
Rated Voltage Range	10 ~ 100V	160 ~ 500V
Rated Capacitance Range	330 ~ 390000μF	
Capacitance Tolerance	±20% (120Hz, +20°C)	
Leakage Current	I = 0.02CV or 5mA whichever is smaller. (After 5 Minutes Application of DC Voltage at 20°C)	
Temperature Characteristics	Impedance Ratio at 120Hz	
	Ur (V)	10~100      160~500
	Z -25°C / Z +20°C	-                  8
	Z -40°C / Z +20°C	12                -
Endurance	After the rated voltage has been applied at 105°C for 5000 hours and then has resumed its original condition for 16 hours. (a) Capacitance Change: ±20% Initial Measured Value (b) Dissipation Factor: ≤ 2 Times Initial Specified Value (c) Leakage Current: ≤ Initial Specified Value	
Shelf Life	After having been stored for 1000 hours at 105°C, the rated voltage has been applied for 30 minutes and then has resumed its original condition for 16 hours. (a) Capacitance Change: ±20% Initial Measured Value (b) Dissipation Factor: ≤ 2 Times Initial Specified Value (c) Leakage Current: ≤ Initial Specified Value	

## DIAGRAM OF DIMENSIONS

Unit: mm

Dø	W	l	α	NOMINAL DIA. OF BOLT
51	22	6	3	M5
63.5	28.6	6	3	M5
76	31.8	6	3	M5
89	31.8	6	3	M5

## CASE SIZE & PERMISSIBLE RIPPLE CURRENT OF STANDARD PRODUCTS

D x L: mm

CAP. ( $\mu$ F)	RATED VOLTAGE WV (SURGE VOLTAGE WV)											
	10 (13)			16 (20)			25 (32)			35 (44)		
	SIZE	RIPPLE CURRENT	DISSIPATION FACTOR	SIZE	RIPPLE CURRENT	DISSIPATION FACTOR	SIZE	RIPPLE CURRENT	DISSIPATION FACTOR	SIZE	RIPPLE CURRENT	DISSIPATION FACTOR
8200										35 x 80	3.0	0.30
10000										35 x 80	3.3	0.30
12000							35 x 80	3.3	0.35	35 x 80	3.6	0.30
15000				35 x 50	2.9	0.45	35 x 80	3.7	0.35	35 x 80	4.1	0.30
18000				35 x 80	3.5	0.45	35 x 80	4.0	0.35	35 x 100	4.8	0.30
22000				35 x 80	3.9	0.45	35 x 80	4.5	0.35	35 x 120	5.2	0.35
27000	35 x 80	4.3	0.45	35 x 80	4.3	0.45	35 x 100	5.0	0.40	51 x 80	5.9	0.40
33000	35 x 80	4.7	0.45	35 x 100	4.8	0.50	35 x 120	5.9	0.40	51 x 100	6.6	0.40
39000	35 x 80	5.3	0.45	35 x 100	5.3	0.50	51 x 80	6.5	0.40	51 x 120	7.8	0.40
47000	35 x 100	6.1	0.45	35 x 120	6.2	0.50	51 x 100	7.9	0.40	51 x 120	8.0	0.45
56000	35 x 100	6.2	0.50	51 x 80	6.3	0.60	51 x 120	8.8	0.40	63.5 x 100	9.2	0.45
68000	35 x 120	6.8	0.60	51 x 100	7.6	0.60	51 x 120	9.1	0.50	63.5 x 120	11.0	0.45
82000	51 x 80	7.8	0.60	51 x 120	8.3	0.70	63.5 x 100	10.6	0.50	76 x 120	12.7	0.50
100000	51 x 100	8.5	0.70	51 x 120	9.2	0.70	63.5 x 120	11.4	0.60	76 x 140	13.5	0.60
120000	51 x 100	9.5	0.70	63.5 x 100	9.9	0.80	76 x 100	12.8	0.60	89 x 140	16.1	0.60
150000	63.5 x 100	11.0	0.80	76 x 100	12.3	0.80	76 x 120	13.7	0.75			
180000	63.5 x 100	12.1	0.80	76 x 120	14.5	0.80	76 x 140	16.1	0.76			
220000	76 x 100	13.2	1.00	76 x 140	15.2	1.00	89 x 140	16.6	1.00			
270000	76 x 120	14.4	1.20	89 x 140	16.8	1.20						
330000	76 x 140	17.0	1.20									
390000	89 x 140	18.6	1.40									

Note: 1. Max. Allowable Ripple Current: (A/rms) 105°C, 120Hz

2. Dissipation Factor: 120Hz / 20°C



## CASE SIZE & PERMISSIBLE RIPPLE CURRENT OF STANDARD PRODUCTS

D × L: mm

CAP. (μF)	RATED VOLTAGE WV (SURGE VOLTAGE WV)											
	50 (63)			63 (79)			80 (100)			100 (125)		
	SIZE	RIPPLE CURRENT	DISSIPATION FACTOR	SIZE	RIPPLE CURRENT	DISSIPATION FACTOR	SIZE	RIPPLE CURRENT	DISSIPATION FACTOR	SIZE	RIPPLE CURRENT	DISSIPATION FACTOR
1200										35 × 50	1.4	0.15
1500										35 × 80	1.6	0.15
1800										35 × 80	1.8	0.15
2200							35 × 50	1.9	0.15	35 × 80	2.0	0.15
2700				35 × 50	1.9	0.19	35 × 80	2.2	0.15	35 × 80	2.4	0.15
3300				35 × 50	2.1	0.15	35 × 80	2.5	0.15	35 × 100	2.8	0.15
3900	35 × 50	2.0	0.20	35 × 80	2.7	0.20	35 × 80	2.9	0.15	35 × 120	3.1	0.15
4700	35 × 50	2.2	0.25	35 × 80	2.9	0.20	35 × 100	3.1	0.15	51 × 80	3.6	0.15
5600	35 × 80	2.8	0.25	35 × 80	3.2	0.20	35 × 100	3.6	0.15	51 × 100	4.3	0.15
6800	35 × 80	3.0	0.25	35 × 80	3.5	0.20	35 × 120	4.1	0.20	51 × 120	5.0	0.15
8200	35 × 80	3.3	0.25	35 × 100	4.2	0.25	51 × 80	4.8	0.20	51 × 120	5.5	0.15
10000	35 × 80	3.7	0.25	35 × 120	4.3	0.25	51 × 100	5.6	0.20	63.5 × 100	6.4	0.15
12000	35 × 100	4.4	0.25	51 × 80	4.8	0.25	51 × 100	6.1	0.20	63.5 × 120	6.6	0.20
15000	35 × 120	4.7	0.30	51 × 100	5.9	0.25	51 × 120	7.4	0.20	76 × 100	7.5	0.20
18000	51 × 80	4.8	0.35	51 × 120	6.3	0.30	63.5 × 120	8.0	0.25	76 × 120	8.0	0.25
22000	51 × 100	5.9	0.35	51 × 120	6.7	0.30	76 × 100	9.1	0.25	76 × 140	9.4	0.25
27000	51 × 120	7.0	0.35	63.5 × 120	8.8	0.30	76 × 120	9.7	0.30	89 × 140	10.4	0.30
33000	63.5 × 100	7.6	0.40	76 × 120	10.0	0.35	76 × 140	11.5	0.30			
39000	63.5 × 120	8.9	0.40	76 × 140	12.5	0.35	89 × 140	12.5	0.30			
47000	63.5 × 120	9.8	0.40	89 × 140	13.8	0.40						
56000	76 × 120	11.9	0.40									
68000	76 × 140	13.1	0.45									
82000	89 × 140	14.8	0.50									

Note: 1. Max. Allowable Ripple Current: (A/rms) 105°C, 120Hz

2. Dissipation Factor: 120Hz / 20°C



## CASE SIZE & PERMISSIBLE RIPPLE CURRENT OF STANDARD PRODUCTS

D x L: mm

CAP. ( $\mu$ F)	RATED VOLTAGE WV (SURGE VOLTAGE WV)											
	160 (200)			200 (250)			250 (300)			350 (400)		
	SIZE	RIPPLE CURRENT	DISSIPATION FACTOR	SIZE	RIPPLE CURRENT	DISSIPATION FACTOR	SIZE	RIPPLE CURRENT	DISSIPATION FACTOR	SIZE	RIPPLE CURRENT	DISSIPATION FACTOR
330							35 x 50	0.7	0.15			
390							35 x 80	0.8	0.15			
470				35 x 50	0.9	0.15	35 x 80	0.9	0.15			
560				35 x 80	1.0	0.15	35 x 80	1.0	0.15			
680	35 x 50	1.1	0.15	35 x 80	1.1	0.15	35 x 100	1.2	0.15			
820	35 x 80	1.2	0.15	35 x 80	1.3	0.15	35 x 100	1.4	0.15	51 x 81	3.3	0.25
1000	35 x 80	1.3	0.15	35 x 80	1.5	0.15	35 x 120	1.6	0.15			
1200	35 x 80	1.5	0.15	35 x 100	1.7	0.15	51 x 80	1.8	0.15			
1500	35 x 80	1.7	0.15	35 x 120	1.9	0.15	51 x 100	2.2	0.15	51 x 90	5.2	0.25
1800	35 x 100	2.0	0.15	35 x 120	2.2	0.15	51 x 120	2.6	0.15			
2200	35 x 120	2.3	0.15	51 x 80	2.7	0.15	51 x 120	2.8	0.15	51 x 100	7.0	0.25
2700	35 x 120	2.7	0.15	51 x 100	3.2	0.15	63.5 x 100	3.3	0.15	51 x 130	8.4	0.25
										63.5 x 90	8.1	0.25
3300	51 x 100	3.3	0.15	51 x 120	3.5	0.15	63.5 x 120	4.0	0.15	51 x 150	9.9	0.25
3900	51 x 120	3.8	0.15	63.5 x 100	4.0	0.15	76 x 100	4.4	0.15	63.5 x 130	11.5	0.25
										76 x 90	10.8	0.25
4700	51 x 120	4.2	0.15	63.5 x 120	4.7	0.15	76 x 120	5.2	0.15			
5600	51 x 120	4.7	0.15	76 x 100	5.3	0.15	76 x 140	6.1	0.15	63.5 x 150	14.7	0.25
6800	63.5 x 120	5.7	0.15	76 x 120	6.3	0.15	89 x 140	7.4	0.15	76 x 130	16.8	0.25
8200	76 x 100	6.4	0.20	76 x 140	6.4	0.20				76 x 150	19.6	0.25
10000	76 x 120	6.8	0.20	89 x 140	7.7	0.20				76 x 190	23.0	0.25
12000	76 x 140	7.8	0.20									
15000	89 x 140	9.5	0.20							89 x 190	30.6	0.25
22000										89 x 270	43.5	0.25

Note: 1. Max. Allowable Ripple Current: (A/rms) 105°C, 120Hz

2. Dissipation Factor: 120Hz / 20°C



## CASE SIZE & PERMISSIBLE RIPPLE CURRENT OF STANDARD PRODUCTS

D x L: mm

CAP. ( $\mu$ F)	RATED VOLTAGE WV (SURGE VOLTAGE WV)								
	400 (450) SIZE			450 (500) SIZE			500 (550) SIZE		
	SIZE	RIPPLE CURRENT	DISSIPATION FACTOR	SIZE	RIPPLE CURRENT	DISSIPATION FACTOR	SIZE	RIPPLE CURRENT	DISSIPATION FACTOR
470							51 x 80	2.4	0.20
560				51 x 80	2.6	0.25			
680	51 x 80	3.0	0.25						
820							51 x 90	3.6	0.20
1000				51 x 90	4.0	0.25	51 x 110	4.4	0.20
1200	51 x 90	4.7	0.25	51 x 110	4.8	0.25	51 x 130	5.2	0.20
							63.5 x 90	5.0	0.20
1500							51 x 150	6.3	0.20
1800	51 x 110	6.3	0.25	51 x 130	6.4	0.25	63.5 x 110	6.8	0.20
				63.5 x 90	6.2	0.25			
2200	51 x 130	7.5	0.25	51 x 150	7.6	0.25			
	63.5 x 90	7.3	0.25	63.5 x 100	7.5	0.25			
2700	51 x 150	8.9	0.25	63.5 x 130	8.9	0.25	63.5 x 150	9.6	0.20
	63.5 x 110	8.8	0.25	76 x 90	8.4	0.25	76 x 110	9.2	0.20
3300	63.5 x 130	10.5	0.25	63.5 x 150	10.6	0.25			
	76 x 90	9.9	0.25	76 x 110	10.2	0.25			
3900				76 x 130	11.9	0.25	76 x 150	12.7	0.20
							89 x 130	11.9	0.20
4700	63.5 x 150	13.4	0.25	76 x 150	14.0	0.25			
	76 x 130	13.9	0.25						
5600				89 x 130	14.2	0.25			
6800	76 x 150	17.9	0.25	76 x 190	17.3	0.25	89 x 190	18.8	0.20
	89 x 130	17.2	0.25	89 x 150	16.7	0.25			
8200	76 x 190	20.8	0.25						
	89 x 150	20.1	0.25						
10000				89 x 190	22.8	0.25	89 x 270	26.8	0.20
12000	89 x 190	27.4	0.25						
15000				89 x 270	32.8	0.25			
22000	89 x 270	39.4	0.25						

Note: 1. Max. Allowable Ripple Current: (A/rms) 105°C, 120Hz

2. Dissipation Factor: 120Hz / 20°C

# Screw Type Aluminum Electrolytic Capacitors

# NG [ For Low Voltage, Large Capacity ]

Low Leakage Current, Small Size and High Ripple Current

## ELECTRICAL CHARACTERISTICS

Operating Temperature Range	-40 to +85°C
Rated Voltage Range	10 ~ 100V
Rated Capacitance Range	2200 ~ 1000000μF
Capacitance Tolerance	±20% (120Hz, 20°C)
Leakage Current	D = 35mm I ≤ 0.02CV (μA) or 4mA (at 20°C, after 2 minutes, whichever is smaller.) D ≥ 51mm I ≤ 0.03CV (μA) or 6mA (at 20°C, after 2 minutes, whichever is smaller.)
Endurance	After the rated voltage has been applied at 85°C for 2000 hours and then has resumed its original condition for 16 hours. (a) Capacitance Change: ±15% Initial Measured Value (b) Dissipation Factor: ≤ 2 Times Initial Specified Value (c) Leakage Current: ≤ Initial Specified Value
Shelf Life	After having been stored for 1000 hours at 85°C and then has resumed its original condition for 16 hours. (a) Capacitance Change: ±15% Initial Measured Value (b) Dissipation Factor: ≤ 2 Times Initial Specified Value (c) Leakage Current: ≤ Initial Specified Value



## DESCRIPTION

Endurance : 85°C 2000 Hours  
Low Voltage (≤ 100V), Large Capacitance, Lug or Screw Type, Low Dissipation Factor

## DIAGRAM OF DIMENSIONS

Unit: mm

Dø	F	L
35	12	50, 60, 80, 100, 120
51	22	80, 100, 120
63.5	28	100, 120, 140
76	32	100, 120, 140
89	32	140

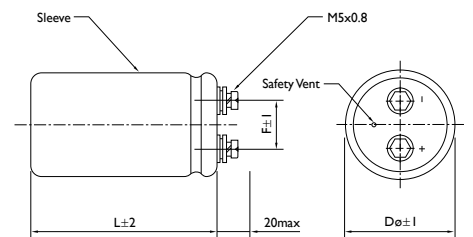
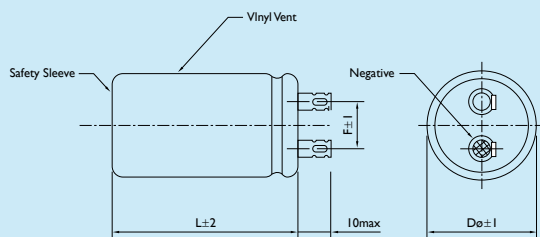



## CASE SIZE & PERMISSIBLE RIPPLE CURRENT OF STANDARD PRODUCTS

D x L: mm

CAP. (μF)	RATED VOLTAGE WV (SURGE VOLTAGE WV)								
	6.3 (8)			10 (13)			16 (20)		
	SIZE	RIPPLE CURRENT	DISSIPATION FACTOR	SIZE	RIPPLE CURRENT	DISSIPATION FACTOR	SIZE	RIPPLE CURRENT	DISSIPATION FACTOR
22000							35 x 50	4.50	0.50
33000				35 x 50	4.20	0.75	35 x 80	6.40	0.50
47000				35 x 80	6.20	0.75	35 x 100	8.20	0.50
68000				35 x 100	8.00	0.75	35 x 120	10.50	0.50
100000				35 x 120	10.40	0.75	51 x 80	10.70	0.75
150000				51 x 80	11.30	1.00	51 x 120	14.80	0.75
220000				51 x 120	15.50	1.00	63.5 x 120	17.00	1.00
330000				63.5 x 120	17.00	1.50	76 x 120	14.80	1.50
470000				76 x 120	21.90	2.00			
1000000	63.5 x 140	40.00	1.50	63.5 x 140	35.00	1.50	76 x 140	30.00	1.50

Note: 1. Ripple Current: (A/rms) 85°C, 120Hz

2. Dissipation Factor: 120Hz / 20°C

**CASE SIZE & PERMISSIBLE RIPPLE CURRENT OF STANDARD PRODUCTS**

D x L: mm

CAP. (μF)	RATED VOLTAGE WV (SURGE VOLTAGE WV)								
	25 (32)			35 (44)			50 (63)		
	SIZE	RIPPLE CURRENT	DISSIPATION FACTOR	SIZE	RIPPLE CURRENT	DISSIPATION FACTOR	SIZE	RIPPLE CURRENT	DISSIPATION FACTOR
6800							35 x 50	3.60	0.25
10000				35 x 50	4.30	0.25	35 x 60	4.70	0.25
15000	35 x 50	4.40	0.35	35 x 80	6.20	0.25	35 x 80	6.20	0.25
22000	35 x 80	6.30	0.35	35 x 100	8.00	0.25	51 x 80	7.30	0.35
33000	35 x 100	8.30	0.35	51 x 80	9.00	0.35	51 x 80	9.00	0.35
47000	51 x 80	8.90	0.50	51 x 100	11.50	0.35	51 x 100	11.50	0.35
68000	51 x 80	10.80	0.50	51 x 120	14.60	0.35	63.5 x 100	12.70	0.50
100000	51 x 120	14.80	0.50	63.5 x 100	15.40	0.50	76 x 100	16.60	0.50
150000	63.5 x 120	16.20	0.75	76 x 120	21.40	0.50			
220000	76 x 120	21.20	0.75						
1000000	89 x 140	28.00	0.75						

Note: 1. Ripple Current: (A/rms) 85°C, 120Hz

2. Dissipation Factor: 120Hz / 20°C



## CASE SIZE & PERMISSIBLE RIPPLE CURRENT OF STANDARD PRODUCTS

D x L: mm

CAP. (μF)	RATED VOLTAGE WV (SURGE VOLTAGE WV)								
	63 (79)			80 (100)			100 (125)		
	SIZE	RIPPLE CURRENT	DISSIPATION FACTOR	SIZE	RIPPLE CURRENT	DISSIPATION FACTOR	SIZE	RIPPLE CURRENT	DISSIPATION FACTOR
2200							35 x 50	2.10	0.25
3300							35 x 80	3.00	0.25
4700	35 x 50	3.00	0.25	35 x 80	3.40	0.25	35 x 100	3.90	0.25
6800	35 x 60	3.90	0.25	35 x 80	4.30	0.25	35 x 120	4.90	0.25
10000	35 x 80	5.10	0.25	35 x 100	4.20	0.25	51 x 80	6.00	0.25
				51 x 80	6.00	0.30			
15000	51 x 80	6.70	0.35	51 x 100	7.00	0.30	51 x 120	8.30	0.25
22000	51 x 80	7.40	0.35	63.5 x 100	7.80	0.35	63.5 x 120	9.10	0.35
33000	51 x 100	9.70	0.35	76 x 100	10.50	0.40	76 x 120	12.00	0.35
47000	63.5 x 100	10.50	0.50	76 x 120	13.50	0.40			
100000	63.5 x 120	13.4	0.50						

Note: 1. Ripple Current: (A/rms) 85°C, 120Hz

2. Dissipation Factor: 120Hz / 20°C



## YAGEO - A GLOBAL COMPANY

### ASIA

**Beijing, China**  
Tel. +86 10 851 20810  
Fax. +86 10 851 20200

**Dongguan, China**  
Tel. +86 769 8772 0275  
Fax. +86 769 8791 0053

**Hong Kong, China**  
Tel. +852 2342 6833  
Fax. +852 2342 6588

**Qingdao, China**  
Tel. +86 157 2525 4907  
Fax. +86 512 6825 5568 x 2688

**Suzhou, China**  
Tel. +86 512 6825 5568  
Fax. +86 512 6825 5386

**Wuhan, China**  
Tel. +86 27 59838939  
Fax. +86 27 59838939

**Saitama, Japan**  
Tel. +81 48 795 8953  
Fax. +81 48 795 8954

**Kyunggi-Do, Korea**  
Tel. +82 31 712 4797  
Fax. +82 31 712 5866

**Kuala Lumpur, Malaysia**  
Tel. +60 3 8063 8864  
Fax. +60 3 8063 7376

**Singapore**  
Tel. +65 6244 7800  
Fax. +65 6244 4943

**Taipei, Taiwan**  
Tel. +886 2 2917 7555  
Fax. +886 2 2917 4286

### EUROPE

**Roermond, Benelux**  
Tel. +31 475 385 555  
Fax. +31 475 385 589

**Suresnes, France**  
Tel. +33 1 46 14 87 91  
Fax. +33 1 46 14 87 92

**Hamburg, Germany**  
Tel. +49 4121 870 189  
Fax. +49 4121 870 271

**Szombathely, Hungary**  
Tel. +36 30 3777 441  
Fax. +36 94 517 701

**Milan, Italy**  
Tel. +39 02 6129 1017  
Fax. +39 02 6601 7490

**Moscow, Russian Federation**  
Tel. +7 916 625 92 38  
Fax. +7 498 610 07 07

**Barcelona, Spain**  
Tel. +34 93 212 3929  
Fax. +39 02 6601 7490

**Berkshire, UK**  
Tel. +44 7767 346 607  
Fax. +31 475 385 589

### NORTH AMERICA

**San Jose, U.S.A.**  
Tel. +1 408 240 6200  
Fax. +1 408 240 6201

For more detailed and always up-to-date contact information of sales offices, distributors and representatives, please go to our website at

[www.yageo.com](http://www.yageo.com)

© YAGEO Corporation

All rights are reserved. Reproduction in whole or in part is prohibited without the prior written consent of the copyright owner.  
The information presented in this document does not form part of any quotation or contract, is believed to be accurate and reliable and may be changed without notice.  
No liability will be accepted by the publisher for any consequence of its use. Publication thereof does not convey nor imply any license under patent or other industrial or intellectual property rights.