

MM74HC540 • MM74HC541

Inverting Octal 3-STATE Buffer • Octal 3-STATE Buffer

General Description

The MM74HC540 and MM74HC541 3-STATE buffers utilize advanced silicon-gate CMOS technology. They possess high drive current outputs which enable high speed operation even when driving large bus capacitances. These circuits achieve speeds comparable to low power Schottky devices, while retaining the advantage of CMOS circuitry, i.e., high noise immunity, and low power consumption. Both devices have a fanout of 15 LS-TTL equivalent inputs.

The MM74HC540 is an inverting buffer and the MM74HC541 is a non-inverting buffer. The 3-STATE control gate operates as a two-input NOR such that if either $\overline{G1}$ or $\overline{G2}$ are HIGH, all eight outputs are in the high-impedance state.

In order to enhance PC board layout, the MM74HC540 and MM74HC541 offers a pinout having inputs and outputs on opposite sides of the package. All inputs are protected from damage due to static discharge by diodes to V_{CC} and ground.

Features

- Typical propagation delay: 12 ns
- 3-STATE outputs for connection to system buses
- Wide power supply range: 2–6V
- Low quiescent current: 80 μ A maximum (74HC Series)
- Output current: 6 mA

Ordering Code:

Order Number	Package Number	Package Description
MM74HC540WM	M20B	20-Lead Small Outline Integrated Circuit (SOIC), JEDEC MS-013, 0.300" Wide
MM74HC540SJ	M20D	20-Lead Small Outline Package (SOP), EIAJ TYPE II, 5.3mm Wide
MM74HC540MTC	MTC20	20-Lead Thin Shrink Small Outline Package (TSSOP), JEDEC MO-153, 4.4mm Wide
MM74HC540N	N20A	20-Lead Plastic Dual-In-Line Package (PDIP), JEDEC MS-001, 0.300" Wide
MM74HC541WM	M20B	20-Lead Small Outline Integrated Circuit (SOIC), JEDEC MS-013, 0.300" Wide
MM74HC541SJ	M20D	20-Lead Small Outline Package (SOP), EIAJ TYPE II, 5.3mm Wide
MM74HC541MTC	MTC20	20-Lead Thin Shrink Small Outline Package (TSSOP), JEDEC MO-153, 4.4mm Wide
MM74HC541N	N20A	20-Lead Plastic Dual-In-Line Package (PDIP), JEDEC MS-001, 0.300" Wide

Devices also available in Tape and Reel. Specify by appending the suffix letter "X" to the ordering code.

Connection Diagrams

Pin Assignments for DIP, SOIC, SOP and TSSOP

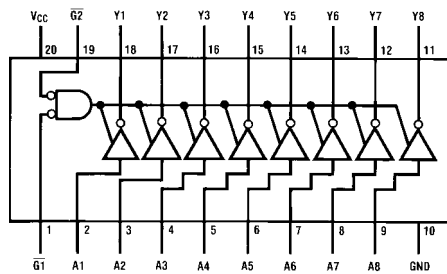

Top View
MM74HC540

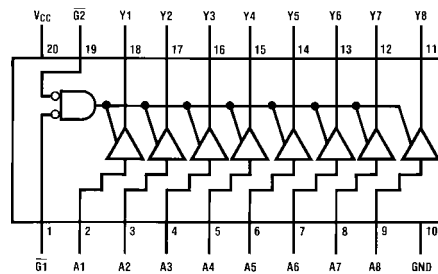

Top View
MM74HC541

Absolute Maximum Ratings (Note 1)

(Note 2)

Supply Voltage (V_{CC})	-0.5 to +7.0V
DC Input Voltage (V_{IN})	-1.5 to $V_{CC}+1.5V$
DC Output Voltage (V_{OUT})	-0.5 to $V_{CC}+0.5V$
Clamp Diode Current (I_{CD})	± 20 mA
DC Output Current, per pin (I_{OUT})	± 35 mA
DC V_{CC} or GND Current, per pin (I_{CC})	± 70 mA
Storage Temperature Range (T_{STG})	-65°C to +150°C
Power Dissipation (P_D)	
(Note 3)	600 mW
S.O. Package only	500 mW
Lead Temperature (T_L)	
(Soldering 10 seconds)	260°C

Recommended Operating Conditions

	Min	Max	Units
Supply Voltage (V_{CC})	2	6	V
DC Input or Output Voltage (V_{IN}, V_{OUT})	0	V_{CC}	V
Operating Temperature Range (T_A)	-40	+85	°C
Input Rise or Fall Times (t_r, t_f)			
$V_{CC} = 2.0V$		1000	ns
$V_{CC} = 4.5V$		500	ns
$V_{CC} = 6.0V$		400	ns

Note 1: Absolute Maximum Ratings are those values beyond which damage to the device may occur.

Note 2: Unless otherwise specified all voltages are referenced to ground.

Note 3: Power Dissipation temperature derating — plastic "N" package: -12 mW/°C from 65°C to 85°C.

DC Electrical Characteristics (Note 4)

Symbol	Parameter	Conditions	V_{CC}	$T_A = 25^\circ\text{C}$			Units	
				Typ	Guaranteed Limits			
V_{IH}	Minimum HIGH Level Input Voltage		2.0V		1.5	1.5	V	
			4.5V		3.15	3.15	V	
			6.0V		4.2	4.2	V	
V_{IL}	Maximum LOW Level Input Voltage		2.0V		0.5	0.5	V	
			4.5V		1.35	1.35	V	
			6.0V		1.8	1.8	V	
V_{OH}	Minimum HIGH Level Output Voltage	$V_{IN} = V_{IH}$ or V_{IL} $ I_{OUT} \leq 20 \mu\text{A}$	2.0V	2.0	1.9	1.9	V	
			4.5V	4.5	4.4	4.4	V	
			6.0V	6.0	5.9	5.9	V	
		$V_{IN} = V_{IH}$ or V_{IL} $ I_{OUT} \leq 6.0 \text{ mA}$ $ I_{OUT} \leq 7.8 \text{ mA}$	4.5V	4.2	3.98	3.84	3.7	V
			6.0V	5.7	5.48	5.34	5.2	V
V_{OL}	Maximum LOW Level Output Voltage	$V_{IN} = V_{IH}$ or V_{IL} $ I_{OUT} \leq 20 \mu\text{A}$	2.0V	0	0.1	0.1	V	
			4.5V	0	0.1	0.1	V	
			6.0V	0	0.1	0.1	V	
		$V_{IN} = V_{IH}$ or V_{IL} $ I_{OUT} \leq 6.0 \text{ mA}$ $ I_{OUT} \leq 7.8 \text{ mA}$	4.5V	0.2	0.26	0.33	0.4	V
			6.0V	0.2	0.26	0.33	0.4	V
I_{IN}	Maximum Input Current	$V_{IN} = V_{CC}$ or GND	6.0V		± 0.1	± 1.0	μA	
I_{OZ}	Maximum 3-STATE Output Leakage Current	$V_{IN} = V_{IH}$ or $V_{IL}, \bar{G} = V_{IH}$ $V_{OUT} = V_{CC}$ or GND	6.0V		± 0.5	± 5	μA	
I_{CC}	Maximum Quiescent Supply Current	$V_{IN} = V_{CC}$ or GND $I_{OUT} = 0 \mu\text{A}$	6.0V		8.0	80	160	μA

Note 4: For a power supply of $5V \pm 10\%$ the worst case output voltages (V_{OH} , and V_{OL}) occur for HC at 4.5V. Thus the 4.5V values should be used when designing with this supply. Worst case V_{IH} and V_{IL} occur at $V_{CC} = 5.5V$ and 4.5V respectively. (The V_{IH} value at 5.5V is 3.85V.) The worst case leakage current (I_{IN} , I_{CC} , and I_{OZ}) occur for CMOS at the higher voltage and so the 6.0V values should be used.

AC Electrical Characteristics					
$V_{CC} = 5V, T_A = 25^\circ C, t_r = t_f = 6 \text{ ns}$					
Symbol	Parameter	Conditions	Typ	Guaranteed Limit	Units
t_{PHL}, t_{PLH}	Maximum Propagation Delay (540)	$C_L = 45 \text{ pF}$	12	18	ns
t_{PHL}, t_{PLH}	Maximum Propagation Delay (541)	$C_L = 45 \text{ pF}$	14	20	ns
t_{PZH}, t_{PZL}	Maximum Output Enable Time	$R_L = 1 \text{ k}\Omega$ $C_L = 45 \text{ pF}$	17	28	ns
t_{PHZ}, t_{PLZ}	Maximum Output Disable Time	$R_L = 1 \text{ k}\Omega$ $C_L = 5 \text{ pF}$	15	25	ns

AC Electrical Characteristics								
$V_{CC} = 2.0V \text{ to } 6.0V, C_L = 50 \text{ pF}, t_r = t_f = 6 \text{ ns}$ (unless otherwise specified)								
Symbol	Parameter	Conditions	V_{CC}	$T_A = 25^\circ C$		$T_A = -40 \text{ to } 85^\circ C$	$T_A = -55 \text{ to } 125^\circ C$	Units
				Typ	Guaranteed Limits			
t_{PHL}, t_{PLH}	Maximum Propagation Delay (540)	$C_L = 50 \text{ pF}$	2.0V	55	100	126	149	ns
			2.0V	83	150	190	224	ns
		$C_L = 150 \text{ pF}$	4.5V	12	20	25	30	ns
			4.5V	22	30	38	45	ns
		6.0V	11	17	21	25	ns	
6.0V	18	26	32	38	ns			
t_{PHL}, t_{PLH}	Maximum Propagation Delay (541)	$C_L = 50 \text{ pF}$	2.0V	58	115	145	171	ns
			2.0V	83	165	208	246	ns
		$C_L = 150 \text{ pF}$	4.5V	14	23	29	34	ns
			4.5V	17	33	42	49	ns
		6.0V	11	20	25	29	ns	
6.0V	14	28	35	42	ns			
t_{PZH}, t_{PZL}	Maximum Output Enable Time	$R_L = 1 \text{ k}\Omega$	2.0V	75	150	189	224	ns
				100	200	252	298	ns
		$C_L = 50 \text{ pF}$	4.5V	15	30	38	45	ns
			4.5V	30	40	50	60	ns
		$C_L = 150 \text{ pF}$	6.0V	13	26	32	38	ns
			6.0V	17	34	43	51	ns
t_{PHZ}, t_{PLZ}	Maximum Output Disable Time	$R_L = 1 \text{ k}\Omega$	2.0V	75	150	189	224	ns
			4.5V	15	30	38	45	ns
			6.0V	13	26	32	38	ns
t_{THL}, t_{TLH}	Maximum Output Rise and Fall Time	$C_L = 50 \text{ pF}$	2.0V	25	60	75	90	ns
			4.5V	7	12	15	18	ns
			6.0V	6	10	13	15	ns
C_{PD}	Power Dissipation Capacitance (Note 5)	$\bar{G} = V_{IH}$ $\bar{G} = V_{IL}$		10				pF
				50				pF
C_{IN}	Maximum Input Capacitance			5	10	10	10	pF
C_{OUT}	Maximum Output Capacitance			15	20	20	20	pF

Note 5: C_{PD} determines the no load dynamic power consumption, $P_D = C_{PD} V_{CC}^2 f + I_{CC} V_{CC}$, and the no load dynamic current consumption, $I_S = C_{PD} V_{CC} f + I_{CC}$.

Physical Dimensions inches (millimeters) unless otherwise noted

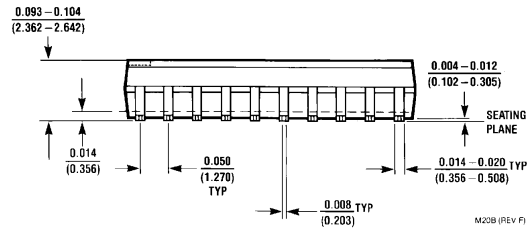
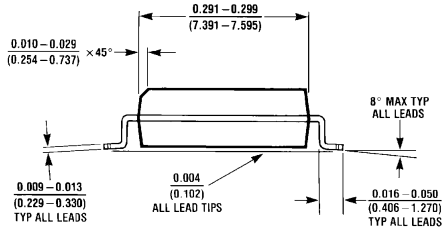
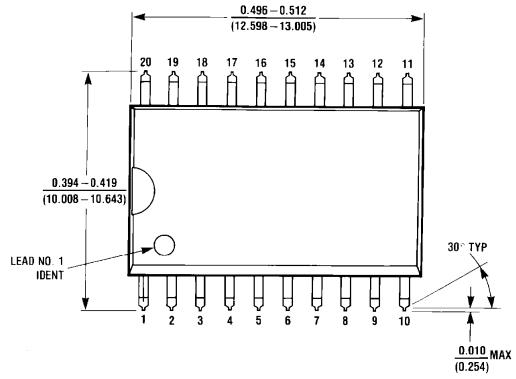

**20-Lead Small Outline Integrated Circuit (SOIC), JEDEC MS-013, 0.300" Wide
Package Number M20B**

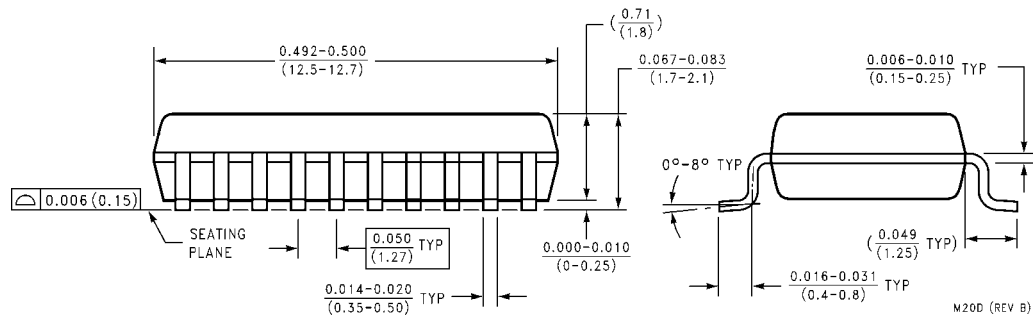
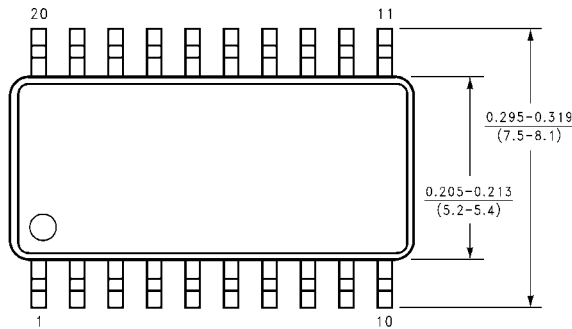

**20-Lead Small Outline Package (SOP), EIAJ TYPE II, 5.3mm Wide
Package Number M20D**

Physical Dimensions inches (millimeters) unless otherwise noted (Continued)

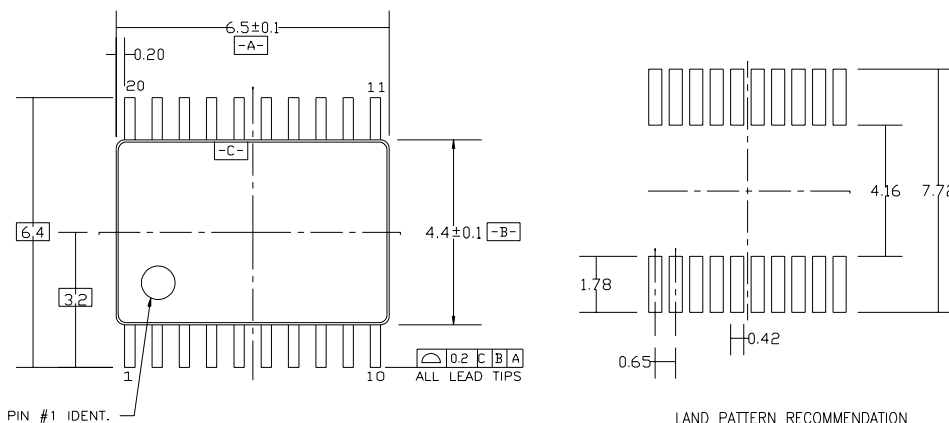

LAND PATTERN RECOMMENDATION

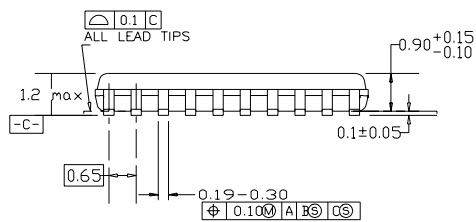

DIMENSIONS ARE IN MILLIMETERS

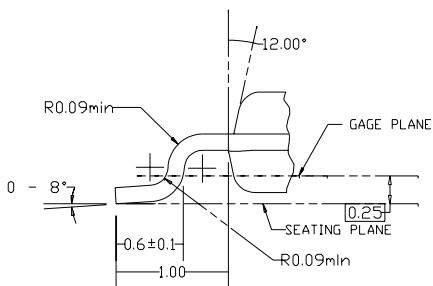
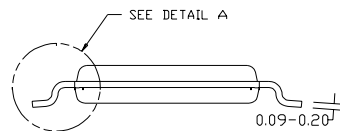

DETAIL A

NOTES:

- A. CONFORMS TO JEDEC REGISTRATION MO-153, VARIATION AC, REF NOTE 6, DATE 7/93.
- B. DIMENSIONS ARE IN MILLIMETERS.
- C. DIMENSIONS ARE EXCLUSIVE OF BURRS, MOLDS FLASH, AND TIE BAR EXTRUSIONS.
- D. DIMENSIONS AND TOLERANCES PER ANSI Y14.5M, 1982.

**20-Lead Thin Shrink Small Outline Package (TSSOP), JEDEC MO-153, 4.4mm Wide
Package Number MTC20**

Physical Dimensions inches (millimeters) unless otherwise noted (Continued)

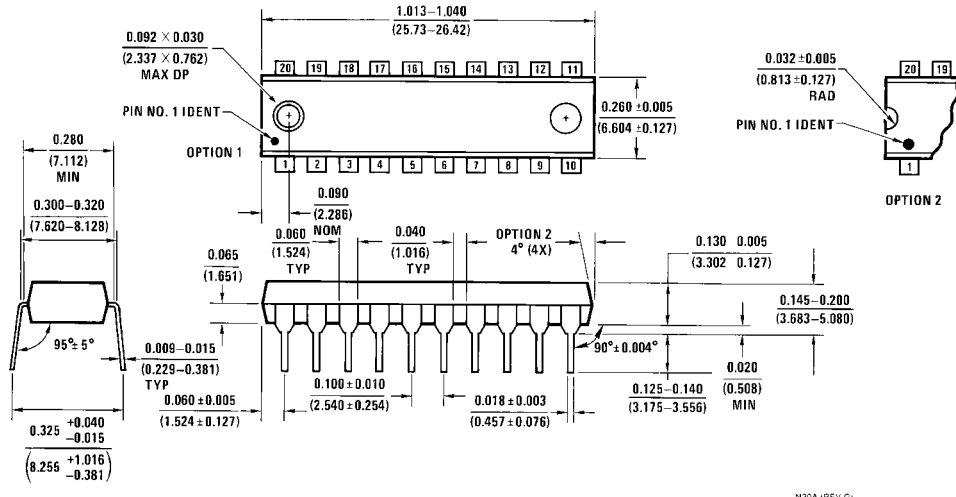

20-Lead Plastic Dual-In-Line Package (PDIP), JEDEC MS-001, 0.300" Wide
Package Number N20A

LIFE SUPPORT POLICY

FAIRCHILD'S PRODUCTS ARE NOT AUTHORIZED FOR USE AS CRITICAL COMPONENTS IN LIFE SUPPORT DEVICES OR SYSTEMS WITHOUT THE EXPRESS WRITTEN APPROVAL OF THE PRESIDENT OF FAIRCHILD SEMICONDUCTOR CORPORATION. As used herein:

1. Life support devices or systems are devices or systems which, (a) are intended for surgical implant into the body, or (b) support or sustain life, and (c) whose failure to perform when properly used in accordance with instructions for use provided in the labeling, can be reasonably expected to result in a significant injury to the user.
2. A critical component in any component of a life support device or system whose failure to perform can be reasonably expected to cause the failure of the life support device or system, or to affect its safety or effectiveness.

www.fairchildsemi.com