



*DC COMPONENTS CO., LTD.*

RECTIFIER SPECIALISTS

UF4001  
THRU  
UF4007

**TECHNICAL SPECIFICATION OF ULTRA FAST RECTIFIER**

**VOLTAGE RANGE - 50 to 1000 Volts**

**CURRENT - 4.0 Amperes**

**FEATURES**

- \* Low power loss, high efficiency
- \* Low forward voltage drop
- \* High current capability
- \* Ultra fast switching
- \* High surge capability
- \* High reliability

**MECHANICAL DATA**

- \* Case: Molded plastic
- \* Epoxy: UL 94V-0 rate flame retardant
- \* Lead: MIL-STD-202E, Method 208 guaranteed
- \* Polarity: Color band denotes cathode end
- \* Mounting position: Any
- \* Weight: 2.08 grams



DO-41

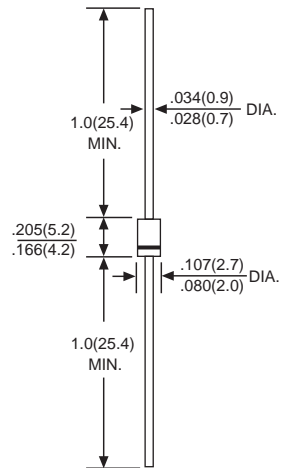

Dimensions in inches and (millimeters)

**MAXIMUM RATINGS AND ELECTRICAL CHARACTERISTICS**

Ratings at 25° C ambient temperature unless otherwise specified.  
Single phase, half wave, 60Hz, resistive or inductive load.  
For capacitive load, derate current by 20%.

	SYMBOL	UF4001	UF4002	UF4003	UF4004	UF4005	UF4006	UF4007	UNITS
Maximum Recurrent Peak Reverse Voltage	V <sub>RRM</sub>	50	100	200	400	600	800	1000	Volts
Maximum RMS Voltage	V <sub>RMS</sub>	35	70	140	280	420	560	700	Volts
Maximum DC Blocking Voltage	V <sub>DC</sub>	50	100	200	400	600	800	1000	Volts
Maximum Average Forward Rectified Current at TA= 50°C	I <sub>O</sub>	1.0							Amps
Peak Forward Surge Current 8.3 ms single half sine-wave superimposed on rated load (JEDEC Method)	I <sub>FSM</sub>	30							Amps
Maximum Instantaneous Forward Voltage at 1.0A DC	V <sub>F</sub>	1.0			1.7				Volts
Maximum DC Reverse Current at Rated DC Blocking Voltage TA = 25°C	I <sub>R</sub>	5.0							uAmps
Maximum Full Load Reverse Current Average, Full Cycle .375"(9.5mm) lead length at TL = 55°C		100							uAmps
Maximum Reverse Recovery Time (Note 1)	t <sub>rr</sub>	50				75			nSec
Typical Junction Capacitance (Note 2)	C <sub>J</sub>	15			12				pF
Operating and Storage Temperature Range	T <sub>J</sub> , T <sub>STG</sub>	-65 to + 150							°C

NOTES : 1. Test Conditions: I<sub>F</sub> = 0.5A, I<sub>R</sub> = 1.0A, I<sub>RR</sub> = 0.25A  
2. Measured at 1 MHz and applied reverse voltage of 4.0 volts

# RATING AND CHARACTERISTIC CURVES ( UF4001 THRU UF4007 )

FIG. 1 - TEST CIRCUIT DIAGRAM AND REVERSE RECOVERY TIME CHARACTERISTIC

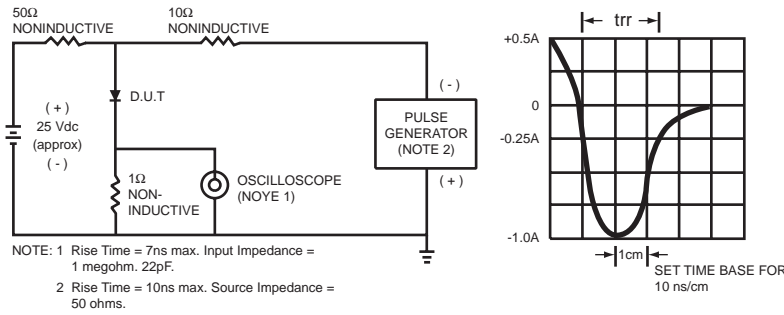

FIG. 2 - TYPICAL FORWARD CURRENT DERATING CURVE

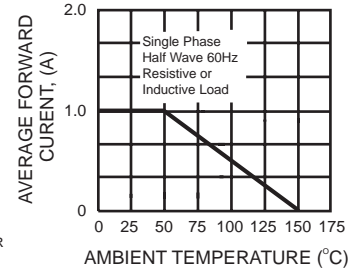

FIG. 3 - TYPICAL REVERSE CHARACTERISTICS

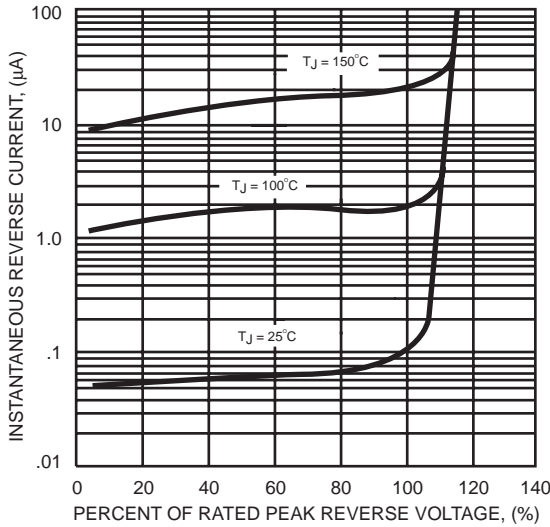

FIG. 4 - TYPICAL INSTANTANEOUS FORWARD CHARACTERISTICS

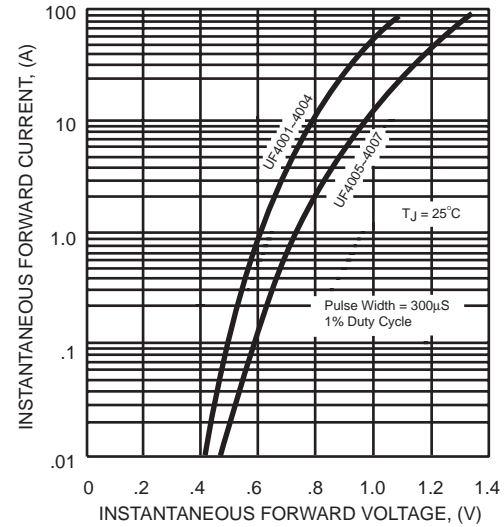

FIG. 5 - MAXIMUM NON-REPETITIVE FORWARD SURGE CURRENT

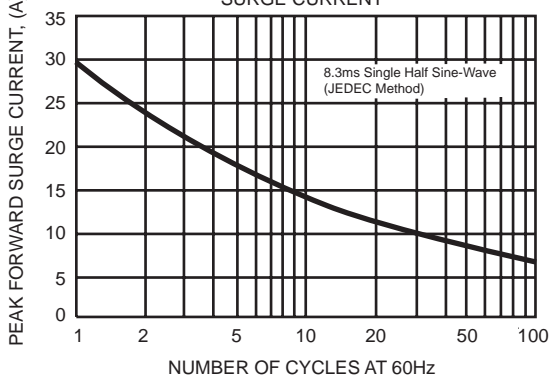
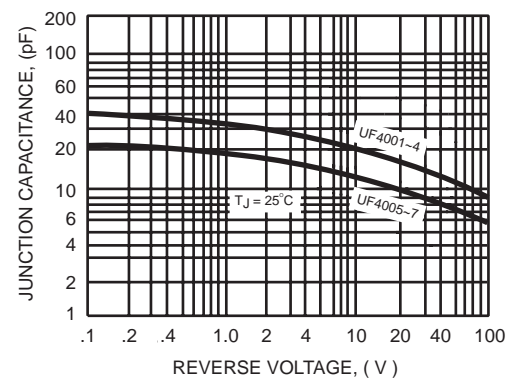

FIG. 6 - TYPICAL JUNCTION CAPACITANCE



DC COMPONENTS CO., LTD.