



## Screwless end stop; 6 mm wide

Item No.: 249-116



Screwless end stop; 6 mm wide

### Marking

RoHS ✓  
Compliant

### Business data

Supplier	WAGO
Item no.	249-116
GTIN / EAN	4017332270823
Content	1
Order amount	25
Customer item number	

### Notes

*Fit – and forget! Assembling the new WAGO screwless end stop is as simple and quick as snapping a WAGO rail-mount terminal block onto the rail. Without any tools! This allows rail-mount terminal blocks to be safely secured, at low cost, against any movement on all DIN-35 rails per DIN EN 50022 (35 x 7.5 mm; 35 x 15 mm). Entirely without screws! The “secret” of the excellent tight fit lies in the two small clamping plates which keep the end stop in position, even if the rails are mounted vertically. Simply snap on and forget! In addition, costs are considerably reduced when using large numbers of end stops. A further advantage is that three marker slots for all WAGO marker systems for rail-mount terminal blocks and a snap-in hole for WAGO adjustable height group marker carriers offer individual marking possibilities.*

### Technical data

Miscellaneous

<b>Technical data</b>	
<i>Color</i>	<i>gray</i>
<i>Fire load [MJ]</i>	<i>0.105 [MJ]</i>
<i>Weight [g]</i>	<i>3.46 [g]</i>
<i>Width</i>	<i>6 mm / 0.236 in.</i>
<i>Height from upper-edge of DIN-35 rail</i>	<i>28.2 mm / 1.11 in.</i>
<i>Depth</i>	<i>45 mm / 1.772 in.</i>
<i>Type of mounting</i>	<i>DIN-35 rail</i>

Images & drawings

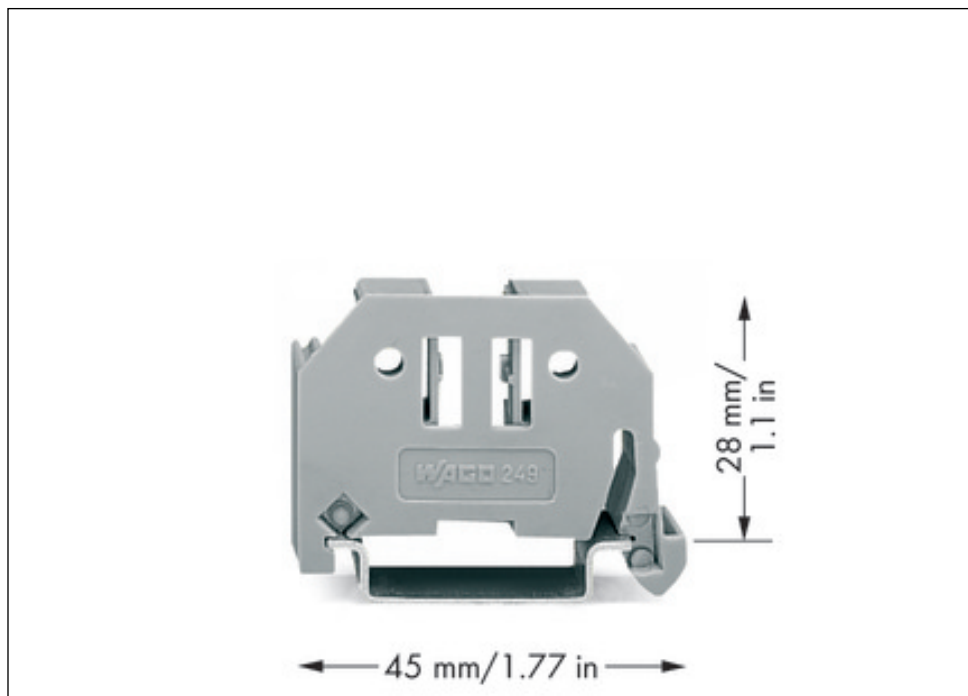
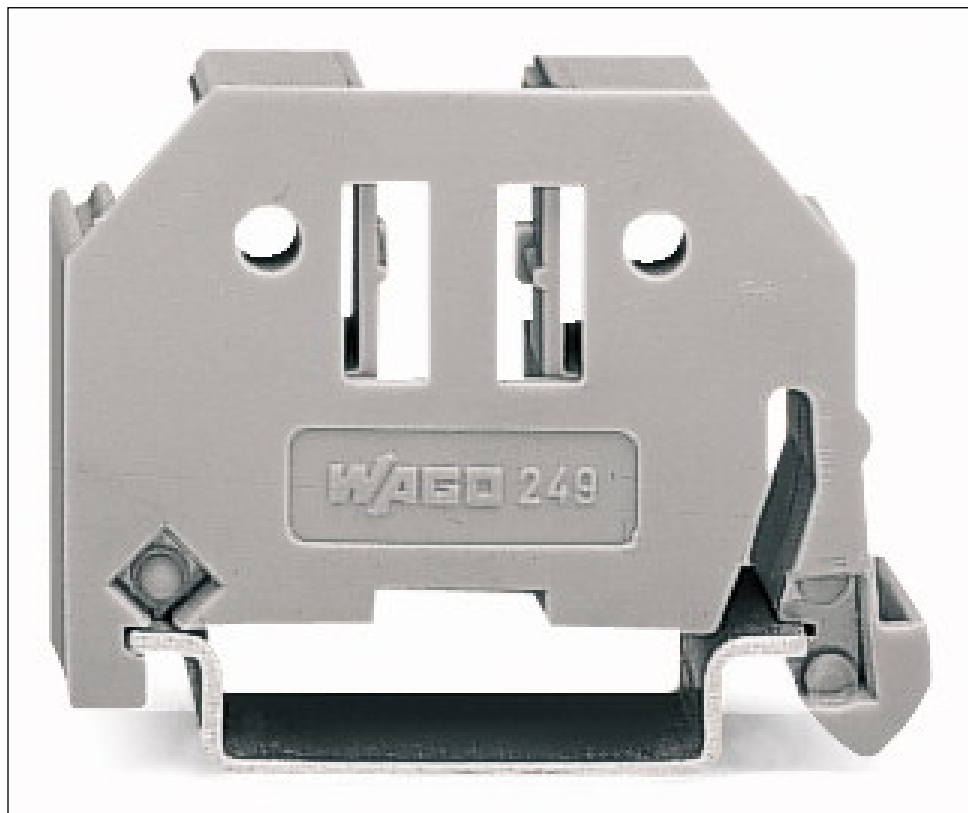

**Address**

WAGO Kontakttechnik GmbH & Co. KG

Hansastr. 27

32423 Minden

Telefon: 0571/887-0

Fax: 0571/887-169

<http://www.wago.com>

© WAGO Kontakttechnik GmbH & Co. KG

Technische Änderungen und Irrtümer vorbehalten.