

# SMD Wire Wound Chip Inductors

# LCN Series

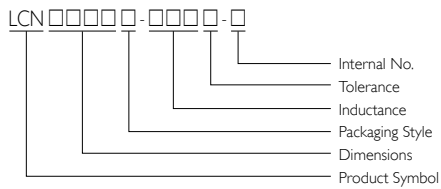

## PRODUCT IDENTIFICATION



■ Packaging: T = Tape and Reel

## APPLICATIONS

RF products for Cellular Phone, GPS Receiver, Base Station, Repeater, Wireless LAN/Mouse/Keyboard/ Earphone, Remote Control, Security System and other RF modules.

## OUTLINE

Based on our technical expertise and skill in accurately winding, these chip inductors are designed as filtering, impedance matching, resonance and choke circuits for RF designers.

The standard series as well as custom design to meet your needs of telecom & wireless products.

## FEATURES

Ceramic body and wire wound construction provide highest SRFs.

These ultra-compact inductors provide exceptional Q values, even at high frequencies.

Their ceramic construction delivers the highest possible SRFs as well as excellent Q values.

The non-magnetic coil form also assures the utmost in thermal stability, predictability and batch consistency.

LCN series has been designed especially for the needs of customer design.

## SHAPES AND DIMENSIONS

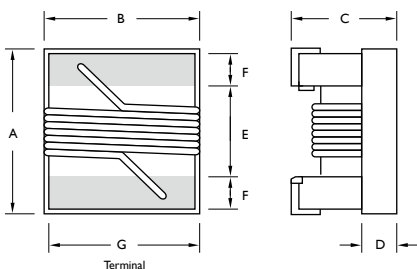

TYPE	UNIT	A	B	C	D	E	F	G
		Max.	Max.	Max.				
LCN0603	inch	0.071	0.044	0.040	0.015	0.034	0.013	0.030
	mm	1.80	1.12	1.02	0.38	0.86	0.33	0.76
LCN0805	inch	0.093	0.068	0.060	0.020	0.040	0.020	0.050
	mm	2.35	1.73	1.52	0.50	1.02	0.51	1.27
LCN1008	inch	0.115	0.110	0.083	0.020	0.060	0.020	0.080
	mm	2.92	2.79	2.10	0.51	1.52	0.51	2.03
LCN1206	inch	0.146	0.110	0.087	0.035	0.086	0.020	0.091
	mm	3.70	2.80	2.20	0.90	2.18	0.51	2.30

## ELECTRICAL CHARACTERISTICS LCN0603

PART NO.	INDUCTANCE (nH)	TOLERANCE (±%)	TEST FREQUENCY (MHz)	Q Min.	SRF (MHz) Min.	DC RESISTANCE (Ω) Max.	I <sub>rms</sub> (mA) Max.	900MHz		1.7GHz		COLOR CODING
								L Typ.	Q Typ.	L Typ.	Q Typ.	
LCN0603T-1N6□-S	1.6	5 / 10	250	24	12,500	0.030	700	1.60	49	1.58	63	Red
LCN0603T-1N8□-S	1.8	5 / 10	250	16	12,500	0.045	700	1.60	35	1.66	50	Black
LCN0603T-3N6□-S	3.6	5 / 10	250	22	5,900	0.063	700	3.70	53	3.71	65	Red
LCN0603T-3N9□-S	3.9	5 / 10	250	22	6,900	0.080	700	3.95	49	3.96	67	Brown
LCN0603T-4N3□-S	4.3	5 / 10	250	22	5,900	0.063	700	4.32	50	4.33	70	Orange
LCN0603T-4N7□-S	4.7	5 / 10	250	20	5,800	0.116	700	4.72	47	4.75	57	Violet
LCN0603T-5N1□-S	5.1	5 / 10	250	20	5,700	0.140	700	4.93	47	4.95	56	Green
LCN0603T-6N3□-S	6.3	5 / 10	250	20	5,700	0.140	700	5.50	47	6.10	60	White
LCN0603T-6N8□-S	6.8	5 / 10	250	27	5,800	0.110	700	6.75	60	7.10	81	Red
LCN0603T-7N5□-S	7.5	5 / 10	250	28	4,800	0.106	700	7.70	60	7.82	65	Brown
LCN0603T-8N2□-S	8.2	5 / 10	250	28	4,700	0.109	700	8.30	60	8.50	60	White
LCN0603T-8N7□-S	8.7	5 / 10	250	28	4,600	0.109	700	8.86	62	9.32	58	Yellow
LCN0603T-9N5□-S	9.5	5 / 10	250	28	5,400	0.135	700	9.70	59	9.92	61	Blue
LCN0603T-10N□-S	10	2 / 5 / 10	250	31	4,800	0.130	700	10.0	66	10.6	83	Orange
LCN0603T-11N□-S	11	2 / 5 / 10	250	33	4,000	0.086	700	11.0	53	11.5	56	Gray
LCN0603T-12N□-S	12	2 / 5 / 10	250	35	4,000	0.130	700	12.3	72	13.5	83	Yellow
LCN0603T-15N□-S	15	2 / 5 / 10	250	35	4,000	0.170	700	15.4	64	16.8	89	Green
LCN0603T-16N□-S	16	2 / 5 / 10	250	34	3,300	0.104	700	16.2	55	17.3	52	White
LCN0603T-18N□-S	18	2 / 5 / 10	250	35	3,100	0.170	700	18.7	70	21.4	69	Blue
LCN0603T-22N□-S	22	2 / 5 / 10	250	38	3,000	0.190	700	22.8	73	26.1	71	Violet
LCN0603T-24N□-S	24	2 / 5 / 10	250	37	2,650	0.135	700	24.5	45	28.7	39	Black
LCN0603T-27N□-S	27	2 / 5 / 10	250	40	2,800	0.220	600	29.2	74	34.6	65	Gray
LCN0603T-30N□-S	30	2 / 5 / 10	250	37	2,250	0.144	600	31.4	47	39.9	28	Brown
LCN0603T-33N□-S	33	2 / 5 / 10	250	40	2,300	0.220	600	36.0	67	49.5	42	White
LCN0603T-36N□-S	36	2 / 5 / 10	250	38	2,080	0.250	600	39.4	47	52.7	24	Red
LCN0603T-39N□-S	39	2 / 5 / 10	250	40	2,200	0.250	600	42.7	60	60.2	40	Black
LCN0603T-43N□-S	43	2 / 5 / 10	250	39	2,000	0.280	600	47.0	44	64.9	21	Orange
LCN0603T-47N□-S	47	2 / 5 / 10	200	38	2,000	0.280	600	52.2	62	77.2	35	Brown
LCN0603T-56N□-S	56	2 / 5 / 10	200	38	1,900	0.310	600	62.5	56	97	26	Red
LCN0603T-68N□-S	68	2 / 5 / 10	200	37	1,700	0.340	600	80.5	54	168	21	Orange
LCN0603T-72N□-S	72	2 / 5 / 10	150	34	1,700	0.490	400	82.0	53	135	20	Yellow
LCN0603T-82N□-S	82	2 / 5 / 10	150	34	1,700	0.540	400	96.2	54	177	21	Green
LCN0603T-R10□-S	100	2 / 5 / 10	150	34	1,400	0.580	400	124	49	-	-	Blue
LCN0603T-R11□-S	110	2 / 5 / 10	150	32	1,350	0.610	300	138	43	-	-	Violet
LCN0603T-R12□-S	120	2 / 5 / 10	150	32	1,300	0.750	300	166	39	-	-	Gray
LCN0603T-R15□-S	150	2 / 5 / 10	150	28	990	0.920	280	250	25	-	-	White
LCN0603T-R18□-S	180	2 / 5 / 10	100	25	990	1.250	240	305	22	-	-	Black
LCN0603T-R22□-S	220	2 / 5 / 10	100	25	900	2.100	200	480	8	-	-	Brown
LCN0603T-R27□-S	270	2 / 5 / 10	100	24	900	2.300	170	980	4	-	-	Red

## Note:

When ordering, please specify tolerance and packaging codes.

Tolerance: G = ± 2%, J = ± 5%, K = ± 10%

Packaging: Clear tape and reel (standard)

Test Instruments: L/Q- Agilent/HP4291A+Agilent/HP16197A

SRF- HP8753D/HP4291A

RDC- CH502BC/HP4338B

I<sub>rms</sub>- For a 15 °C rise above 25 °C ambient.

Operating Temperature Range: -40 °C to +125 °C



## ELECTRICAL CHARACTERISTICS LCN0805

PART NO.	INDUCTANCE (nH)	TOLERANCE (±%)	TEST FREQUENCY (MHz)	Q Min.	TEST FREQUENCY (MHz)	SRF (MHz) Min.	DC RESISTANCE (Ω) Max.	I <sub>rms</sub> (mA) Max.	COLOR CODING
LCN0805T-2N8□-S	2.8	5 / 10	250	70	1500	7,900	0.06	800	Gray
LCN0805T-3N0□-S	3.0	5 / 10	250	65	1500	7,900	0.06	800	White
LCN0805T-3N3□-S	3.3	5 / 10	250	50	1500	7,900	0.08	600	Black
LCN0805T-5N6□-S	5.6	5 / 10	250	65	1000	5,500	0.08	600	Orange
LCN0805T-6N8□-S	6.8	5 / 10	250	50	1000	5,500	0.11	600	Brown
LCN0805T-7N5□-S	7.5	5 / 10	250	50	1000	4,500	0.14	600	Green
LCN0805T-8N2□-S	8.2	5 / 10	250	50	1000	4,700	0.12	600	Red
LCN0805T-10N□-S	10	2 / 5 / 10	250	60	500	4,200	0.10	600	Blue
LCN0805T-12N□-S	12	2 / 5 / 10	250	50	500	4,000	0.15	600	Orange
LCN0805T-15N□-S	15	2 / 5 / 10	250	50	500	3,400	0.17	600	Yellow
LCN0805T-18N□-S	18	2 / 5 / 10	250	50	500	3,300	0.20	600	Green
LCN0805T-22N□-S	22	2 / 5 / 10	250	55	500	2,600	0.22	500	Blue
LCN0805T-24N□-S	24	2 / 5 / 10	250	50	500	2,000	0.22	500	Gray
LCN0805T-27N□-S	27	2 / 5 / 10	250	55	500	2,500	0.25	500	Violet
LCN0805T-33N□-S	33	2 / 5 / 10	250	60	500	2,050	0.27	500	Gray
LCN0805T-36N□-S	36	2 / 5 / 10	250	55	500	1,700	0.27	500	Orange
LCN0805T-39N□-S	39	2 / 5 / 10	250	60	500	2,000	0.29	500	White
LCN0805T-43N□-S	43	2 / 5 / 10	200	60	500	1,650	0.34	500	Yellow
LCN0805T-47N□-S	47	2 / 5 / 10	200	60	500	1,650	0.31	500	Black
LCN0805T-56N□-S	56	2 / 5 / 10	200	60	500	1,550	0.34	500	Brown
LCN0805T-68N□-S	68	2 / 5 / 10	200	60	500	1,450	0.38	500	Red
LCN0805T-82N□-S	82	2 / 5 / 10	150	65	500	1,300	0.42	400	Orange
LCN0805T-91N□-S	91	2 / 5 / 10	150	65	500	1,200	0.48	400	Black
LCN0805T-R10□-S	100	2 / 5 / 10	150	65	500	1,200	0.46	400	Yellow
LCN0805T-R11□-S	110	2 / 5 / 10	150	50	250	1,000	0.48	400	Brown
LCN0805T-R12□-S	120	2 / 5 / 10	150	50	250	1,100	0.51	400	Green
LCN0805T-R15□-S	150	2 / 5 / 10	100	50	250	920	0.56	400	Blue
LCN0805T-R18□-S	180	2 / 5 / 10	100	50	250	870	0.64	400	Violet
LCN0805T-R20□-S	200	2 / 5 / 10	100	50	250	860	0.70	400	Red
LCN0805T-R22□-S	220	2 / 5 / 10	100	50	250	850	0.70	400	Gray
LCN0805T-R24□-S	240	2 / 5 / 10	100	44	250	690	1.00	350	Red
LCN0805T-R25□-S	250	2 / 5 / 10	100	45	250	660	1.00	350	Yellow
LCN0805T-R27□-S	270	2 / 5 / 10	100	48	250	650	1.00	350	White
LCN0805T-R33□-S	330	2 / 5 / 10	100	48	250	600	1.40	310	Black
LCN0805T-R39□-S	390	2 / 5 / 10	100	25	250	400	1.50	290	Brown
LCN0805T-R47□-S	470	2 / 5 / 10	50	33	100	400	1.76	250	Violet
LCN0805T-R56□-S	560	2 / 5 / 10	25	20	50	200	1.90	230	Orange
LCN0805T-R68□-S	680	2 / 5 / 10	25	18	50	130	2.20	190	Green
LCN0805T-R82□-S	820	2 / 5 / 10	25	15	50	100	2.35	180	Blue

### Note:

When ordering, please specify tolerance and packaging codes.

Tolerance: G = ± 2%, J = ± 5%, K = ± 10%

Packaging: Clear tape and reel (standard)

Test Instruments: L/Q- Agilent/HP4291A+Agilent/HP16197A

SRF- HP8753D/HP4291A

RDC- CH502BC/HP4338B

I<sub>rms</sub>- For a 15 °C rise above 25 °C ambient.

Operating Temperature Range: -40 °C to +125 °C

**ELECTRICAL CHARACTERISTICS** LCN1008

PART NO.	INDUCTANCE (nH)	TOLERANCE (±%)	TEST FREQUENCY (MHz)	Q Min.	TEST FREQUENCY (MHz)	SRF (MHz) Min.	DC RESISTANCE (Ω) Max.	I <sub>rms</sub> (mA) Max.	COLOR CODING		
									1 <sup>st</sup>	2 <sup>nd</sup>	3 <sup>rd</sup>
LCN1008T-10N□-S	10	2 / 5 / 10	50	50	500	4,100	0.08	1,000	Brown	Black	Black
LCN1008T-12N□-S	12	2 / 5 / 10	50	50	500	3,300	0.09	1,000	Brown	Red	Black
LCN1008T-15N□-S	15	2 / 5 / 10	50	50	500	2,500	0.10	1,000	Brown	Green	Black
LCN1008T-18N□-S	18	2 / 5 / 10	50	50	350	2,500	0.11	1,000	Brown	Gray	Black
LCN1008T-22N□-S	22	2 / 5 / 10	50	55	350	2,400	0.12	1,000	Red	Red	Black
LCN1008T-27N□-S	27	2 / 5 / 10	50	55	350	1,600	0.13	1,000	Red	Violet	Black
LCN1008T-33N□-S	33	2 / 5 / 10	50	60	350	1,600	0.14	1,000	Orange	Orange	Black
LCN1008T-39N□-S	39	2 / 5 / 10	50	60	350	1,500	0.15	1,000	Orange	White	Black
LCN1008T-47N□-S	47	2 / 5 / 10	50	65	350	1,500	0.16	1,000	Yellow	Violet	Black
LCN1008T-56N□-S	56	2 / 5 / 10	50	65	350	1,300	0.18	1,000	Green	Blue	Black
LCN1008T-68N□-S	68	2 / 5 / 10	50	65	350	1,300	0.20	1,000	Blue	Gray	Black
LCN1008T-82N□-S	82	2 / 5 / 10	50	60	350	1,000	0.22	1,000	Gray	Red	Black
LCN1008T-R10□-S	100	2 / 5 / 10	25	60	350	1,000	0.56	650	Brown	Black	Brown
LCN1008T-R12□-S	120	2 / 5 / 10	25	60	350	950	0.63	650	Brown	Red	Brown
LCN1008T-R15□-S	150	2 / 5 / 10	25	45	100	850	0.70	580	Brown	Green	Brown
LCN1008T-R18□-S	180	2 / 5 / 10	25	45	100	750	0.77	620	Brown	Gray	Brown
LCN1008T-R22□-S	220	2 / 5 / 10	25	45	100	700	0.84	500	Red	Red	Brown
LCN1008T-R27□-S	270	2 / 5 / 10	25	45	100	600	0.91	500	Red	Violet	Brown
LCN1008T-R33□-S	330	2 / 5 / 10	25	45	100	570	1.05	450	Orange	Orange	Brown
LCN1008T-R39□-S	390	2 / 5 / 10	25	45	100	500	1.12	470	Orange	White	Brown
LCN1008T-R47□-S	470	2 / 5 / 10	25	45	100	450	1.19	470	Yellow	Violet	Brown
LCN1008T-R56□-S	560	2 / 5 / 10	25	45	100	415	1.33	400	Green	Blue	Brown
LCN1008T-R62□-S	620	2 / 5 / 10	25	45	100	375	1.40	300	Blue	Red	Brown
LCN1008T-R68□-S	680	2 / 5 / 10	25	45	100	375	1.47	400	Blue	Gray	Brown
LCN1008T-R75□-S	750	2 / 5 / 10	25	45	100	360	1.54	360	Violet	Green	Brown
LCN1008T-R82□-S	820	2 / 5 / 10	25	45	100	350	1.61	400	Gray	Red	Brown
LCN1008T-R91□-S	910	2 / 5 / 10	25	35	50	320	1.68	380	White	Brown	Brown
LCN1008T-1R0□-S	1,000	2 / 5 / 10	25	35	50	220	1.75	370	Brown	Black	Red
LCN1008T-1R2□-S	1,200	2 / 5 / 10	7.90	35	50	186	2.00	310	Brown	Red	Red
LCN1008T-1R5□-S	1,500	2 / 5 / 10	7.90	28	50	200	2.30	330	Brown	Green	Red
LCN1008T-1R8□-S	1,800	2 / 5 / 10	7.90	25	50	170	2.60	300	Brown	Gray	Red
LCN1008T-2R2□-S	2,200	2 / 5 / 10	7.90	20	50	110	2.80	280	Red	Red	Red
LCN1008T-2R7□-S	2,700	2 / 5 / 10	7.90	15	25	140	3.20	290	Red	Violet	Red
LCN1008T-3R3□-S	3,300	2 / 5 / 10	7.90	15	25	100	3.40	290	Orange	Orange	Red
LCN1008T-3R9□-S	3,900	2 / 5 / 10	7.90	15	25	100	3.60	260	Orange	White	Red
LCN1008T-4R7□-S	4,700	2 / 5 / 10	7.90	13	25	90	4.00	260	Yellow	Violet	Red
LCN1008T-5R6□-S	5,600	2 / 5 / 10	7.90	16	7.9	20	4.00	240	Green	Yellow	Red
LCN1008T-6R8□-S	6,800	2 / 5 / 10	7.90	18	7.9	40	4.90	200	Yellow	Gray	Red
LCN1008T-8R2□-S	8,200	2 / 5 / 10	7.90	18	7.9	25	6.00	170	Gray	Red	Red

Note:  
 When ordering, please specify tolerance and packaging codes.  
 Tolerance: G = ± 2%, J = ± 5%, K = ± 10%  
 Packaging: Clear tape and reel (standard)  
 Test Instruments: L/Q- Agilent/HP4291A+Agilent/HP16197A  
 SRF- HP8753D/HP4291A  
 RDC- CH502BC/HP4338B  
 I<sub>rms</sub>- For a 15 °C rise above 25 °C ambient.  
 Operating Temperature Range: -40 °C to +125 °C

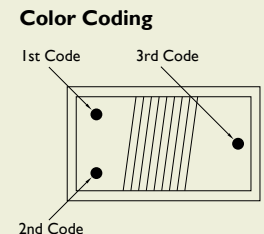



## ELECTRICAL CHARACTERISTICS LCN1206

PART NO.	INDUCTANCE (nH)	TOLERANCE (±%)	TEST FREQUENCY (MHz)	Q Min.	TEST FREQUENCY (MHz)	SRF (MHz) Min.	DC RESISTANCE (Ω) Max.	I <sub>rms</sub> (mA) Max.	COLOR CODING		
									1 <sup>st</sup>	2 <sup>nd</sup>	3 <sup>rd</sup>
LCN1206T-3N3□-S	3.3	5 / 10	100	30	300	6,200	0.05	1,000	Black	Orange	Black
LCN1206T-6N8□-S	6.8	5 / 10	100	30	300	5,500	0.07	1,000	Black	Blue	Black
LCN1206T-10N□-S	10	2 / 5 / 10	100	40	300	4,000	0.08	1,000	Brown	Black	Black
LCN1206T-12N□-S	12	2 / 5 / 10	100	40	300	3,200	0.08	1,000	Brown	Red	Black
LCN1206T-15N□-S	15	2 / 5 / 10	100	40	300	3,200	0.10	1,000	Brown	Green	Black
LCN1206T-18N□-S	18	2 / 5 / 10	100	50	300	2,800	0.10	1,000	Brown	Gray	Black
LCN1206T-22N□-S	22	2 / 5 / 10	100	50	300	2,200	0.10	1,000	Red	Red	Black
LCN1206T-27N□-S	27	2 / 5 / 10	100	50	300	1,800	0.11	1,000	Red	Violet	Black
LCN1206T-33N□-S	33	2 / 5 / 10	100	55	300	1,800	0.11	1,000	Orange	Orange	Black
LCN1206T-39N□-S	39	2 / 5 / 10	100	55	300	1,800	0.12	1,000	Orange	White	Black
LCN1206T-47N□-S	47	2 / 5 / 10	100	55	300	1,500	0.13	1,000	Yellow	Violet	Black
LCN1206T-56N□-S	56	2 / 5 / 10	100	55	300	1,450	0.14	1,000	Green	Blue	Black
LCN1206T-68N□-S	68	2 / 5 / 10	100	55	300	1,200	0.26	900	Blue	Gray	Black
LCN1206T-82N□-S	82	2 / 5 / 10	100	55	300	1,200	0.21	900	Gray	Red	Black
LCN1206T-R10□-S	100	2 / 5 / 10	100	55	300	1,100	0.26	850	Brown	Black	Brown
LCN1206T-R12□-S	120	2 / 5 / 10	100	60	300	1,100	0.26	800	Brown	Red	Brown
LCN1206T-R15□-S	150	2 / 5 / 10	100	60	300	950	0.31	750	Brown	Green	Brown
LCN1206T-R18□-S	180	2 / 5 / 10	50	60	300	900	0.43	700	Brown	Gray	Brown
LCN1206T-R22□-S	220	2 / 5 / 10	50	60	300	760	0.50	670	Red	Red	Brown
LCN1206T-R27□-S	270	2 / 5 / 10	50	55	300	730	0.56	630	Red	Violet	Brown
LCN1206T-R33□-S	330	2 / 5 / 10	50	45	150	650	0.62	590	Orange	Orange	Brown
LCN1206T-R39□-S	390	2 / 5 / 10	50	45	150	600	0.75	530	Orange	White	Brown
LCN1206T-R47□-S	470	2 / 5 / 10	50	45	150	550	1.30	490	Yellow	Violet	Brown
LCN1206T-R56□-S	560	2 / 5 / 10	35	45	150	470	1.34	460	Green	Blue	Brown
LCN1206T-R62□-S	620	2 / 5 / 10	35	45	150	470	1.58	460	Blue	Red	Brown
LCN1206T-R68□-S	680	2 / 5 / 10	35	45	150	450	1.58	430	Blue	Gray	Brown
LCN1206T-R75□-S	750	2 / 5 / 10	35	45	150	440	2.25	320	Violet	Green	Brown
LCN1206T-R82□-S	820	2 / 5 / 10	35	45	150	420	1.82	400	Gray	Red	Brown
LCN1206T-R91□-S	910	2 / 5 / 10	35	45	150	410	2.95	310	White	Brown	Brown
LCN1206T-1R0□-S	1,000	2 / 5 / 10	35	45	150	400	2.80	320	Brown	Black	Red
LCN1206T-1R2□-S	1,200	2 / 5 / 10	35	45	150	380	3.20	300	Brown	Red	Red

### Note:

When ordering, please specify tolerance and packaging codes.

Tolerance: G = ± 2%, J = ± 5%, K = ± 10%

Packaging: Clear tape and reel (standard)

Test Instruments: L/Q- Agilent/HP4291A+Agilent/HPI 6197A

SRF- HP8753D/HP4291A

RDC- CH502BC/HP4338B

I<sub>rms</sub>- For a 15 °C rise above 25 °C ambient.

Operating Temperature Range: -40 °C to +125 °C

### Color Coding

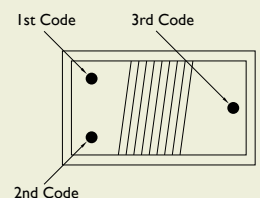

## TAPE DIMENSIONS

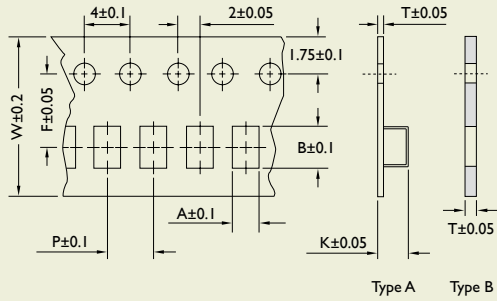

## TAPE MATERIAL

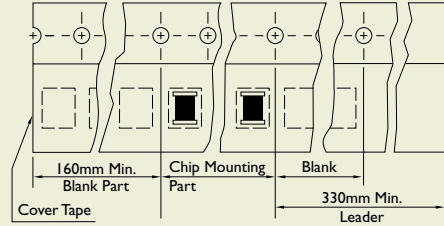

## REEL DIMENSIONS

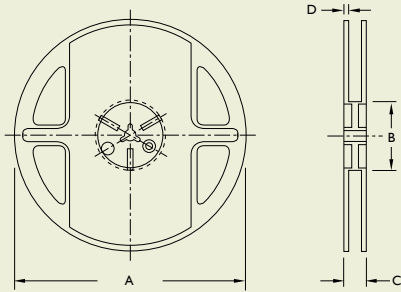

## RECOMMENDED PATTERN

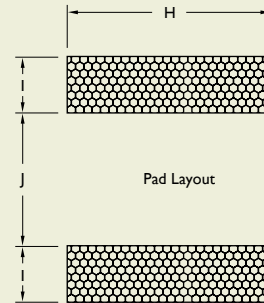

Dimensions: mm

TYPE	TAPE DIMENSIONS								TAPE TYPE	RECOMMENDED PATTERN			REEL DIMENSIONS				QUANTITY/ REEL
	A	B	T	W	P	F	K	UNIT		H	I	J	A	B	C	D	
LCN0603	1.23	1.90	0.97	8	4	3.50	-	B	inch	0.040	0.025	0.025	178	60	12	1.5	4,000
									mm	1.02	0.64	0.64					
LCN0805	1.85	2.45	0.23	8	4	3.50	1.45	A	inch	0.070	0.040	0.030	178	60	12	1.5	2,500
									mm	1.78	1.02	0.76					
LCN1008	2.80	2.95	0.23	8	4	3.50	2.20	A	inch	0.100	0.040	0.050	178	60	12	1.5	2,000
									mm	2.54	1.02	1.27					
LCN1206	2.95	3.85	0.25	12	4	5.50	2.45	A	inch	0.106	0.039	0.079	178	60	16	1.4	2,000
									mm	2.70	1.00	2.00					