

Total solder points: 224

Difficulty level: *beginner* 1  2  3  4  5  *advanced*

## Two channel codelock receiver



# K6727

Operate lighting, arm alarm systems,  
open carports, etc ... from a comfortable  
distance.

### Features:

- ☑ Easy to build: no coils to be made!
- ☑ Works together with the K6706/K6706A two channel transmitter.
- ☑ For operating garage door.
- ☑ Operating outdoor or indoor lights.
- ☑ Remote control of electrical door locks.
- ☑ Remote control of pool lights or fountain...
- ☑ Two power relays included.
- ☑ Each output selectable for toggle or pulse contact.
- ☑ It is possible to put two receivers in cascade at same location, for four channel output (in combination with two transmitters).

### Specifications:

- Two code channels.
- 8.748 possible codes.
- On / off LED indication for each channel.
- Two 10A relay outputs.
- Dimensions: 85 x 85mm
- Power supply: 2x9VAC or 12 to 16VDC / 120mA

\* modifications reserved.



NOT SUITED TO OPERATE MACHINES OR OTHER  
EQUIPMENT THAT COULD CAUSE INJURIES.

### 1. Assembly (Skipping this can lead to troubles !)

Ok, so we have your attention. These hints will help you to make this project successful. Read them carefully.

#### 1.1 Make sure you have the right tools:

- A good quality soldering iron (25-40W) with a small tip.
- Wipe it often on a wet sponge or cloth, to keep it clean; then apply solder to the tip, to give it a wet look. This is called 'thinning' and will protect the tip, and enables you to make good connections. When solder rolls off the tip, it needs cleaning.
- Thin raisin-core solder. Do not use any flux or grease.
- A diagonal cutter to trim excess wires. To avoid injury when cutting excess leads, hold the lead so they cannot fly towards the eyes.
- Needle nose pliers, for bending leads, or to hold components in place.
- Small blade and Phillips screwdrivers. A basic range is fine.

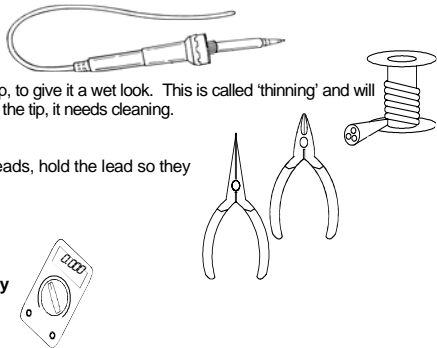

**For some projects, a basic multi-meter is required, or might be handy**

#### 1.2 Assembly Hints :

- ⇒ Make sure the skill level matches your experience, to avoid disappointments.
- ⇒ Follow the instructions carefully. Read and understand the entire step before you perform each operation.
- ⇒ Perform the assembly in the correct order as stated in this manual
- ⇒ Position all parts on the PCB (Printed Circuit Board) as shown on the drawings.
- ⇒ Values on the circuit diagram are subject to changes.
- ⇒ Values in this assembly guide are correct\*
- ⇒ Use the check-boxes to mark your progress.
- ⇒ Please read the included information on safety and customer service

\* Typographical inaccuracies excluded. Always look for possible last minute manual updates, indicated as 'NOTE' on a separate leaflet.

### 1.3 Soldering Hints :

1- Mount the component against the PCB surface and carefully solder the leads

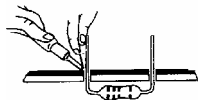

2- Make sure the solder joints are cone-shaped and shiny

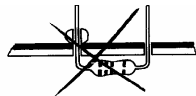
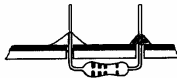

3- Trim excess leads as close as possible to the solder joint

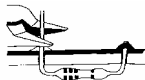

**REMOVE THEM FROM THE TAPE ONE AT A TIME !**

**AXIAL COMPONENTS ARE TAPED IN THE CORRECT MOUNTING SEQUENCE !**

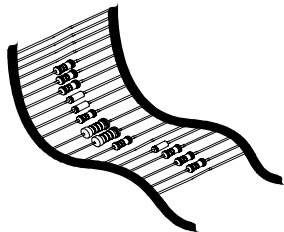

Velleman hereby certifies that the device K6727 meets the essential requirements and all other relevant stipulations of directive 1999/5/EG and 1995/5/EC.

For the complete conformity declaration check out : [http://www.velleman.be/downloads/doC/CE\\_K6727.pdf](http://www.velleman.be/downloads/doC/CE_K6727.pdf)

### 1. Jumper wires

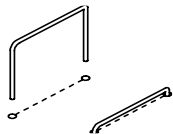

- J1
- J2

### 2. Diodes.

Watch the polarity !

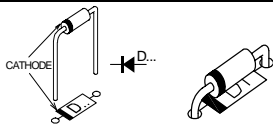

- D1 : 1N4148
- D2 : 1N4148
- D3 : 1N4148
- D4 : **1N4007**
- D5 : **1N4007**

### 3. Zener diodes

Watch the polarity !

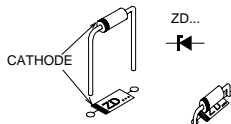

- ZD1 : 4V3
- ZD2 : 4V7 (5V1)

### 4. SAW resonator.

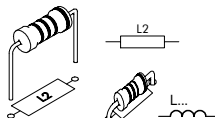

- L1 : 1 $\mu$ H (1-0-B)

### 5. Resistors

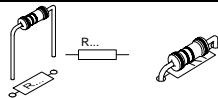

- R1 : 270 (2-7-1-B)
- R2 : 18K (1-8-3-B)
- R3 : 18K (1-8-3-B)
- R4 : 33K (3-3-3-B)
- R5 : 5K6 (5-6-2-B)
- R6 : 2K7 (2-7-2-B)
- R7 : 6K8 (6-8-2-B)
- R8 : 6M8 (6-8-5-B)
- R9 : 1K (1-0-2-B)
- R10 : 1K (1-0-2-B)
- R11 : 100K (1-0-4-B)
- R12 : 100K (1-0-4-B)
- R13 : 100K (1-0-4-B)
- R14 : 100K (1-0-4-B)
- R15 : 10K (1-0-3-B)
- R16 : 10K (1-0-3-B)
- R17 : 10K (1-0-3-B)
- R18 : 10K (1-0-3-B)
- R19 : 10K (1-0-3-B)
- R20 : 2K2 (2-2-2-B)
- R21 : 2K2 (2-2-2-B)
- R22 : 2k2 (2-2-2-B)

## 6. IC sockets. (check the position of the notch)

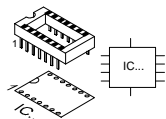

- IC1 : 18p
- IC2 : 18p
- IC3 : 8p
- IC4 : 14p

## 7. Capacitive trimmer

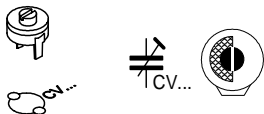

- CV1 : 5pF
- Set the tuning capacitor to around the middle of its adjustment range.

## 8. Capacitors

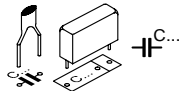

- C1 : 1p
- C2 : 2p (2p2)
- C3 : 22p
- C4 : 82p
- C5 : 330p (331)
- C6 : 330p (331)
- C7 : 330p (331)
- C8 : 330p (331)
- C9 : 100n (104)
- C10 : 100n (104)
- C11 : 100n (104)

## 9. Transistors

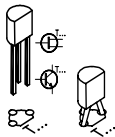

- T1 : BF199
- T2 : BC557B
- T3 : BC557B
- T4 : BC547B
- T5 : BC547B

## 10. LED's. Watch the polarity!

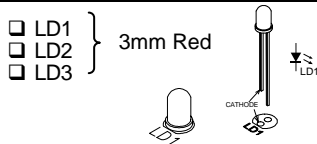

## 11. Screw connectors

First slide the connectors together one by one.



- SK1 : 3p
- SK2 : 3p
- SK3 : 3p

## 12. Capacitors. Watch the polarity !

- C12: 1 $\mu$
- C13: 1 $\mu$
- C14: 470 $\mu$

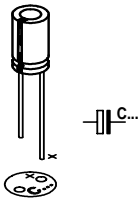

## 13. Voltage regula-

Mind the orientation !

- VR1 : 7809

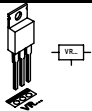

## 14. Relays

- RY1 : VR15
- RY2 : VR15

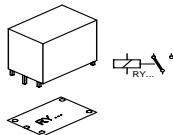

## 15. ICs. (check the position of the notch)

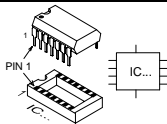

- IC1: UM3758-120A
- IC2: UM3758-120A
- IC3: RV4558 - LM258 - 2904
- IC4: CD4013

## 16. Sticker

Affix the supplied sticker to the housing.



## 17. Create your code

You can select your own code for a transmitter/receiver combination. There is a 9 row jumper island located directly next to IC1 for setting the code. The code is set by connecting one or more code points to a neighboring '+' or '-' point using the small jumpers. Code points may also be left unconnected (open): see figure.

a) No connection

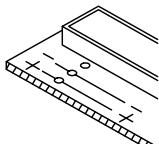

c) Code connection to '+'

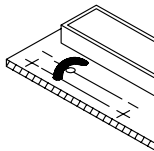

b) Code connection to '-'

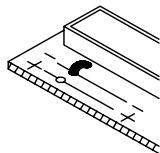

c) Example of a possible code

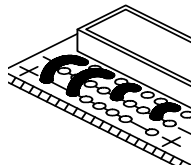

**Note:** certain points cannot be connected to '+'



## 18. Operating mode

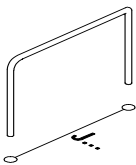

By using the jumpers JM1 or JT1, channel 1 of the receiver can be set up for two output possibilities:

1. Output channel 1 is on while the transmitter is pressed (MOMENT), this is mostly used for operating a door lock, garage door, etc.  
 JM1
2. Output channel 1 switches (on/off) every time the transmitter is pressed (TOGGLE), this setting is mostly used for switching alarms in and out, for operating central door locking systems, for switching a lamp on and off, etc.  
 JT1

***By using the jumpers JM2 or JT2, channel 2 from the receiver can be set up for two output possibilities:***

1. Output channel 2 is on while the transmitter is pressed (MOMENT).  
 JM2
2. Output channel 2 switches (on/off) every time the transmitter is pressed (TOGGLE).  
 JT2

## 19. Test and set-up

### **IMPORTANT:**

- For adjusting the receiver, a completely plastic tuning screwdriver (including plastic blade) is needed. This is supplied with the receiver.
- The transmitter must be in its housing with the cover on, and fitted with a new battery type V23GA or GP23A. Check the polarity which is shown in the housing.
- The receiver may not be in the vicinity of any metal objects.
- The transmitter and receiver must have the same code.

### **1) Use of the new K6706A transmitter:**

- Set the tuning capacitor CV1 of the receiver to around the middle of its adjustment range (see fig. 7). Check that the tuning LED of the receiver is not lit up, or is just on the verge of lighting up. If not, the tuning capacitor will have to be adjusted a little. Do not touch the circuit with your hand.
- Activate the transmitter and very carefully turn the tuning capacitor CV1 on the receiver until the tuning LED lights up. If all is well, one of the relays should now switch, if of course the codes of the transmitter and receiver are the same.
- For more precise tuning, get someone else to activate the transmitter from a few meters away and then fine-tune the receiver.
- Once the receiver has been set to a transmitter, then it will also be set for other transmitters of the K6706A type.

### **2) Use of the old K6706 transmitter:**

- Remove capacitor C1 from the transmitter.
- Set the tuning capacitor CV1 of the receiver to around the middle of its adjustment range (see fig. 7). Check that the tuning LED of the receiver is not lit up, or is just on the verge of lighting up. If not, the tuning capacitor will have to be adjusted a little. Do not touch the circuit with your hand.

- The transmitter must be in its housing with the cover off.
- Activate the transmitter (do not touch any other parts other than the push button) and then very carefully turn the tuning capacitor CV on the transmitter until the tuning LED of the receiver lights up. If all is well, one of the relays should now switch, if of course the codes of the transmitter and receiver are the same.
- For more precise tuning, activate the transmitter from a few meters away and then fine-tune the transmitter.

If the transmitter cannot be tuned to the receiver, then it might be that the tuning capacitor of the receiver needs to be adjusted.

### **3) Use of a new K6706A transmitter together with an old K6706 transmitter:**

- Do the receiver set-up and adjustment as in point 1 together with the new transmitter type K6706A.
- When using the old K6706 transmitter type, capacitor C1 of the transmitter must be removed.
- The transmitter must be in its housing with the cover off.
- Activate the transmitter (do not touch any other parts other than the push button) and then very carefully turn the tuning capacitor CV on the transmitter until the tuning LED of the receiver lights up. If all is well, one of the relays should now switch, if of course the codes of the transmitter and receiver are the same.
- For more precise tuning, activate the transmitter from a few meters away and then fine-tune the transmitter.

**REMARK:** When a new receiver K6727 is used in conjunction with a one channel receiver K6707, then on the K6707 capacitor C1 must be a 1pF type.

## 20. Connection

DC supply:

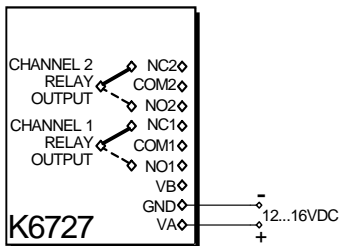

AC supply:

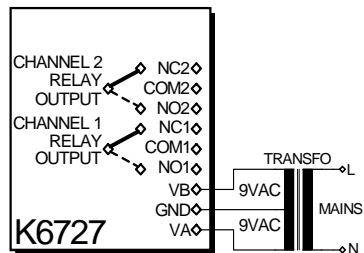

Other connections:

When using the relay output there is a choice between a normally closed contact (NC) or a normally open contact (NO). The common output is at COM.

## 21. Using 2 receivers at the same place

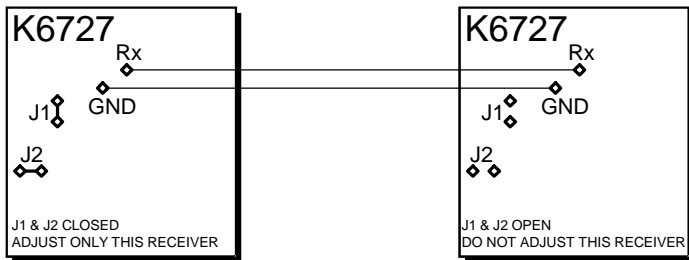

From one receiver, the jumpers J1 and J2 must be cut, this receiver must not be adjusted with the transmitter.

## 22. About the housing

The circuit can also be installed in a plastic housing (NOT A METAL BOX) e.g. WCAH2851. Place the housing in a place where there are few metal parts. It may be the case that after installation, the circuit will have to be retuned. This is because of the influence of metal parts in the vicinity of the circuit.

## 23. PCB layout.

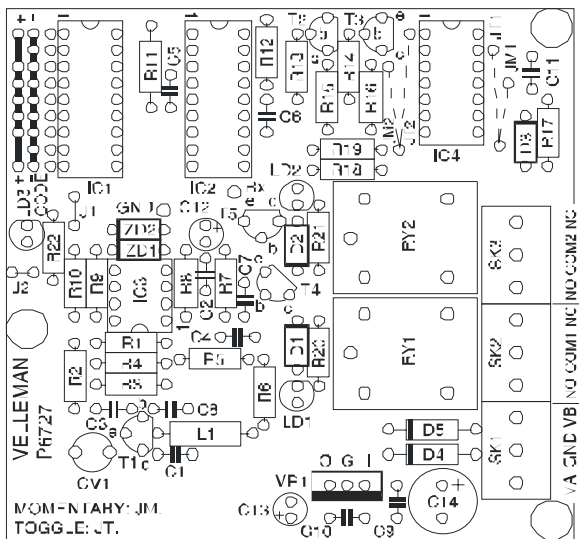

24. Diagram

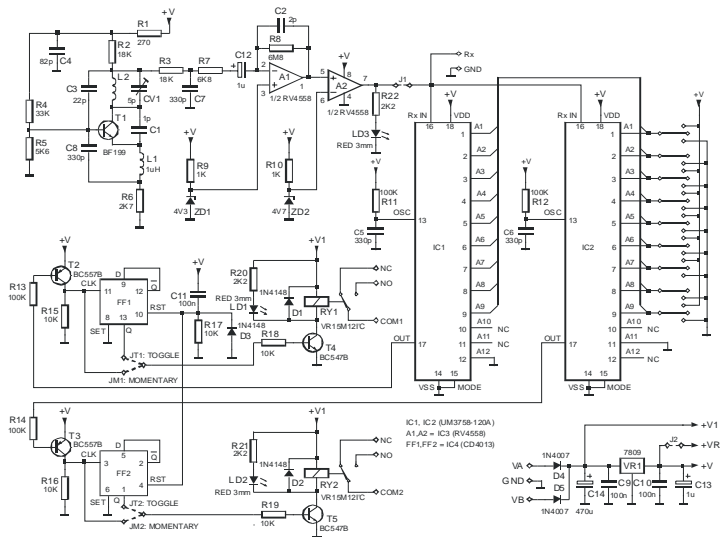



Modifications and typographical errors reserved  
© Velleman Components nv.  
H67271P - 2004 - ED2

