



**PCB terminal block; 2.5 mm<sup>2</sup>; Pin spacing 5/5.08 mm; 5-pole; CAGE CLAMP®; commoning option**

Item No.: 236-405



PCB terminal block; 2.5 mm<sup>2</sup>; Pin spacing 5/5.08 mm; 5-pole; CAGE CLAMP®; commoning option

**Marking**

RoHS ✓  
Compliant

**Business data**

Supplier	WAGO
Item no.	236-405
GTIN / EAN	4044918769495
Content	1
Order amount	45
Customer item number	

**Notes**

*Item description: Terminal strips with CAGE CLAMP® connection, screwdriver actuation parallel or perpendicular to conductor entry Also available with Ex e approval For custom terminal strip assemblies Operating tools for factory wiring 45° connection angle permits a wide range of uses and wiring options Set to metric or inch pin spacing by compressing terminal strips together or pulling them apart*

**Technical data**

*Miscellaneous*

No. of poles	5
Pin spacing	5/5.08 mm / 0.197/0.2 in

<b>Technical data</b>	
Total number of connection points	5
Total number of potentials	5
Color	gray
Ratings per	IEC/EN 60664-1
Rated voltage (III / 3) [V]	250 [V]
Rated impulse voltage (III / 3) [kV]	4 [kV]
Rated voltage (III/2) [V]	320 [V]
Rated impulse voltage (III / 2) [kV]	4 [kV]
Rated voltage (II / 2) [V]	630 [V]
Rated impulse voltage (II / 2) [kV]	4 [kV]
Rated current [A]	24 [A]
Number of connection objects	1
Number of levels	1
Connection technology	CAGE CLAMP®
Number of connection points connector	1
Actuation type	Operating tool
Solid conductors, tool-operated termination	0.08 ... 2.5 mm <sup>2</sup> / 28 ... 12 AWG
Fine-stranded conductors, tool-operated termination	0.08 ... 2.5 mm <sup>2</sup> / 28 ... 12 AWG
Fine-stranded conductors with insulated ferrule	0.25 ... 1.5 mm <sup>2</sup> / ...
Fine-stranded conductors with uninsulated ferrule	0.25 ... 1.5 mm <sup>2</sup> / ...
Strip length	5 ... 6 mm / 0.2 ... 0.24 inch
Conductor entry angle to the PCB [°]	45 [°]
Cross section up to (1) [mm <sup>2</sup> ]	2.5 [mm <sup>2</sup> ]
Cross section from (1) [AWG]	28 [AWG]
Cross section from (2) [mm <sup>2</sup> ]	0.08 [mm <sup>2</sup> ]
Cross section up to (2) [mm <sup>2</sup> ]	2.5 [mm <sup>2</sup> ]
Solder pin arrangement	in line
Solder pin length [mm]	4 [mm]
Drilled hole diameter (tolerance) [mm]	1.1(+ 0.1) [mm]
Drilled hole diameter [mm] [mm]	1.1 [mm]
Tolerance of drilled hole diameter plus [mm] [mm]	+0.1 [mm]
Material group	I
Insulating material	Polyamide 66 (PA 66)
Flammability class per UL94	V0

<b>Technical data</b>	
<i>Limit temperature range</i>	<i>-60 ... 105 C</i>
<i>Clamping spring material</i>	<i>Chrome-nickel spring steel (CrNi)</i>
<i>Contact material</i>	<i>Electrolytic copper (Ecu)</i>
<i>Contact plating</i>	<i>tin-plated</i>
<i>Fire load [MJ]</i>	<i>0.064 [MJ]</i>
<i>Weight [g]</i>	<i>4.44 [g]</i>
<i>Width</i>	<i>27.3 mm / 1.075 in.</i>
<i>Height</i>	<i>17 mm / 0.669 in.</i>
<i>Height from the surface</i>	<i>13 mm / 0.512 in.</i>
<i>Depth</i>	<i>14 mm / 0.551 in.</i>
<i>Pin spacing up to [in]</i>	<i>0.2 [in]</i>

Images & drawings

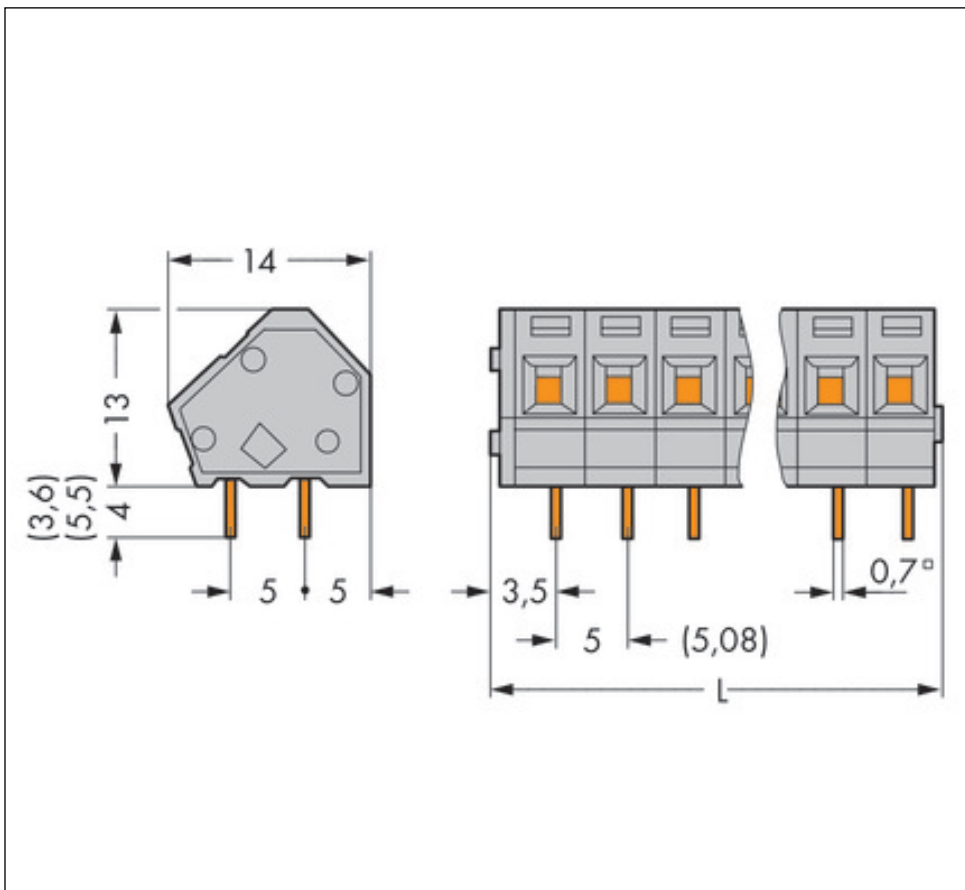
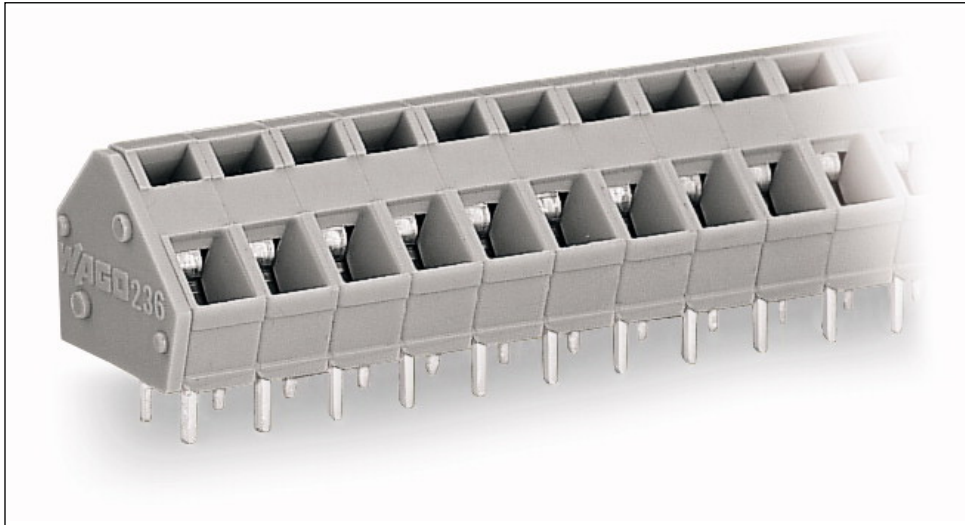

**Address**

WAGO Kontakttechnik GmbH & Co. KG

Hansastr. 27

32423 Minden

Telefon: 0571/887-0

Fax: 0571/887-169

<http://www.wago.com>

© WAGO Kontakttechnik GmbH & Co. KG

Technische Änderungen und Irrtümer vorbehalten.