

Capacitors for Use in Electronics

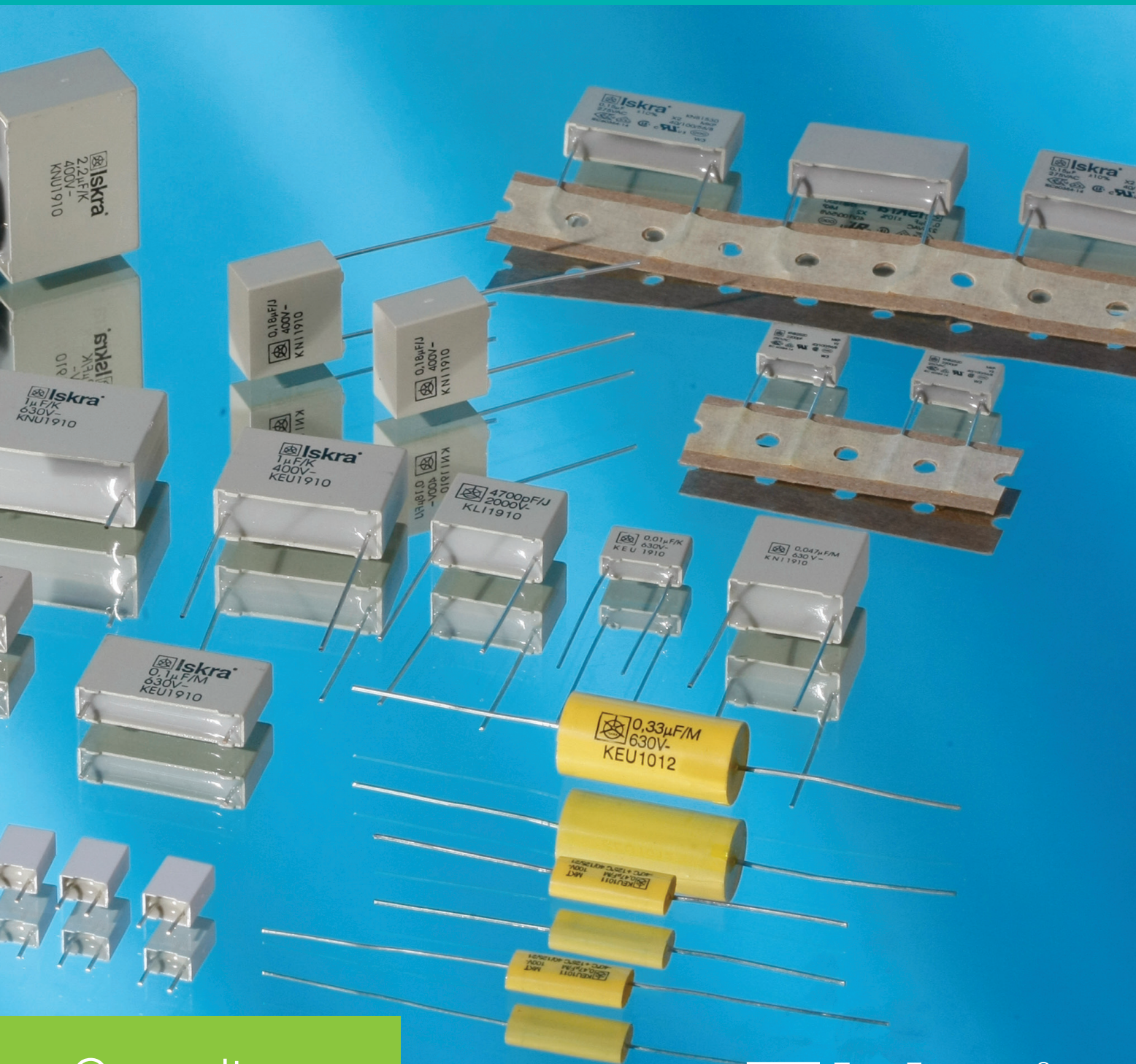

Capacitors







Contents

General information on Iskra Capacitors for use in electronics

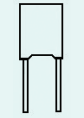
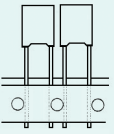
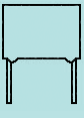
Type	Construction of capacitors	Class	Page
KFU	polyester capacitors	(KT)	13
KEU	metallized polyester capacitors	(MKT)	16
KLI	polypropylene capacitors	(KP)	24
KNI	metallized polypropylene capacitors	(MKP)	29
KNU	metallized polypropylene capacitors	(MKP)	36

Contents

Type	Version	Pitch (mm)	Dielectric	Capacitance range	Rated voltage	Page
KFU1910		10; 15; 22,5; 27,5	Polyester film (KT)	0,022 μ F — 1 μ F 0,015 μ F — 0,47 μ F 4700 pF — 0,33 μ F 1000 pF — 0,22 μ F 1000 pF — 0,068 μ F	100 V DC 250 V DC 400 V DC 630 V DC 1000 V DC	14
KEU1930		7,5	Metallized polyester film (MKT)	0,068 μ F — 1 μ F 0,033 μ F — 0,33 μ F 0,01 μ F — 0,15 μ F 4700 pF — 0,033 μ F 1000 pF — 0,015 μ F	63 V DC 100 V DC 250 V DC 400 V DC 630 V DC	17
KEU1930 taped						
KEU1910		10; 15; 22,5; 27,5	Metallized polyester film (MKT)	0,22 μ F — 22 μ F 0,068 μ F — 10 μ F 0,033 μ F — 10 μ F 0,01 μ F — 4,7 μ F 4700 pF — 1,5 μ F 1000 pF — 0,68 μ F	63 V DC 100 V DC 250 V DC 400 V DC 630 V DC 1000 V DC	19
KEU1012		axial leads	Metallized polyester film (MKT)	0,15 μ F — 10 μ F 0,068 μ F — 10 μ F 0,047 μ F — 10 μ F 0,01 μ F — 3,3 μ F 1000 pF — 1 μ F 1000 pF — 0,47 μ F	63 V DC 100 V DC 250 V DC 400 V DC 630 V DC 1000 V DC	22
KLI1910	 PULSE	7,5;10; 15; 22,5; 27,5	Polypropylene film (KP)	6800 pF — 0,15 μ F 3300 pF — 0,1 μ F 2200 pF — 0,047 μ F 1000 pF — 0,047 μ F 100 pF — 0,22 μ F 1000 pF — 0,22 μ F 1000 pF — 0,1 μ F 1000 pF — 0,047 μ F	100 V DC 160 V DC 250 V DC 400 V DC 630V DC 1000 V DC 1600 V DC 2000 V DC	25
KNI1910	 PULSE	7,5; 10; 15; 22,5	Metallized polypropylene film (MKP)	680 pF — 2,2 μ F 680 pF — 1,8 μ F 680 pF — 0,39 μ F 3300 pF — 0,33 μ F 1000 pF — 0,15 μ F 1000 pF — 0,1 μ F	250 V DC 400 V DC 630 V DC 1000 V DC 1600 V DC 2000 V DC	30
KNU1910		10; 15; 22,5; 27,5	Metallized polypropylene film (MKP)	0,022 μ F — 6,8 μ F 0,01 μ F — 2,2 μ F 4700 pF — 1 μ F 0,01 μ F — 1 μ F 1000 pF — 0,33 μ F	250 V DC 400 V DC 630 V DC 1000 V DC 1600 V DC	37

General technical data

ISKRA capacitors for use in electronics are made of dielectric materials as follow:

- polypropylene film
- polyester (polyethyleneterephthalate).

Survey of specific properties of individual dielectrics and use:

Polyester (polyethyleneterephthalate) film

Dielectric constant (25 °C/1 kHz):

$\epsilon_r = 3,25$; ASTM D 150-65T

Dielectric loss (25 °C/60 Hz):

$\tan\delta \leq 20,10^{-4}$ C;
ASTM D 150-65T

Dielectric strength (25 °C/60 Hz):

295 kV/mm; ASTM D 149-64,
ASTM D 2305-67

Temperature coefficient of capacitance:

$TC \approx + 500, 10^{-6}$ C/°C

Temperature range max.:

+ 125 °C

Water absorption (sink for 24 h):

0,8 % max.; ASTM D 570-63

Dielectric absorption:

0,2 to 0,8 %

Polyester capacitors are used mainly in electronic devices where special characteristics of electrical parameters are not required and where wider temperature range is required. Mainly they are used as conjunctive or block capacitors.

Polypropylene film

Dielectric constant (25 °C/1 kHz):

$\epsilon_r = 2,2$; ASTM D 150

Dielectric loss (25 °C/1 kHz):

$\tan\delta \leq 5,10^{-4}$ C; ASTM D 150

Dielectric strength (25 °C/1 kHz):

300 to 380 kV/mm; ASTM D 149

Temperature coefficient of capacitance:

$(- 100 \leq TC \leq -300), 10^{-6}$ /°C

Temperature range max.:

+ 100 °C

Water absorption:

< 0,05 %; ASTM D 202

Dielectric absorption:

0,03 %

Polypropylene capacitors are used mainly in electronic circuits, where following requirements appear:

- small dielectric losses
- high insulation resistance
- negative and defined temperature coefficient (temperature compensation at oscillating circles with ferrite coil)
- high pulse loading
- loading with AC voltage.

Designation of dielectric in type code of capacitors

Type code is composed by three letters and four figures:

K	X	X		Y	Y	Y	Y
↓	↓	↓		↓	↓	↓	↓
1	2	3		4	5	6	7

1st Letter, "K" means capacitor

2nd Letter tells the type of dielectric (special for metallized version)

3rd Letter tells the purpose of use

4th, 5th, 6th, 7th Figure describes construction and design of capacitor and leads

Survey of letter used for single kinds of dielectric:

F - polyester film

E - metallized polyester film

L - polypropylene film

N - metallized polypropylene film

Electrical characteristics

1. Rated capacitance

Rated capacitance C_R values are available according to E-ranges. Available E-ranges (E6, E12, E24, E48, E96, on request E192) are stated at type descriptions in catalogue. The values from range E6 are privileged.

The E-ranges are put down in accordance to IEC-publ. 60063 and DIN 41426.

Required values from E-range are all values from table below, multiplied by positive or negative whole number power exponent of the number 10.

E6 ± 20 %	E12 ± 10 %	E24 ± 5 %	E48 ± 2 %	E96 ± 1 %	E192 ± 0,5 %	
100	100	100	100	100	100	
				101	102	
				102	104	
			105	105	105	
				106	107	
				107	109	
		110	110	110	110	
				111	113	
				113	114	
			115	115	115	
				117	118	
				118	120	
		120	120	121	121	121
					123	124
					124	126
	127			127	127	
				129	130	
				130	132	
	130		133	133	133	
				135	137	
				137	138	
			140	140	140	
				142	143	
				143	145	

E6 ± 20 %	E12 ± 10 %	E24 ± 5 %	E48 ± 2 %	E96 ± 1 %	E192 ± 0,5 %	
150	150	150	147	147	147	
				149	150	
				150	152	
			154	154	154	
				156	158	
				158	160	
		160	162	162	162	
				164	165	
				165	167	
			169	169	169	
				172	174	
				174	176	
		180	180	178	178	178
					180	182
					182	184
	187			187	187	
				189	191	
				191	193	
	200		196	196	196	
				198	200	
				200	203	
			205	205	205	
				208	210	
				210	213	

E6 ± 20 %	E12 ± 10 %	E24 ± 5 %	E48 ± 2 %	E96 ± 1 %	E192 ± 0,5 %	
220	220	220	215	215	215	
				218	221	
				221	223	
			226	226	226	
				229	232	
				232	234	
		237	237	237	237	
				240	243	
				243	246	
			249	249	249	
				252	255	
				255	258	
		270	270	261	261	261
					264	267
					267	271
	274			274	274	
				277	280	
				280	284	
	300		287	287	287	
				291	294	
				294	298	
			301	301	301	
				305	309	
				309	312	

E6 ± 20 %	E12 ± 10 %	E24 ± 5 %	E48 ± 2 %	E96 ± 1 %	E192 ± 0,5 %			
330	330	330	316	316	316			
				320	324			
				324	328			
				332	332	336		
					340	344		
					348	348	352	
			357			361		
			365			365	370	
						374	379	
				390		383	383	388
							392	397
					402		402	407
		412					417	
		422	422				427	
			432				437	
			442			442	448	
						453	459	

E6 ± 20 %	E12 ± 10 %	E24 ± 5 %	E48 ± 2 %	E96 ± 1 %	E192 ± 0,5 %			
470	470	470	464	464	464			
				470	475			
				475	481			
				487	487	493		
					499	505		
					511	511	517	
			523			530		
			536			536	542	
						549	556	
				560		562	562	569
							576	583
					590		590	597
		604					612	
		619	619				626	
			634				642	
			649			649	657	
						665	673	

E6 ± 20 %	E12 ± 10 %	E24 ± 5 %	E48 ± 2 %	E96 ± 1 %	E192 ± 0,5 %			
680	680	680	681	681	681			
				698	706			
				715	715	723		
					732	741		
					750	750	759	
						768	777	
			787			787	796	
						806	816	
				820		825	825	835
							845	856
					866		866	876
							887	898
		909	909				920	
			931				942	
			953			953	965	
						976	988	

2. Tolerance of rated capacitance

Standard tolerances and belonging codes for marking tolerances of rated capacitances are as follow:

Tolerance	± 20 %	± 10 %	± 5 %	(± 2,5 %)	± 2 %	(±1,25 %)	± 1 %	± 0,5 %
Code	M	K	J	(H)	G	(E)	F	D

The narrowest possible tolerance is ± 1 pF (Z).

Available tolerances of rated capacitances are stated at type descriptions in catalogue.

3. Temperature dependence of capacitance

Temperature coefficient TC is defined for temperature range $\vartheta_1 \dots \vartheta_2$ according to DIN 41380 as follows:

$$TC = \frac{C_2 - C_1}{C_3 (\vartheta_2 - \vartheta_1)}$$

C_1 - capacitance at temperature ϑ_1

C_2 - capacitance at temperature ϑ_2

C_3 - capacitance at temperature $(25 \pm 10)^\circ\text{C}$

Temperature coefficient for single type of capacitors is given in $10^{-6}/^\circ\text{C}$.

4. Rated voltage U_R

The rated voltage U_R is the maximum direct voltage which may be applied continuously to the terminals of a capacitor at any temperature between the lower category temperature and the rated temperature.

5. Category voltage U_C

Category voltage U_C is the maximum direct voltage which may be applied to the terminals of a capacitor at its upper category temperature. Adequate reducing of voltage for temperature range between upper rated temperature and category temperature is given at single types of capacitors in catalogue.

6. Alternating voltage loading

Allowed alternating voltage loading for single types is limited to frequency 50 to 60 Hz. The sum of applied alternating voltage (amplitude) and direct voltage to the terminals of a capacitor must not exceed category voltage U_C . In general mica and plastic foil capacitors are not suitable for connection to network, except special versions of capacitors, which are suitable also for such purposes.

7. Allowed self-heating because of alternating voltage loading

If capacitors are loaded with alternating voltages of higher frequencies with sinusoidal or unsinusoidal shape of alternating voltage, than self-heating and pulse loading is to consider.

Self heating of capacitor ($\Delta\vartheta$) is in operating of capacitor conditioned by belonging power loss (P_i) and outer surface of capacitor (S), and is calculated by the following from:

$$\Delta\vartheta(K) = \frac{P_i \text{ (mW)}}{S(\text{cm}^2) \beta}$$

where the base for thermoplastic case is used

$$\beta = 1 \left(\frac{\text{mW}}{\text{K} \cdot \text{cm}^2} \right)$$

Power loss of capacitor (P_i) at loading with sinusoidal voltage of higher frequencies is calculated as follows:

$$P_i = U_{\text{ef}}^2 \cdot 2 \pi \cdot f \cdot C \cdot \tan\delta(f)$$

where:

C = capacitance in F

U_{ef} = effective voltage in V

f = frequency in Hz

$\tan\delta(f)$ = loss factor at frequency f

P_i = power loss in W

At un-sinusoidal alternating voltage it is to be dismantled according to Fourier's analysis to sinusoidal voltages and calculated the power loss as a sum of single partial sinusoidal power losses. For carrying-out the Fourier's analysis the voltage-time diagram is needed.

The sum of temperatures because of self-heating and temperature of surroundings of capacitor may be equal or lower than permitted category temperature with considering the category voltage U_C .

8. Pulse loading

The capacitors charged with un-sinusoidal voltage pulses with quick rise (high du/dt) will be loaded with high current pulses. Because of overloading of internal contacts and connections in capacitor the current must be limited, The boundary current for single types of capacitors depend on:

- amplitude and shape of pulse
- rated voltage of capacitor
- capacitance
- geometrical shape of capacitor.

At the repeating pulses the current loading will be limited by self-heating, surrounding temperature and cooling.

The limit of allowed current loading is given with allowed voltage rise in time (du/dt) in $V/\mu\text{s}$ (volts per microsecond)

$$I_{\text{max}} = C_R \frac{du}{dt}$$

C_R = rated capacitance in μF
 du/dt = allowed pulse loading in $V/\mu\text{s}$

At single types of capacitors the data of allowed pulse loading is valuable for unlimited number of pulses (charging and discharging of capacitors) up to rated voltage U_R . Minimum resistance in series with capacitor is then:

$$R = \frac{U_R}{C_R \cdot du/dt}$$

where:

U_R = rated voltage of the capacitor in V

C_R = rated capacitance in μF

R = min. series resistance in Ohm

At the pulses of lower voltage than rated voltage the given values of allowed pulse loading are to multiply with the relation factor rated voltage/pulse voltage.

If the demanded pulse loading of the capacitor comply with the requests in certain case, the control is needed to be sure that power loss is not exceeded, resp. self-heating is in area of allowed pulse loading max. 15 °C. In critical cases the capacitor surface temperature is to measure and temperature fall of 5 °C inside capacitor is to consider.

9. Disipation factor $\tan\delta$

Every capacitor has beside desired capacitance also of her electrical properties, which are shown as constituent elements in following by connection:

L_S - serial inductance

R_S - serial resistnace

R_i - insulation resistance (parallel resistance)

C - capacitance

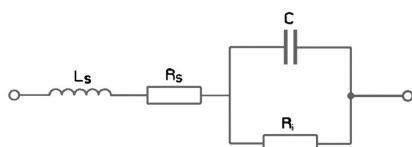

The real capacitor has always incorrectnesses as serial inductance L_S and loss resistance R_S and R_i . The inductance can be reduced but not to zero. At certain frequency f_0 the capacitance and inductance reactances are equal:

$$\frac{1}{\omega_0 C} = \omega_0 L$$

where

$$\omega_0 = 2\pi f_0$$

At frequencys higher than f_0 (the resonant frequency) the inductive component prevail. The resistance R_S is the resistance of the capacitor's wires, transitional resistance of electrode contacting, the resistance of capacitor electrodes and polarisation losses in capacitor dielectric. Resistance R_i is insulating resistance depending on insulating properties of dielectric in capacitor.

Values R_S and R_i determine losses in capacitor and depend on temperature, frequency, voltage and capacitance and cause heating of capacitor. The resistance R_i is much bigger then the resistance R_S so we can change both resistances only with equivalent serial resistance of capacitor ESR.

The relation between equivalent serial resistance of capacitor ESR and his reactance $1/\omega C$ is dissipation factor of capacitor and is marked with $\tan\delta$.

$$\tan\delta = ESR \cdot \omega \cdot C$$

The values of dissipation factor ($\tan\delta$) are given at single types of capacitors in catalogue.

10. Insulation resistance R_i

Insulation resistance of capacitor is given as resistance R_i in $M\Omega$ or as time constant in seconds $R_i \cdot C_R = M\Omega \cdot \mu F$.

The insulation resistance is the relation between the applied direct voltage and the current, after precise determined time. The limited values for insulation resistance are given for testing time 60 sec. at 20 °C.

Test voltages in accordance to rated voltages are as follow:

Rated voltage U_R	Test voltage
< 100 V	10 V
100 V $\leq U_R$ < 500 V	100 V
≥ 500 V	500 V

Lead spacing 7,5 mm

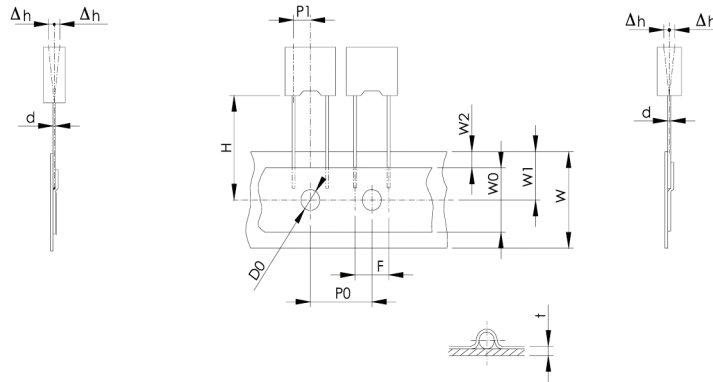

Descriptions	Symbol	Dimensions (mm)	
		Lead spacing 7,5 mm	Tolerances
Carrier tape width	W	18	+ 1/-0,5
Hold-down tape width	W ₀	12	± 0,5
Hotel position	W ₁	9	± 0,5
Hold-down tape position	W ₂	3 max.	
Feed hole diameter	D ₀	4	± 0,2
Pitch of component	P	12,7	± 1
Feed hole pitch	P ₀ *	12,7	± 0,3
Feed hole centre to lead	P ₁	3,75	± 0,7
Feed hole centre to component centre	P ₂	12,7	± 1,3
Height from feed hole centre to the component body	H	18,5	± 0,5
Component alignment	Δp	0	± 1,3
	Δh	0	± 2
Lead spacing	F	7,5	+ 0,6/-0,1
Lead wire diameter	d	0,6	± 0,5
Total tape thickness	t	0,7	± 0,2

* Cumulative pitch error over any 20 pitches: max. ± 1mm

Package units for radial taped film capacitors:

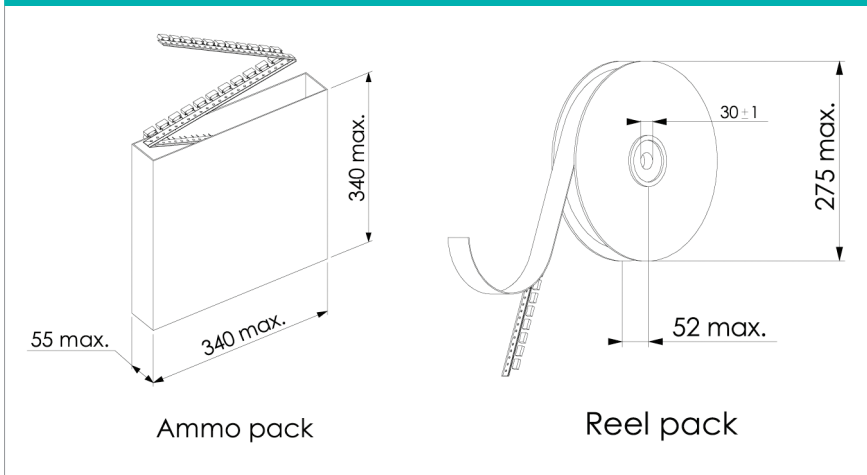

KEU1930 taped

Capacitor thickness b (mm)	Ammo-pack (pcs/box)	Reel-pack (pcs/reel)
3,5	2250	1000
4	1900	850
4,5	1700	750
5	1550	700
6	1300	600

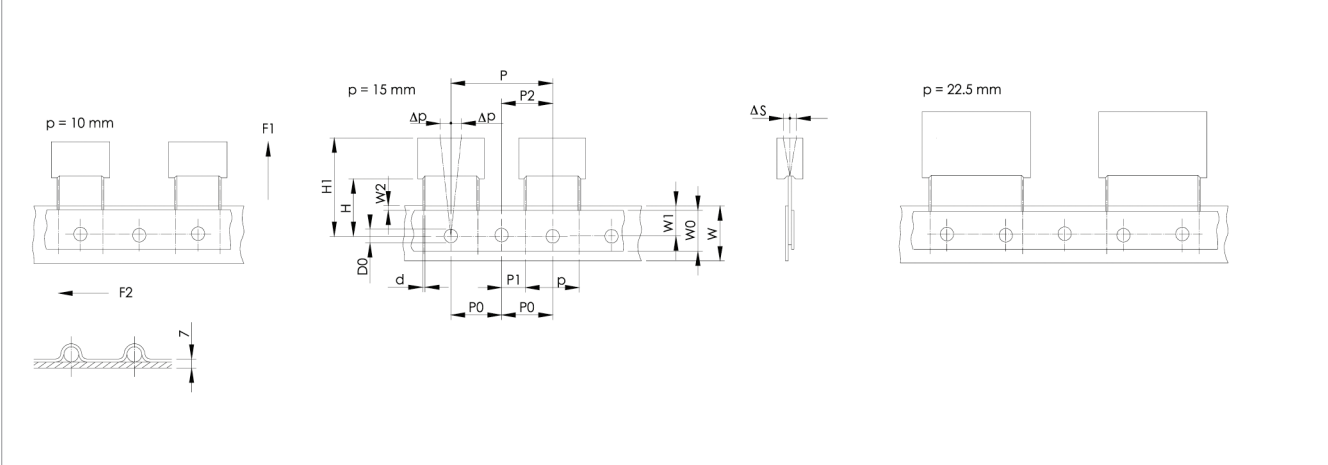

Descriptions	Symbol	Dimensions (mm)			Tolerances
		Lead spacing 10 mm	Lead spacing 15 mm	Lead spacing 22,5 mm	
Carrier tape width	W	18	18	18	+ 1/-0,5
Hold-down tape width	W ₀	12 or 6	12 or 6	12 or 6	± 0,5
Hotel position	W ₁	9	9	9	± 0,5
Hold-down tape position	W ₂	3	3	3	max
Feed hole diameter	D ₀	4	4	4	± 0,2
Pitch of component	P	25,4	25,4	38,1	± 1
Feed hole pitch	P ₀ *	12,7	12,7	12,7	± 0,2
Feed hole centre to lead	P ₁	7,7	5,2	7,8	± 0,7
Feed hole centre to component centre	P ₂	12,7	12,7	19,5	± 1,3
Height from feed hole centre to the component body	H	18,5	18,5	18,5	± 0,5
Component alignment	Δp	0	0	0	± 1,3
	ΔS	0	0	0	± 2
Lead spacing	p	10	15	22,5	+ 0,6/-0,1
Lead wire diameter	d	0,6	0,8	0,8	± 0,5
Total tape thickness	t	0,7	0,7	0,7	± 0,2
Extraction force for components	F ₁	5	5	5	min. (N)
Break force of the tape	F ₂	15	15	15	min. (N)
Component height	H ₁	31	34	39	max

* Cumulative pitch error over any 20 pitches: max. ±1mm

Package units for radial taped film capacitors:

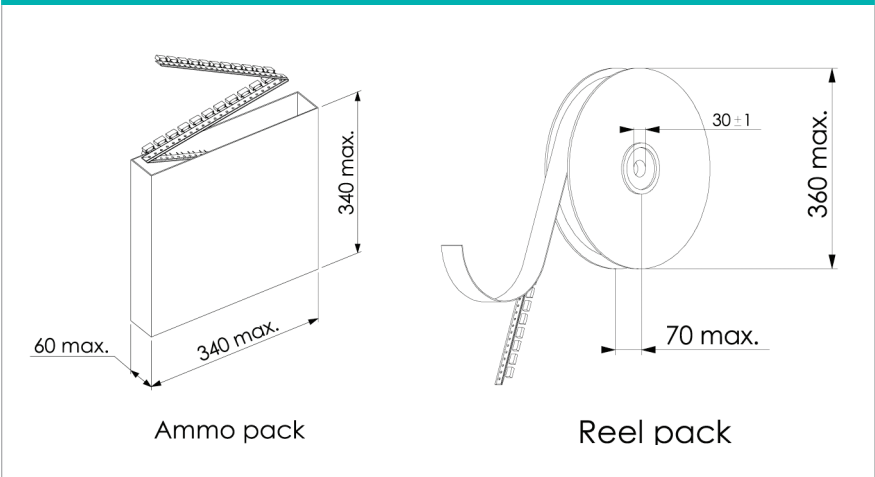

Taped package units

Pitch (mm)	Capacitor thickness b (mm)	Ammo-pack (pcs/box)	Reel-pack (pcs/reel)
10	4; 4,3	900	900
	5	768	700
	6	648	550
15	5	768	600
	5,5	696	600
	6	648	500
	7	552	450
	7,5	504	400
	8,5	444	350
	9	420	350
22,5	6	424	350
	6,5	392	350
	7	368	300
	8,5	304	250
	10	256	200
	10,5	240	200

Taping specification for axial capacitors acc. to IEC 60286-1

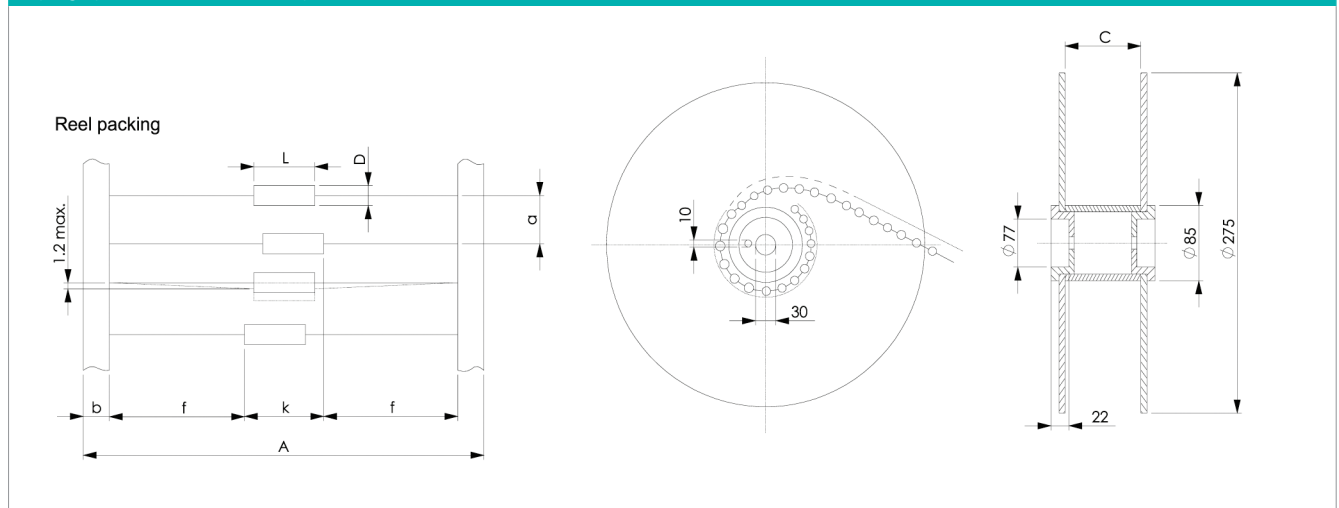

Reel packing

Description	Symbol	Dimensions (mm)
Capacitor diameter	D	4,5 — 19,5
Body length of capacitor	L	11 — 33,5
Outer spacing of tapes	A	See table II
Inner reel width	C	See table II
Tape width	b	6 ± 1
Lead length from the capacitor body to the adhesive tape	f	≥ 20 mm
Body location (permissible lateral deviation)	k	$L_{\text{max}} + 1,4$
Component spacing	a	See table I
Permissible deviation over 10 spacing	Δa	See table I

Table I

D (mm)	a (mm)	Δa (mm)
≤ 5	$5 \pm 0,5$	± 2
5,1 — 9,5	$10 \pm 0,5$	± 2
9,6 — 14,7	$15 \pm 0,75$	± 3
14,8 — 19,5	20 ± 1	± 4

Table II

L_{max} (mm) Body length	A (mm)	C (mm)
≤ 11	75 ± 2	77
14 — 21,5	85 ± 2	87
$\geq 26,5$	95 ± 2	97

Capacitors

Type KFU

Polyester capacitors

As dielectric high quality polyester film is used, electrodes are of tin or aluminium foil. The winding is extended foil design, terminals are electrically welded to electrodes on frontal side. Such version is little inductive and because of good contacting suitable for pulse loading operation.

Typical electrical characteristics of polyester capacitors KFU

Variation of capacitance as a function of temperature

$$\frac{\Delta C}{C} = f(\vartheta) \text{ at } 1 \text{ kHz}$$

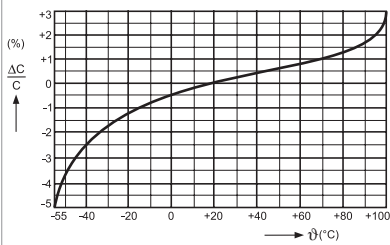

Variation of dissipation factor (tanδ) as a function of frequency

$$\tan \delta = f(f)$$

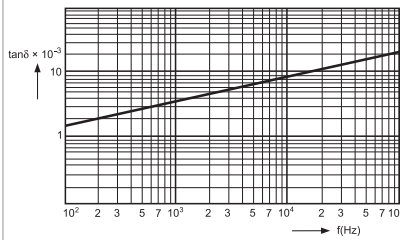

Variation of dissipation factor (tanδ) as a function of temperature

$$\tan \delta = f(\vartheta) \text{ at } 1 \text{ kHz}$$

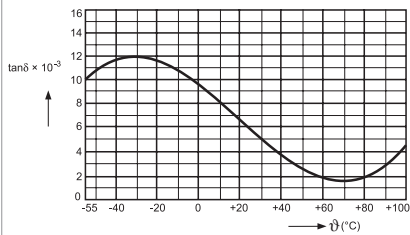

Variation of insulation resistance as a function of temperature

$$R_i = f(\vartheta)$$

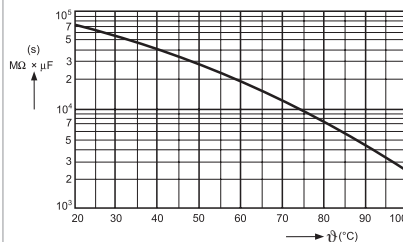

Variation of capacitance as a function of frequency

$$\frac{\Delta C}{C} = f(f)$$

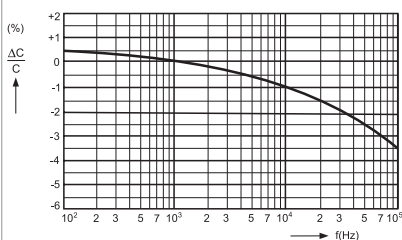

Capacitors

Type KFU1910 radial leads, pitch 10 mm to 27,5 mm

TECHNICAL DATA

General technical data

Dielectric:	polyester (polyethyleneterephthalate) film
Electrodes:	tin or aluminium foil
Winding:	non-inductive construction, flat shape
Leads:	tinned copper wire; standard lengths l_1 : $4^{\pm 0,5}$; 6^{-1} ; $25^{\pm 5}$. Other lead lengths on request.
Encapsulation:	flame-retardant plastic case with flame-retardant epoxy resin seal, UL 94 V-0
Marking:	Iskra symbol, capacitance, tolerance, rated voltage
Climatic category:	55/100/56, IEC 60068-1
Temperature range:	- 55 °C to + 100 °C
Complies with standards:	IEC 60384-11
Electrical data	
Capacitance range:	1000 pF to 1 μ F
Standard values of capacitance (C_R):	range E6
Capacitance tolerance:	$\pm 20\%$ (M), $\pm 10\%$ (K)
Rated voltage (U_R):	100 V DC, 250 V DC, 400 V DC, 630 V DC, 1000 V DC
Allowed alternative voltage up 60 Hz:	63 V AC, 100 V AC, 160 V AC, 200 V AC, 250 V AC
Category voltage (U_C):	to + 85 °C $U_C = U_R$; from + 85 °C to + 100 °C voltage U_R is lowered for 1,25 % per 1 °C
Test voltage:	$2 \times U_R$, 2 s
Dissipation factor ($\tan\delta$):	$\leq 60 \times 10^{-4}$ at 1 kHz at 20 °C
Insulation resistance (R_R):	$\geq 30\,000\text{ M}\Omega$ for $C_R \leq 0,33\ \mu\text{F}$; $R_i \times C_R \geq 10\,000\text{ s}$, for $C_R > 0,33\ \mu\text{F}$
Self inductance:	appr. 10 nH/cm length of capacitor and leads
Soldering on printed circuit boards:	temperature of soldering bath 265 °C max., soldering time 5 s max.
Pulse loading (du/dt):	1000 V/ μ s

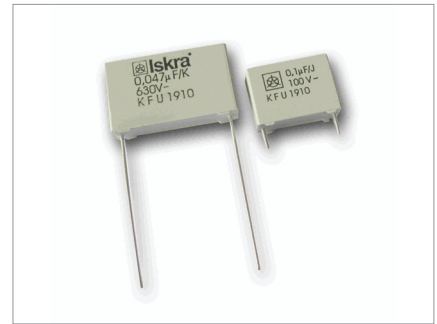

Dimensions in mm

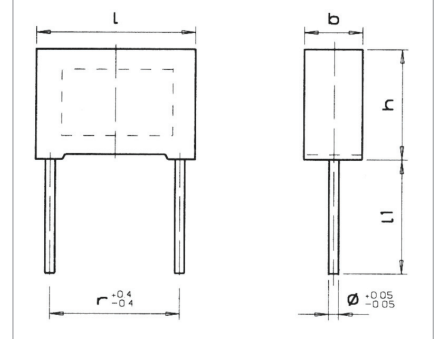

Diameter of leads:

Pitch r (mm)	Diameter of leads ϕ (mm)
10	0,6
15; 22,5; 27,5	0,8

Dimensional data: KFJ1910

Capacitance	Rated voltage U_R																			
	100 V DC				250 V DC				400 V DC				630 V DC				1000 V DC			
	l_{max}	h_{max}	b_{max}	r	l_{max}	h_{max}	b_{max}	r	l_{max}	h_{max}	b_{max}	r	l_{max}	h_{max}	b_{max}	r	l_{max}	h_{max}	b_{max}	r
	(mm)				(mm)				(mm)				(mm)				(mm)			
1000 pF													13	9,5	4,3	10	18	11	5,5	15
1500 pF													13	9,5	4,3	10	18	11	5,5	15
2200 pF													13	9,5	4,3	10	18	11	5,5	15
3300 pF													13	9,5	4,3	10	18	13	7	15
4700 pF									13	9,5	4,3	10	13	10,5	5	10	18	13	7	15
6800 pF									13	9,5	4,3	10	13	11,5	6	10	18	14,5	9	15
0,01 μ F									13	10,5	5	10	13	11,5	6	10	18	14,5	9	15
0,015 μ F					13	10,5	5	10	13	11,5	6	10	18	13	7	15	27	16,5	7	22,5
0,022 μ F	13	9,5	4,3	10	13	10,5	5	10	18	11	5,5	15	18	13	7	15	27	18,5	8,5	22,5
0,033 μ F	13	10,5	5	10	18	11	5,5	15	18	13	7	15	18	14,5	9	15	27	19	10,5	22,5
0,047 μ F	13	11,5	6	10	18	11	5,5	15	18	14,5	9	15	27	15	6,5	22,5	32	20	11	27,5
0,068 μ F	18	11	5,5	15	18	13	7	15	27	15	6,5	22,5	27	18,5	8,5	22,5	32	22,5	13	27,5
0,1 μ F	18	13	7	15	18	14,5	9	15	27	18,5	8,5	22,5	27	19	10,5	22,5				
0,15 μ F	18	14,5	9	15	27	16,5	7	22,5	27	19	10,5	22,5	32	20	11	27,5				
0,22 μ F	18	14,5	9	15	27	18,5	8,5	22,5	32	20	11	27,5	32	22,5	13	27,5				
0,33 μ F	27	18,5	8,5	22,5	32	20	11	27,5	32	22,5	13	27,5								
0,47 μ F	27	19	10,5	22,5	32	22,5	13	27,5												
0,68 μ F	32	20	11	27,5																
0,82 μ F	32	20	11	27,5																
1 μ F	32	22,5	13	27,5																

Capacitors

Type KEU

Metallized polyester capacitors

As a dielectric high quality polyester film with good electrical properties is used. Electrodes of capacitor are vacuum metallized aluminium. The thickness of aluminium is approximately 0,01 μF to 0,04 μF , so the capacitor is self-regenerative after break down. The weak point in dielectric because of un-homogene material in some microseconds regenerate with energy of current bow of charged capacitor. In this process metallized

layer of aluminium in the area of weak point without any damage of dielectric burns out. The weak point is blameless insulated. So metallized capacitor withstands breakdowns without a permanent short circuit with considering self healing resp. regeneration. The majority of weak points are cleared during the high voltage burning-out in the manufacturing process.

Contact surface is made by spraying

the parts of metal contact material. Leads are electrically welded on contact surface. The technology and control system in production assure high liability of capacitors also in use on low voltages and high frequencies. In the case of pulse loading or loading the capacitor with alternative voltage of high gradient of growth is to consider allowed pulse loading du/dt resp. maximal allowed current.

Typical electrical characteristics of metallized polyester capacitors KEU

Variation of capacitance as a function of temperature

$$\frac{\Delta C}{C} = f(\vartheta) \text{ at } 1 \text{ kHz}$$

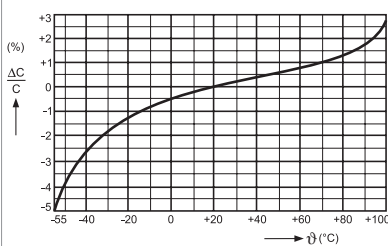

Variation of dissipation factor ($\tan\delta$) as a function of frequency

$$\tan\delta = f(f)$$

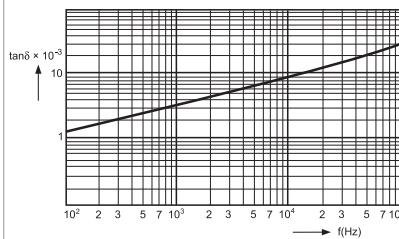

Variation of dissipation factor ($\tan\delta$) as a function of temperature

$$\tan\delta = f(\vartheta) \text{ at } 1 \text{ kHz}$$

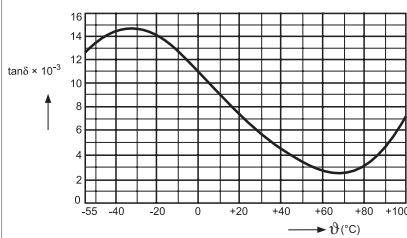

Variation of insulation resistance as a function of temperature

$$R_i = f(\vartheta)$$

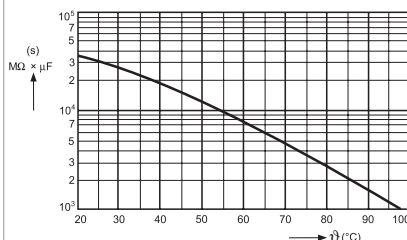

Variation of capacitance as a function of frequency

$$\frac{\Delta C}{C} = f(f)$$

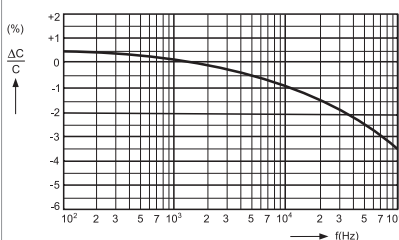

Capacitors

Type KEU1930

Type KEU1930 taped

radial leads, pitch 7,5 mm

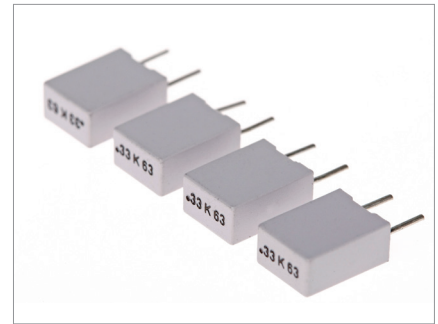

TECHNICAL DATA

General technical data

Dielectric:	polyester (polyethylene terephthalate) film
Electrodes:	vacuum metallized aluminum on dielectric
Winding:	non-inductive flat shape
Leads:	tinned copper wire; standard lengths l_1 : $4^{\pm 0,5}$; 6^{-1} ; $25^{\pm 5}$. Other lead lengths on request.
Encapsulation:	flame-retardant plastic case with flame-retardant epoxy resin seal, UL 94 V-0
Marking:	capacitance, tolerance, rated voltage
Climatic category:	55/100/56, IEC 60068-1
Temperature range:	- 55 °C to + 100 °C
Complies with standards:	IEC 60384-2

KEU 1930 (dimensions in mm)

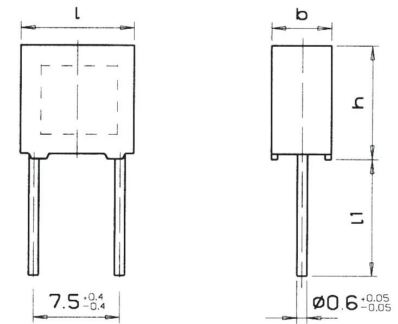

KEU 1930 taped (dimensions in mm)

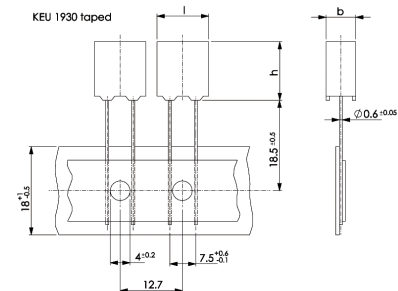

Electrical data

Capacitance range:	1000 pF to 1 μ F
Standard values of capacitance (C_R):	range E6
Capacitance tolerance:	$\pm 20\%$ (M), $\pm 10\%$ (K), and $\pm 5\%$ (J) on special request
Rated voltage (U_R):	63 V DC, 100 V DC, 250 V DC, 400 V DC, 630 V DC
Allowed alternative voltage up to 60 Hz:	40 V AC, 63 V AC, 160 V AC, 200 V AC, 220 V AC
Category voltage (U_C):	to + 85 °C $U_C = U_R$; from + 85 °C to + 100 °C voltage U_R is lowered for 1,25 % per 1 °C
Test voltage:	$1,6 \times U_R$, 2 s
Dissipation factor ($\tan\delta$):	$\leq 100 \times 10^{-4}$ at 1 kHz and 20 °C
Self inductance	≤ 10 nH at leads length 2 mm
Soldering on printed circuit board:	temperature of soldering bath 270 °C max., soldering time 5 s max.
Pulse loading (du/dt):	10 V/ μ s for $U_R = 63$ V DC 15 V/ μ s for $U_R = 100$ V DC 30 V/ μ s for $U_R = 250$ V DC 50 V/ μ s for $U_R = 400$ V DC 70 V/ μ s for $U_R = 630$ V DC

Insulation resistance (R_i) at 20 °C:

Rated capacitance C_R (μF)	Min. R_i or $R_i \times C_R$ between terminals	
	$U_R > 100 \text{ V DC}$	$U_R \leq 100 \text{ V DC}$
$\leq 0,33$	7500 $\text{M}\Omega$	3750 $\text{M}\Omega$
$> 0,33$	2500 s	1250 s

Dimensional data: KEU1930

Capacitance (μF)	Rated voltage U_R														
	63 V DC			100 V DC			250 V DC			400 V DC			630 V DC		
	$l_{\text{max.}}$	$h_{\text{max.}}$	$b_{\text{max.}}$	$l_{\text{max.}}$	$h_{\text{max.}}$	$b_{\text{max.}}$	$l_{\text{max.}}$	$h_{\text{max.}}$	$b_{\text{max.}}$	$l_{\text{max.}}$	$h_{\text{max.}}$	$b_{\text{max.}}$	$l_{\text{max.}}$	$h_{\text{max.}}$	$b_{\text{max.}}$
	(mm)			(mm)			(mm)			(mm)			(mm)		
0,001													10,5	6,5	3,5
0,0015													10,5	6,5	3,5
0,0022													10,5	6,5	3,5
0,0033													10,5	6,5	3,5
0,0047										10,5	6,5	3,5	70,5	9	4
0,0068										10,5	6,5	3,5	10,5	9	4
0,01							10,5	6,5	3,5	10,5	9	4	10,5	11	5
0,015							10,5	6,5	3,5	10,5	9	4	10,5	12	6
0,022							10,5	9	4	10,5	11	5			
0,033				10,5	6,5	3,5	10,5	9	4	10,5	12	6			
0,047				10,5	6,5	3,5	10,5	9	4						
0,068	10,5	6,5	3,5	10,5	9	4	10,5	11	5						
0,1	10,5	6,5	3,5	10,5	9	4	10,5	11	5						
0,15	10,5	6,5	3,5	10,5	9	4	10,5	12	6						
0,22	10,5	9	4	10,5	11	5									
0,33	10,5	9	4	10,5	12	6									
0,47	10,5	11	5												
0,68	10,5	11	5												
1	10,5	12	6												

Taped version details data see page 10

Capacitors

Type KEU1910 radial leads, pitch 10 mm to 27,5 mm

TECHNICAL DATA

General technical data

Dielectric:	polyester (polyethylene terephthalate) film
Electrodes:	vacuum metallized aluminum on dielectric
Winding:	non-inductive flat shape
Leads:	tinned copper wire; standard lengths l_1 : $4^{\pm 0,5}$; 6^{-1} ; $25^{\pm 5}$. Other lead lengths on request.
Encapsulation:	flame-retardant plastic case with flame-retardant epoxy resin seal, UL 94 V-0
Marking:	Iskra symbol, capacitance, tolerance, rated voltage
Climatic category:	55/100/56, IEC 60068-1
Temperature range:	- 55 °C to + 100 °C
Complies with standards:	IEC 60384-2

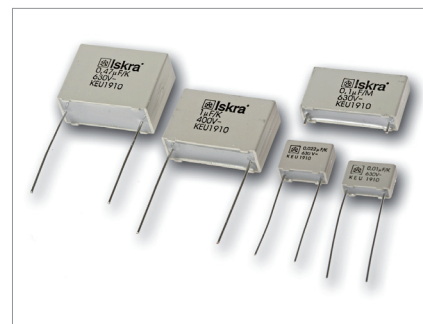

KEU1910 (dimensions in mm)

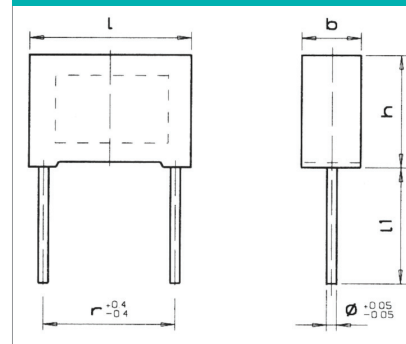

Diameter of leads:

Pitch r (mm)	Diameter of lead ϕ (mm)
10	0,6
15; 22,5; 27,5	0,8

Electrical data

Capacitance range:	1000 pF to 22 μ F
Standard values of capacitance (C_R):	range E6
Capacitance tolerance:	$\pm 20\%$ (M), $\pm 10\%$ (K), and $\pm 5\%$ (J) on special request
Rated voltage (U_R):	63 V DC, 100 V DC, 250 V DC, 400 V DC, 630 V DC, 1000 V DC
Allowed alternative voltage up to 60 Hz:	40 V AC, 63 V AC, 160 V AC, 200 V AC, 220 V AC, 250 V AC
Category voltage (U_C):	up to + 85 °C $U_C = U_R$; from + 85 °C to + 100 °C voltage U_R is lowered for 1,25 % per 1 °C
Test voltage:	$1,6 \times U_R$, 2 s
Dissipation factor ($\tan\delta$):	$\leq 80 \times 10^{-4}$ at 1 kHz and 20 °C
Self inductance	10 nH/cm length of capacitor and leads
Soldering on printed circuit board:	temperature of soldering bath 270 °C max., soldering time 5 s max.
Insulation resistance (R_i) at 20 °C:	

Pulse loading (du/dt):

U_R (V DC)	Pitch r (mm)			
	10	15	22,5	27,5
	Allowed pulse loading (V/ μ s)			
63	9	6	3	2,5
100	12	8	5	4
250	22	14	9	7
400	35	20	12	10
630	45	32	17	13
1000	90	45	26	20

Rated capacitance C_R (μ F)	Min. R_i or $R_i \times C_R$ between terminals	
	$U_R > 100$ V DC	$U_R \leq 100$ V DC
$\leq 0,33$	30000 M Ω	15000 M Ω
$> 0,33$	10000 s	5000 s

Dimensional data: KEU1910

Capacitance (μF)	Rated voltage U _R																								
	63 V DC				100 V DC				250 V DC				400 V DC				630 V DC				1000 V DC				
	l _{max.}	h _{max.}	b _{max.}	r	l _{max.}	h _{max.}	b _{max.}	r	l _{max.}	h _{max.}	b _{max.}	r	l _{max.}	h _{max.}	b _{max.}	r	l _{max.}	h _{max.}	b _{max.}	r	l _{max.}	h _{max.}	b _{max.}	r	
	(mm)				(mm)				(mm)				(mm)				(mm)				(mm)				
0,001																					13	9	4	10	
0,0015																						13	9	4	10
0,0022																						13	9	4	10
0,0033																						13	9	4	10
0,0047																	13	9	4	10	13	9	4	10	
0,0068																	13	9	4	10	13	10,5	5	10	
0,01													13	9	4	10	13	9	4	10	13	11,5	6	10	
0,015													13	9	4	10	13	9	4	10					
0,022													13	9	4	10	13	10,5	5	10					
0,033									13	9	4	10	13	9	4	10	13	11,5	6	10					
0,047									13	9	4	10	13	9	4	10									
0,068					13	9	4	10	13	9	4	10	13	10,5	5	10									
0,1					13	9	4	10	13	9	4	10	13	11,5	6	10									
0,15					13	9	4	10	13	9,5	4,3	10													
0,22	13	9	4	10	13	10,5	5	10	13	10,5	5	10													
0,33	13	9	4	10	13	11,5	6	10																	
0,47	13	9	4	10																					
0,68	13	9,5	4,3	10																					
1	13	10,5	5	10																					
1,5	13	11,5	6	10																					
0,01																						18	11	5	15
0,015																						18	11	5	15
0,022																						18	11	5,5	15
0,033																	18	11	5	15	18	13	7	15	
0,047													18	11	5	15	18	11	5	15	18	14,5	8,5	15	
0,068													18	11	5	15	18	12	6	15	18	16,5	8,5	15	
0,1									18	11	5	15	18	11	5	15	18	13	7	15					
0,15									18	11	5	15	18	11	5	15	18	14,5	8,5	15					
0,22									18	11	5	15	18	12	6	15	18	18,5	9	15					
0,33					18	11	5	15	18	11	5	15	18	13	7	15									
0,47					18	11	5	15	18	12	6	15	18	14,5	8,5	15									
0,68	18	11	5	15	18	12	6	15	18	13	7	15													
1	18	11	5	15	18	13,5	7,5	15	18	14,5	8,5	15													
1,5	18	11	5	15	18	16,5	8,5	15																	
2,2	18	12	6	15																					
3,3	18	13	7	15																					
4,7	18	14,5	8,5	15																					

Taped version details data see page 10

Dimensional data: KEU1910

Capacitance (μ F)	Rated voltage U_R																							
	63 V DC				100 V DC				250 V DC				400 V DC				630 V DC				1000 V DC			
	l_{max}	h_{max}	b_{max}	r	l_{max}	h_{max}	b_{max}	r	l_{max}	h_{max}	b_{max}	r	l_{max}	h_{max}	b_{max}	r	l_{max}	h_{max}	b_{max}	r	l_{max}	h_{max}	b_{max}	r
	(mm)				(mm)				(mm)				(mm)				(mm)				(mm)			
0,033																					26,5	15	6	22,5
0,047																					26,5	15	6	22,5
0,068																					26,5	15	6	22,5
0,1																	26,5	15	6	22,5	26,5	16,5	8,5	22,5
0,15																26,5	15	6	22,5	26,5	18,5	10	22,5	
0,22												26,5	15	6	22,5	26,5	16	7	22,5					
0,33												26,5	15	6	22,5	26,5	18,5	9	22,5					
0,47								26,5	15	6	22,5	26,5	15	6	22,5	26,5	20,5	11	22,5					
0,68								26,5	15	6	22,5	26,5	16	7	22,5									
1								26,5	15	6	22,5	26,5	18,5	9	22,5									
1,5					26,5	16	7	22,5	26,5	16	7	22,5	26,5	20,5	11	22,5								
2,2					26,5	16,5	8,5	22,5	26,5	18,5	9	22,5												
3,3	26,5	15	6	22,5	26,5	18,5	10	22,5	26,5	20,5	11	22,5												
4,7	26,5	15	6	22,5																				
6,8	26,5	16	7	22,5																				
10	26,5	17	8,5	22,5																				
15	26,5	20,5	11	22,5																				
0,15																					32	17	9	27,5
0,22																					32	19	10	27,5
0,33																32	17	9	27,5	32	22	13	27,5	
0,47																32	19	10	27,5	32	24,5	15	27,5	
0,68												32	17	9	27,5	32	21	12	27,5	32	28	18	27,5	
1												32	17	9	27,5	32	23,5	14	27,5					
1,5								32	17	9	27,5	32	19	10	27,5	32	26,5	17	27,5					
2,2								32	17	9	27,5	32	21	12	27,5									
3,3								32	19	10	27,5	32	24,5	15	27,5									
4,7					32	20	11	27,5	32	21	12	27,5	32	28	18	27,5								
6,8					32	22	13	27,5	32	24,5	15	27,5												
10	32	17	9	27,5	32	28,5	15	27,5	32	28	18	27,5												
15	32	20	11	27,5																				
22	32	21	12	27,5																				

Taped version details data see page 11

Capacitors

Type KEU1012

axial leads

TECHNICAL DATA

General technical data

Dielectric:	polyester (polyethylene terephthalate) film
Electrodes:	vacuum metallized aluminum on dielectric
Winding:	non-inductive construction, cylindrical shape
Leads:	tinned copper wire
Encapsulation:	polyester film, ends sealed with epoxy resin
Marking:	capacitance, tolerance, rated voltage (at larger dimensions also Iskra symbol, type designation)
Climatic category:	55/100/21, IEC 60068-1
Temperature range:	- 55 °C to + 100 °C
Complies with standards:	IEC 60384-2

Electrical data

Capacitance range:	1000 pF to 10 μF
Standard values of capacitance (C_R):	range E6
Capacitance tolerance:	± 20 % (M), ± 10 % (K), and ± 5 % (J) on special request
Rated voltage (U_R):	63 V DC, 100 V DC, 250 V DC, 400 V DC, 630 V DC, 1000 V DC
Allowed alternative voltage up to 60 Hz:	440 V AC, 63 V AC, 160 V AC, 200 V AC, 220 V AC, 250 V AC
Category voltage (U_C):	up to + 85 °C $U_C = U_R$; from + 85 °C to + 100 °C voltage U_R is lowered for 1,25 % per 1 °C
Test voltage:	1,6 × U_R , 2 s
Dissipation factor ($\tan\delta$):	≤ 80 × 10 ⁻⁴ at 1 kHz and 20 °C
Self inductance	10 nH/cm length of capacitor and leads
Soldering on printed circuit board:	temperature of soldering bath 270 °C max., soldering time 5 s max.
Insulation resistance (R_i) at 20 °C:	

Rated capacitance C_R (μF)	Min. R_i or $R_i \times C_R$ between terminals	
	$U_R > 100$ V DC	$U_R \leq 100$ V DC
≤ 0,33	30000 MΩ	15000 MΩ
> 0,33	10000 s	5000 s

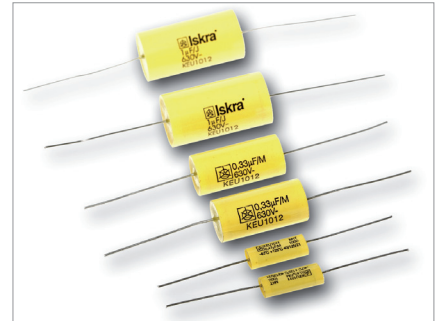

KEU1012 (dimensions in mm)

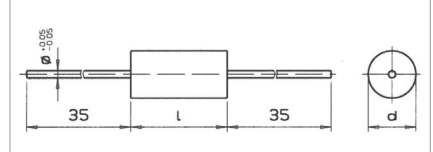

Diameter of leads:

Capacitor length l_{max} (mm)	Diameter of leads ϕ (mm)
11; 14; 19	0,6
26,5; 31,5	0,8

Pulse loading (du/dt):

U_R (V DC)	l_{max} (mm)				
	11	14	19	26,5	31,5
	Allowed pulse loading (V/μs)				
63	12	9	6	3	2,5
100	18	12	8	5	4
250	32	22	14	9	7
400	55	35	20	12	10
630	70	45	32	17	13
1000	-	90	45	26	20

Dimensional data: KEU1012

Capacitance (μF)	Rated voltage U_R											
	63 V DC		100 V DC		250 V DC		400 V DC		630 V DC		1000 V DC	
	$d_{\text{max.}}$	$l_{\text{max.}}$	$d_{\text{max.}}$	$l_{\text{max.}}$	$d_{\text{max.}}$	$l_{\text{max.}}$	$d_{\text{max.}}$	$l_{\text{max.}}$	$d_{\text{max.}}$	$l_{\text{max.}}$	$d_{\text{max.}}$	$l_{\text{max.}}$
	(mm)		(mm)		(mm)		(mm)		(mm)		(mm)	
0,001									5	11	5	14
0,0015									5	11	5	14
0,0022									5	11	5	14
0,0033									5	11	5,5	14
0,0047									5	11	6	14
0,0068									5,5	11	7	14
0,01							5	11	5	14	6	19
0,015							5	11	5,5	14	6,5	19
0,022							5	11	6,5	14	7,5	19
0,033							5,5	11	6	19	8,5	19
0,047					5	11	5,5	14	6,5	19	10	19
0,068			5	11	5,5	11	6	14	7,5	19	9	26,5
0,1			5	11	5,5	14	7	14	9	19	10,5	26,5
0,15	5	11	5	11	6	14	6,5	19	8,5	26,5	11,5	31,5
0,22	5	11	6	11	7	14	7,5	19	10	26,5	13,5	31,5
0,33	5,5	11	6	14	6,5	19	9	19	12	26,5	16	31,5
0,47	6	14	6,5	14	7,5	19	8,5	26,5	12,5	31,5	18,5	31,5
0,68	6	14	7,5	14	8,5	19	10	26,5	14,5	31,5		
1	7	14	7	19	8,5	26,5	10,5	31,5	17,5	31,5		
1,5	6,5	19	8,5	19	10	26,5	12,5	31,5				
2,2	7,5	19	9,5	19	11	31,5	15	31,5				
3,3	9	19	9,5	26,5	13	31,5	18	31,5				
4,7	9	26,5	11	26,5	15	31,5						
6,8	10	26,5	12	31,5	18	31,5						
10	10,5	31,5	14	31,5	21	31,5						

Taped version details data see page 12

Capacitors

Type KLI

Polypropylene capacitors

As a dielectric a high quality polypropylene film with excellent electrical properties is used. The electrodes are of aluminium foil and vacuum evaporated metal on polypropylene film for internal serial connection. Winding is extended foil design and enables contacting

of leads on aluminium electrodes for high currents. Capacitors are suitable for operating in pulse circuits (for instance in TV sets in thyristor or transistor deflection steps) where high pulse loading appear.

Typical electrical characteristics of polypropylene polyester capacitors KLI

Variation of capacitance as a function of temperature

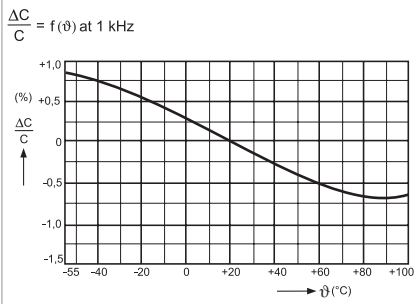

Variation of dissipation factor (tanδ) as a function of frequency

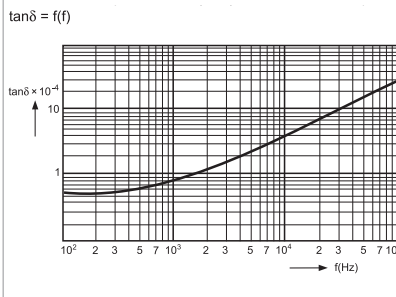

Variation of dissipation factor (tanδ) as a function of temperature

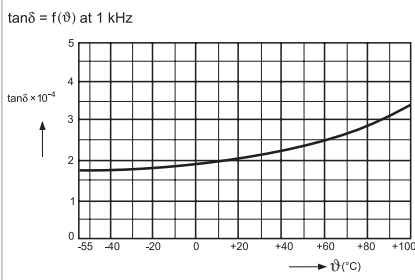

Variation of insulation resistance as a function of temperature

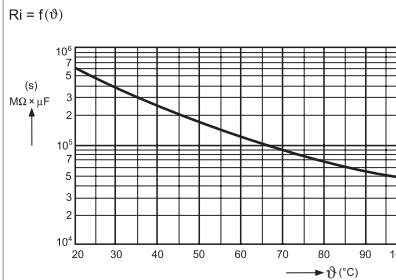

Variation of capacitance as a function of frequency

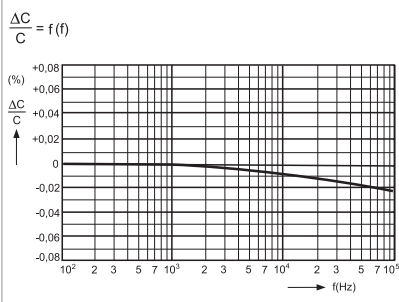

Capacitors

Type KLI1910

radial leads, pitch 7,5 mm to 27,5 mm

TECHNICAL DATA

General technical data

Dielectric:	polypropylene film
Electrodes:	metal foil; metal foil and metallized polypropylene film (internal series connection for $U_R \geq 630V$ DC and $r \geq 15mm$)
Winding:	non-inductive construction, flat shape
Leads:	tinned copper wire, standard lengths l_1 : $4^{\pm 0,5}$; 6^{-1} ; $25^{\pm 5}$. Other lead lengths on request.
Encapsulation:	flame-retardant plastic case with flame-retardant epoxy resin seal, UL 94 V-0
Marking:	Iskra symbol, capacitance, tolerance, rated voltage, type designation
Climatic category:	55/100/56 IEC 60068-1
Temperature range:	- 55 °C to + 100 °C
Complies with standards:	IEC 60384-13; IEC 60384-16

Electrical data

Capacitance range:	100 pF to 0,22 μ F
Standard values of capacitance (C_R):	range E6 and E12
Capacitance tolerance:	$\pm 20\%$ (M), $\pm 10\%$ (K), and $\pm 5\%$ (J)
Rated voltage (U_R):	100 V DC, 160 V DC, 250 V DC, 400 V DC, 630 V DC, 1000 V DC, 1600 V DC, 2000 V DC
Allowed alternative voltage up to 60 Hz:	63 V AC, 90 V AC, 125 V AC, 160 V AC, 200 V AC (for 630 V DC, $r \leq 10$ mm), 300 V AC, 400 V AC, 500 V AC, 600 V AC
Category voltage (U_C):	up to + 85 °C $U_C = U_R$; from + 85 °C to + 100 °C voltage U_R is lowered for 1,25 % per 1 °C
Test voltage:	$2 \times U_R$ (for $U_R \leq 630$ V), 2s; $1,6 \times U_R$ (for $U_R \geq 630$ V and $r \geq 15$ mm), 2s
Dissipation factor ($\tan\delta$):	$\leq 5 \times 10^{-4}$ at 1 kHz and 20 °C $\leq 6 \times 10^{-4}$ at 10 kHz and 20 °C $\leq 10 \times 10^{-4}$ at 100 kHz and 20 °C for $C_R \leq 0,1 \mu$ F.
Insulation resistance (R_i) at 20 °C:	≥ 100000 M Ω
Soldering on printed circuit board:	temperature of soldering bath 270 °C max., soldering time 5 s max.

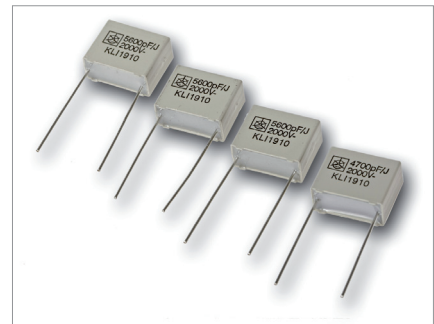

KLI1910 (dimensions in mm)

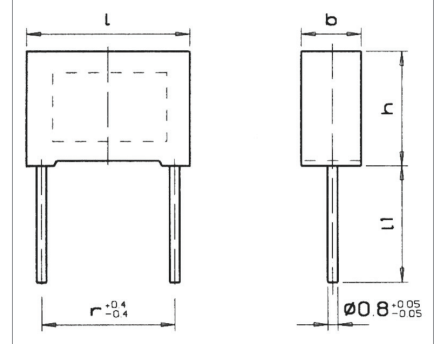

Diameter of leads:

Pitch r (mm)	Diameter of leads ϕ (mm)
7,5; 10	0,6
15; 22,5; 27,5	0,8

Typical application:

Switching circuits in electronic ballast; applications with high voltage and very high current.

Pulse loading (du/dt):

U_R (V DC)	Pitch r (mm)				
	7,5	10	15	22,5	27,5
100	9000	4500	2200	-	-
160	11000	5500	2700	-	-
250	18000	9300	4500	-	-
400	25000	13000	6100	-	-
630	31000	16000	8000	3500	2700
1000	-	-	10900	4700	3600
1600	-	-	16400	8200	6100
2000	-	-	20500	10200	7700

Dimensional data - r7,5 mm: KLI1910

Capacitance (μ F)	Rated voltage U_R																			
	100 V DC/63 V AC				160 V DC/90V AC				250 V DC/125V AC				400 V DC/160V AC				630V DC/200V AC			
	$l_{max.}$	$h_{max.}$	$b_{max.}$	r	$l_{max.}$	$h_{max.}$	$b_{max.}$	r	$l_{max.}$	$h_{max.}$	$b_{max.}$	r	$l_{max.}$	$h_{max.}$	$b_{max.}$	r	$l_{max.}$	$h_{max.}$	$b_{max.}$	r
	(mm)				(mm)				(mm)				(mm)				(mm)			
0,0001																	10,5	9	4	7,5
0,00015																	10,5	9	4	7,5
0,00022																	10,5	9	4	7,5
0,00033																	10,5	9	4	7,5
0,00047																	10,5	9	4	7,5
0,00068																	10,5	9	4	7,5
0,001													10,5	9	4	7,5	10,5	9	4	7,5
0,0015													10,5	9	4	7,5	10,5	11	5	7,5
0,0022									10,5	9	4	7,5	10,5	11	5	7,5	10,5	12	6	7,5
0,0033					10,5	9	4	7,5	10,5	9	4	7,5	10,5	12	6	7,5				
0,0047					10,5	9	4	7,5	10,5	11	5	7,5								
0,0068	10,5	9	4	7,5	10,5	9	4	7,5	10,5	12	6	7,5								
0,01	10,5	9	4	7,5	10,5	11	5	7,5												
0,015	10,5	11	5	7,5	10,5	12	6	7,5												
0,022	10,5	12	6	7,5																

Taped version details data see page 10

Dimensional data - r10 mm: KLI1910

Capacitance (μ F)	Rated voltage U_R																				
	100 V DC/63 V AC				160 V DC/90V AC				250 V DC/125V AC				400 V DC/160V AC				630V DC/200V AC				
	$l_{max.}$	$h_{max.}$	$b_{max.}$	r	$l_{max.}$	$h_{max.}$	$b_{max.}$	r	$l_{max.}$	$h_{max.}$	$b_{max.}$	r	$l_{max.}$	$h_{max.}$	$b_{max.}$	r	$l_{max.}$	$h_{max.}$	$b_{max.}$	r	
	(mm)				(mm)				(mm)				(mm)				(mm)				
0,0015																	13	9	4	10	
0,0022													13	9	4	10	13	10,5	5	10	
0,0033										13	9	4	10	13	10,5	5	10	13	11,5	6	10
0,0047										13	9	4	10	13	10,5	5	10	13	12	6	10
0,0068					13	9	4	10	13	10,5	5	10	13	11,5	6	10					
0,01					13	9	4	10	13	11,5	6	10									
0,015	13	9	4	10	13	10,5	5	10													
0,022	13	10,5	5	10	13	11,5	6	10													
0,033	13	11,5	6	10																	

Taped version details data see page 11

Dimensional data - r15 mm: KLI1910

Capacitance (μ F)	Rated voltage U_R															
	100 V AC/63 V AC				160 V DC/90V AC				250 V DC/125V AC				400 V DC/160V AC			
	l_{max}	h_{max}	b_{max}	r	l_{max}	h_{max}	b_{max}	r	l_{max}	h_{max}	b_{max}	r	l_{max}	h_{max}	b_{max}	r
	(mm)				(mm)				(mm)				(mm)			
0,01													18	11	5	15
0,015									18	11	5	15	18	12	6	15
0,022									18	11	5,5	15	18	13,5	7,5	15
0,033					18	11	5	15	18	12	7	15	18	16,5	8,5	15
0,047	18	11	5	15	18	11	5,5	15	18	13,5	7,5	15	18	18,5	9	15
0,068	18	12	6	15	18	12	7	15								
0,1	18	12	7	15	18	13,5	7,5	15								
0,15	18	14,5	8,5	15												

Taped version details data see page 11

Dimensional data - r15 mm - Internal series connection: KLI1910

Capacitance (μ F)	Rated voltage U_R															
	630 V DC/300 V AC				1000V DC/400V AC				1600 V DC/500V AC				2000 V DC/600V AC			
	l_{max}	h_{max}	b_{max}	r	l_{max}	h_{max}	b_{max}	r	l_{max}	h_{max}	b_{max}	r	l_{max}	h_{max}	b_{max}	r
	(mm)				(mm)				(mm)				(mm)			
0,001					18	11	5	15	18	11	5	15	18	11	5	15
0,0012					18	11	5	15	18	11	5	15	18	11	5	15
0,0015					18	11	5	15	18	11	5	15	18	11	5	15
0,0018					18	11	5	15	18	11	5	15	18	11	5	15
0,0022					18	11	5	15	18	11	5	15	18	11	5,5	15
0,0027					18	11	5	15	18	11	5	15	18	12	6	15
0,0033	18	11	5	15	18	11	5	15	18	11	5,5	15	18	13	7	15
0,0039	18	11	5	15	18	11	5	15	18	12	6	15	18	13	7	15
0,0047	18	11	5	15	18	11	5	15	18	13	7	15	18	14,5	8,5	15
0,0056	18	11	5	15	18	11	5	15	18	13	7	15	18	14,5	8,5	15
0,0068	18	11	5	15	18	11	5,5	15	18	13,5	7,5	15				
0,0082	18	11	5	15	18	12	6	15	18	14,5	8,5	15				
0,01	18	11	5,5	15	18	13	7	15								
0,012	18	12	6	15	18	13,5	7,5	15								
0,015	18	13	7	15	18	14,5	8,5	15								
0,018	18	13	7	15	18	16,5	8,5	15								
0,022	18	14,5	8,5	15												
0,027	18	16,5	8,5	15												

Taped version details data see page 11

Dimensional data - r22,5 mm - Internal series connection: KLI1910

Capacitance (μ F)	Rated voltage U_R															
	630 V DC/300 V AC				1000V DC/400V AC				1600 V DC/500V AC				2000 V DC/600V AC			
	$l_{max.}$	$h_{max.}$	$b_{max.}$	r	$l_{max.}$	$h_{max.}$	$b_{max.}$	r	$l_{max.}$	$h_{max.}$	$b_{max.}$	r	$l_{max.}$	$h_{max.}$	$b_{max.}$	r
	(mm)				(mm)				(mm)				(mm)			
0,0068													26,5	15	6	22,5
0,0082													26,5	16	7	22,5
0,01								26,5	15	6	22,5	26,5	16,5	7,5	22,5	
0,012								26,5	16	7	22,5	26,5	17	8,5	22,5	
0,015								26,5	16,5	7,5	22,5	26,5	18,5	9	22,5	
0,018								26,5	17	8,5	22,5	26,5	20,5	11	22,5	
0,022					26,5	15	6	22,5	26,5	18,5	9	22,5				
0,027					26,5	16	7	22,5	26,5	20,5	11	22,5				
0,033	26,5	15	6	22,5	26,5	16	7	22,5								
0,039	26,5	15	6	22,5	26,5	17	8,5	22,5								
0,047	26,5	16	7	22,5	26,5	18,5	9	22,5								
0,056	26,5	16,5	7,5	22,5	26,5	18,5	10	22,5								
0,068	26,5	17	8,5	22,5	26,5	20,5	11	22,5								
0,082	26,5	18,5	9	22,5												
0,1	26,5	20,5	11	22,5												

Taped version details data see page 11

Dimensional data - r27,5 mm - Internal series connection: KLI1910

Capacitance (μ F)	Rated voltage U_R															
	630 V DC/300 V AC				1000V DC/400V AC				1600 V DC/500V AC				2000 V DC/600V AC			
	$l_{max.}$	$h_{max.}$	$b_{max.}$	r	$l_{max.}$	$h_{max.}$	$b_{max.}$	r	$l_{max.}$	$h_{max.}$	$b_{max.}$	r	$l_{max.}$	$h_{max.}$	$b_{max.}$	r
	(mm)				(mm)				(mm)				(mm)			
0,022													32	19	10	27,5
0,027													32	20	11	27,5
0,033								32	19	10	27,5	32	21	12	27,5	
0,039								32	20	11	27,5	32	23,5	14	27,5	
0,047								32	21	12	27,5	32	24,5	15	27,5	
0,056								32	23,5	14	27,5					
0,068								32	24,5	15	27,5					
0,082					32	19	10	27,5	32	26,5	17	27,5				
0,1					32	21	12	27,5	32	28	18	27,5				
0,12	32	19	10	27,5	32	21	12	27,5								
0,15	32	20	11	27,5	32	23,5	14	27,5								
0,18	32	21	12	27,5	32	26,5	17	27,5								
0,22	32	23,5	14	27,5	32	26,5	17	27,5								

Capacitors

Type KNI

Metallized polypropylene capacitors

As a dielectric a high quality polypropylene film of excellent electrical properties is used. Electrodes of capacitors are of double sides vacuum metallized aluminium on polyester film. Winding is cylindrical extended foil design. Such construction enables very good contacting and is able to translate higher currents.

The capacitor has the property to regenerate after break-down. Capacitors are suitable for use in high pulse loading (for instance in TV sets for "S" correction) because of self regenerative properties and low loss angle, where common types of metallized capacitors do not comply the requirements.

Typical electrical characteristics of metallized polypropylene capacitors KNI

Variation of capacitance as a function of temperature

$$\frac{\Delta C}{C} = f(\vartheta) \text{ at } 1 \text{ kHz}$$

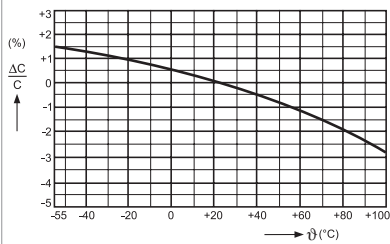

Variation of dissipation factor (tanδ) as a function of frequency

$$\tan\delta = f(f)$$

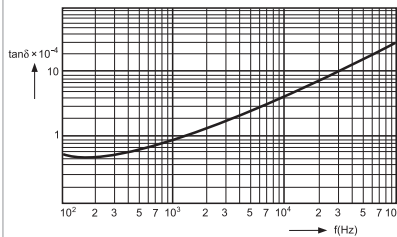

Variation of dissipation factor (tanδ) as a function of temperature

$$\tan\delta = f(\vartheta) \text{ at } 1 \text{ kHz}$$

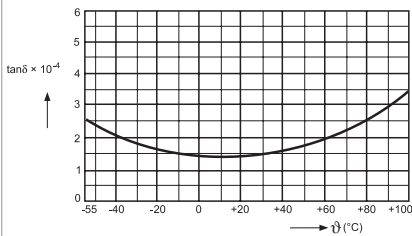

Variation of insulation resistance as a function of temperature

$$R_i = f(\vartheta)$$

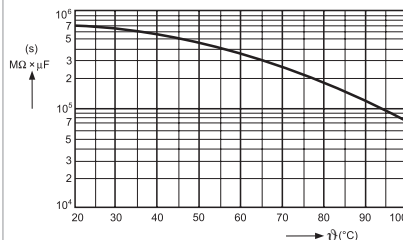

Variation of capacitance as a function of frequency

$$\frac{\Delta C}{C} = f(f)$$

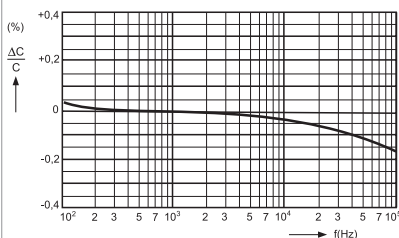

Capacitors

Type KNI1910 radial leads, pitch 7,5 mm to 27,5 mm

TECHNICAL DATA

General technical data

Dielectric:	polypropylene film
Electrodes:	double-sided metallized polyester film and metallized polypropylene film (internal series connection for for $U_R \geq 630V$ DC and $r \geq 15mm$)
Winding:	non-inductive construction, flat shape
Leads:	tinned copper wire, standard lengths l_1 : $4^{\pm 0,5}$; 6^{-1} ; $25^{\pm 5}$. Other lead lengths on request.
Encapsulation:	flame-retardant plastic case with flame-retardant epoxy resin seal, UL 94 V-0
Marking:	Iskra symbol, capacitance, tolerance, rated voltage, type designation
Climatic category:	55/100/56 IEC 60068-1
Temperature range:	- 55 °C to + 100 °C
Complies with standards:	IEC 60384-16; IEC 60384-17

Electrical data

Capacitance range:	680 pF to 2,2 μ F
Standard values of capacitance (C_R):	range E12
Capacitance tolerance:	$\pm 20\%$ (M), $\pm 10\%$ (K), and $\pm 5\%$ (J)
Rated voltage (U_R):	250 V DC, 400 V DC, 630 V DC, 1000 V DC, 1600 V DC, 2000 V DC
Allowed alternative voltage up to 60 Hz:	180 V AC, 250 V AC, 300 V AC, 400 V AC, 500V AC, 630 V AC, 650 V AC
Category voltage (U_C):	up to + 85 °C $U_C = U_R$; from + 85 °C to + 100 °C voltage U_R is lowered for 1,25 % per 1 °C
Test voltage:	$1,6 \times U_R$, 2 s
Insulation resistance (R_i):	$\geq 100000 M\Omega$ at 20 °C for $C_R \leq 0,33 \mu F$ $R_i \times C_R \geq 30000$ s at 20 °C for $C_R > 0,33 \mu F$
Soldering on printed circuit boards:	temperature of soldering bath 270 °C max., soldering time 5 s max.
Dissipation factor ($\tan\delta$):	$\leq 3 \times 10^{-4}$ at 1 kHz and 20 °C, $\leq 6 \times 10^{-4}$ at 10 kHz and 20 °C for $C_R \leq 1 \mu F$ $\leq 15 \times 10^{-4}$ at 100 kHz and 20 °C for $C_R \leq 0,1 \mu F$.

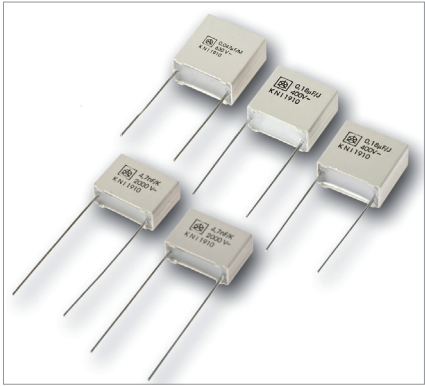

KNI1910 (dimensions in mm)

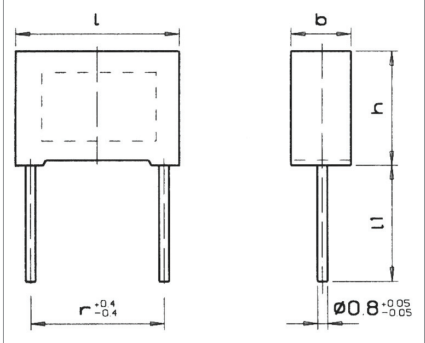

Diameter of leads:

Pitch (mm)	Diameter of leads ϕ (mm)
7,5; 10	0,6
15; 22,5; 27,5	0,8

Typical application:

Deflection circuits in TV-sets; protection circuits in SMPS (switch mode power supplies) and in electronic ballast; applications with high voltage and current.

Pulse loading (du/dt):

U_R (V DC)	Pitch r (mm)				
	7,5	10	15	22,5	27,5
	Allowed pulse loading (V/ μ s)				
250	1500	1100	750	450	300
400	1800	1600	1000	600	500
630	2800	1800	2500	1500	1000
1000	-	-	3200	2000	1200
1600	-	-	4500	2500	1800
2000	-	-	7000	3200	2200

Dimensional data - r7,5 mm: KNI1910

Capacitance (μ F)	Rated voltage U_R											
	250V DC/180V AC				400V DC/250V AC				630V DC/300V AC			
	$l_{max.}$	$h_{max.}$	$b_{max.}$	r	$l_{max.}$	$h_{max.}$	$b_{max.}$	r	$l_{max.}$	$h_{max.}$	$b_{max.}$	r
	(mm)				(mm)				(mm)			
0,00068	10,5	8	4	7,5	10,5	8	4	7,5	10,5	8	4	7,5
0,00082	10,5	8	4	7,5	10,5	8	4	7,5	10,5	8	4	7,5
0,001	10,5	8	4	7,5	10,5	8	4	7,5	10,5	8	4	7,5
0,0012	10,5	8	4	7,5	10,5	8	4	7,5	10,5	8	4	7,5
0,0015	10,5	8	4	7,5	10,5	8	4	7,5	10,5	8	4	7,5
0,0018	10,5	8	4	7,5	10,5	8	4	7,5	10,5	8	4	7,5
0,0022	10,5	8	4	7,5	10,5	8	4	7,5	10,5	8	4	7,5
0,0027	10,5	8	4	7,5	10,5	8	4	7,5	10,5	8	4	7,5
0,0033	10,5	8	4	7,5	10,5	8	4	7,5	10,5	8	4	7,5
0,0039	10,5	8	4	7,5	10,5	8	4	7,5	10,5	8	4	7,5
0,0047	10,5	8	4	7,5	10,5	8	4	7,5	10,5	8	4	7,5
0,0056	10,5	8	4	7,5	10,5	8	4	7,5	10,5	8	4	7,5
0,0068	10,5	8	4	7,5	10,5	8	4	7,5	10,5	8	4	7,5
0,0082	10,5	8	4	7,5	10,5	8	4	7,5	10,5	9	4	7,5
0,01	10,5	8	4	7,5	10,5	8	4	7,5	10,5	10	5	7,5
0,012	10,5	8	4	7,5	10,5	8	4	7,5	10,5	10	5	7,5
0,015	10,5	8	4	7,5	10,5	9	4	7,5	10,5	11	5	7,5
0,018	10,5	8	4	7,5	10,5	9	4	7,5	10,5	11	5,5	7,5
0,022	10,5	9	4	7,5	10,5	10	5	7,5	10,5	12	6	7,5
0,027	10,5	10	5	7,5	10,5	11	5	7,5				
0,033	10,5	10	5	7,5	10,5	11	5,5	7,5				
0,039	10,5	11	5	7,5	10,5	12	6	7,5				
0,047	10,5	12	6	7,5								
0,056	10,5	12	6	7,5								

Dimensional data - r10 mm: KNI1910

Capacitance (μ F)	Rated voltage U_R											
	250V DC/180V AC				400V DC/250V AC				630V DC/300V AC			
	$l_{max.}$	$h_{max.}$	$b_{max.}$	r	$l_{max.}$	$h_{max.}$	$b_{max.}$	r	$l_{max.}$	$h_{max.}$	$b_{max.}$	r
	(mm)				(mm)				(mm)			
0,001									13	9	4	10
0,0012									13	9	4	10
0,0015									13	9	4	10
0,0018									13	9	4	10
0,0022									13	9	4	10
0,0027									13	9	4	10
0,0033									13	9	4	10
0,0039									13	9	4	10
0,0047									13	9	4	10
0,0056									13	9	4	10
0,0068									13	9	4	10
0,0082									13	9	4	10
0,01	13	9	4	10	13	9	4	10	13	9	4	10
0,012	13	9	4	10	13	9	4	10	13	9	4	10
0,015	13	9	4	10	13	9	4	10	13	9	4	10
0,018	13	9	4	10	13	9	4	10	13	10,5	5	10
0,022	13	9	4	10	13	9,5	4,3	10	13	10,5	5	10
0,027	13	9	4	10	13	10,5	5	10	13	11,5	6	10
0,033	13	10,5	5	10	13	10,5	5	10	13	12	6	10
0,039	13	10,5	5	10	13	11,5	6	10	13	12	6	10
0,047	13	11,5	6	10	13	12	6	10				
0,056	13	11,5	6	10								
0,068	13	12	6	10								

Dimensional data - r15 mm: KNI1910

Capacitance (μF)	Rated voltage U _R																							
	250V DC/180V AC				400V DC/250V AC				630V DC/400V AC				1000V DC/500V AC				1600V DC/630V AC				2000V DC/650V AC			
	l _{max.}	h _{max.}	b _{max.}	r	l _{max.}	h _{max.}	b _{max.}	r	l _{max.}	h _{max.}	b _{max.}	r	l _{max.}	h _{max.}	b _{max.}	r	l _{max.}	h _{max.}	b _{max.}	r	l _{max.}	h _{max.}	b _{max.}	r
	(mm)				(mm)				(mm)				(mm)				(mm)				(mm)			
0,001																	18	11	5	15	18	11	5	15
0,0012																	18	11	5	15	18	11	5	15
0,0015																	18	11	5	15	18	11	5	15
0,0018																	18	11	5	15	18	11	5	15
0,0022																	18	11	5	15	18	11	5	15
0,0027																	18	11	5	15	18	11	5	15
0,0033													18	11	5	15	18	11	5	15	18	11	5,5	15
0,0039													18	11	5	15	18	11	5	15	18	12	6	15
0,0047													18	11	5	15	18	11	5,5	15	18	12	7	15
0,0056													18	11	5	15	18	12	6	15	18	13	7	15
0,0068													18	11	5	15	18	12	7	15	18	13,5	7,5	15
0,0082													18	11	5	15	18	13	7	15	18	14,5	8,5	15
0,01								18	11	5	15	18	11	5,5	15	18	13,5	7,5	15	18	16	9,5	15	
0,012								18	11	5	15	18	12	6	15	18	14,5	8,5	15	18	18,5	9	15	
0,015								18	12	6	15	18	12	7	15	18	16	9,5	15	18	18,5	11	15	
0,018								18	12	7	15	18	13	7	15	18	18,5	9	15					
0,022								18	13	7	15	18	14,5	8,5	15	18	18,5	11	15					
0,027								18	13,5	7,5	15	18	16,5	8,5	15	18	20	12,5	15					
0,033					18	11	5	15	18	14,5	8,5	15	18	18,5	9	15								
0,039					18	11	5	15	18	16,5	8,5	15	18	18,5	11	15								
0,047	18	11	5	15	18	11	5	15	18	18,5	9	15												
0,056	18	11	5	15	18	11	5	15	18	18,5	11	15												
0,068	18	11	5	15	18	12	6	15	18	20	12,5	15												
0,082	18	11	5,5	15	18	12	6	15																
0,1	18	12	6	15	18	13	7	15																
0,12	18	12	7	15	18	13,5	7,5	15																
0,15	18	13,5	7,5	15	18	14,5	8,5	15																
0,18	18	14,5	8,5	15	18	16,5	8,5	15																
0,22	18	16,5	8,5	15	18	18,5	9	15																
0,27	18	18,5	9	15																				
0,33	18	18,5	11	15																				
0,39	18	20	12,5	15																				

Dimensional data - r22,5 mm: KNI1910

Capacitance (μ F)	Rated voltage U_R																								
	250V DC/180V AC				400V DC/250V AC				630V DC/400V AC				1000V DC/500V AC				1600V DC/630V AC				2000V DC/650V AC				
	$l_{max.}$	$h_{max.}$	$b_{max.}$	r	$l_{max.}$	$h_{max.}$	$b_{max.}$	r	$l_{max.}$	$h_{max.}$	$b_{max.}$	r	$l_{max.}$	$h_{max.}$	$b_{max.}$	r	$l_{max.}$	$h_{max.}$	$b_{max.}$	r	$l_{max.}$	$h_{max.}$	$b_{max.}$	r	
	(mm)				(mm)				(mm)				(mm)				(mm)				(mm)				
0,0033																					26,5	14	6	22,5	
0,0039																						26,5	14	6	22,5
0,0047																						26,5	14	6	22,5
0,0056																						26,5	14	6	22,5
0,0068																						26,5	14	6	22,5
0,0082																						26,5	14	6	22,5
0,01																		26,5	14	6	22,5	26,5	15	6	22,5
0,012																		26,5	14	6	22,5	26,5	15,5	7,5	22,5
0,015																		26,5	15	6	22,5	26,5	16,5	8,5	22,5
0,018																		26,5	15,5	7,5	22,5	26,5	17	8,5	22,5
0,022													26,5	14	6	22,5	26,5	16,5	7,5	22,5	26,5	18,5	10	22,5	
0,027													26,5	14	6	22,5	26,5	17	8,5	22,5	26,5	20,5	11	22,5	
0,033								26,5	14	6	22,5	26,5	15	6	22,5	26,5	18,5	10	22,5	26,5	21,5	12,5	22,5		
0,039								26,5	15	6	22,5	26,5	16	7	22,5	26,5	20,5	11	22,5						
0,047								26,5	16	7	22,5	26,5	16,5	8,5	22,5	26,5	21,5	12,5	22,5						
0,056								26,5	16,5	7,5	22,5	26,5	17	8,5	22,5	26,5	21,5	12,5	22,5						
0,068								26,5	17	8,5	22,5	26,5	18,5	10	22,5										
0,082								26,5	18,5	9	22,5	26,5	20,5	11	22,5										
0,1								26,5	18,5	10	22,5	26,5	21,5	12,5	22,5										
0,12					26,5	14	6	22,5	26,5	20,5	11	22,5													
0,15					26,5	14	6	22,5	26,5	21,5	12,5	22,5													
0,18	26,5	14	6	22,5	26,5	15	6	22,5																	
0,22	26,5	15	6	22,5	26,5	16	7	22,5																	
0,27	26,5	16	7	22,5	26,5	16,5	8,5	22,5																	
0,33	26,5	16,5	8,5	22,5	26,5	18,5	9	22,5																	
0,39	26,5	17	8,5	22,5	26,5	18,5	10	22,5																	
0,47	26,5	18,5	9	22,5	26,5	20,5	11	22,5																	
0,56	26,5	18,5	10	22,5																					
0,68	26,5	20,5	11	22,5																					
0,82	26,5	21,5	12,5	22,5																					

Dimensional data - r 27,5 mm: KNI1910

Capacitance (μ F)	Rated voltage U_R																																		
	250V DC/180V AC				400V DC/250V AC				630V DC/400V AC				1000V DC/500V AC				1600V DC/630V AC				2000V DC/650V AC														
	$l_{max.}$	$h_{max.}$	$b_{max.}$	r	$l_{max.}$	$h_{max.}$	$b_{max.}$	r	$l_{max.}$	$h_{max.}$	$b_{max.}$	r	$l_{max.}$	$h_{max.}$	$b_{max.}$	r	$l_{max.}$	$h_{max.}$	$b_{max.}$	r	$l_{max.}$	$h_{max.}$	$b_{max.}$	r											
	(mm)				(mm)				(mm)				(mm)				(mm)				(mm)														
0,022																									32	17	9	27,5							
0,027																													32	17	11	27,5			
0,033																																32	17	9	27,5
0,039																																32	17	9	27,5
0,047																																32	20	11	27,5
0,056																																32	21	12	27,5
0,068																																32	22	13	27,5
0,082																																32	24,5	15	27,5
0,1																																32	26,5	17	27,5
0,12																																32	28	18	27,5
0,15																																32	20	11	27,5
0,18																																32	22	13	27,5
0,22																																32	23,5	14	27,5
0,27																																32	24,5	15	27,5
0,33																																32	26,5	17	27,5
0,39																																32	28	18	27,5
0,47																																32	28	18	27,5
0,56																																32	17	9	27,5
0,68																																32	17	11	27,5
0,82																																32	20	11	27,5
1																																32	22	13	27,5
1,2																																32	23,5	14	27,5
1,5																																32	24,5	15	27,5
1,8																																32	26,5	17	27,5
2,2																																32	28	18	27,5

Capacitors

Type KNU

Metallized polypropylene capacitors

As a dielectric a high quality polypropylene film of excellent electrical properties is used. Electrodes are of vacuum evaporated metal on dielectric. Leads are electrically welded on

contact surface of capacitors. So the possibility for bad contact or even loss of contact during the operation of capacitors is excluded.

Typical electrical characteristics of metallized polypropylene capacitors KNU

Variation of capacitance as a function of temperature

$$\frac{\Delta C}{C} = f(\vartheta) \text{ at } 1 \text{ kHz}$$

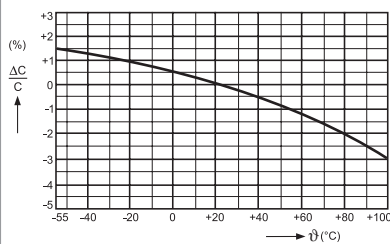

Variation of dissipation factor (tanδ) as a function of frequency

$$\tan \delta = f(f)$$

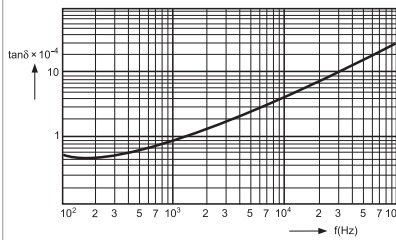

Variation of dissipation factor (tanδ) as a function of temperature

$$\tan \delta = f(\vartheta) \text{ at } 1 \text{ kHz}$$

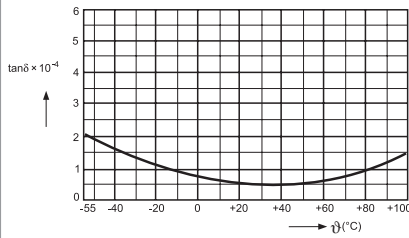

Variation of insulation resistance as a function of temperature

$$R_i = f(\vartheta)$$

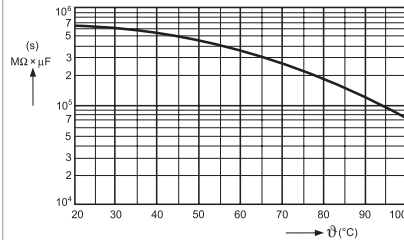

Variation of capacitance as a function of frequency

$$\frac{\Delta C}{C} = f(f)$$

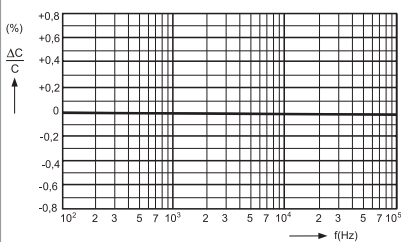

Capacitors

Type KNU 1910

radial leads, pitch 10 mm to 27,5 mm

TECHNICAL DATA

General technical data

Dielectric:	polypropylene film
Electrodes:	vacuum metallized on dielectric
Winding:	non-inductive construction, flat shape
Leads:	tinned copper wire, standard lengths l_1 : $4^{\pm 0,5}$; 6^{-1} ; $25^{\pm 5}$. Other lead lengths on request.
Encapsulation:	flame-retardant plastic case with flame-retardant epoxy resin seal, UL 94 V-0, resistant to wash in halogenated solvents
Marking:	Iskra symbol, capacitance, tolerance, rated voltage, type designation
Climatic category:	55/100/56 IEC 60068-1
Temperature range:	- 55 °C to + 100 °C
Complies with standards:	IEC 60384-16

Electrical data

Capacitance range:	1000 pF to 6,8 μ F
Standard values of capacitance (C_R):	range E6
Capacitance tolerance:	$\pm 20\%$ (M); $\pm 10\%$ (K) and $\pm 5\%$ (J) on special request
Temperature coefficient of capacitance (T_C):	appr. $- 200 \times 10^{-6} / ^\circ\text{C}$
Rated voltage (U_R):	250 V DC, 400 V DC, 630 V DC, 1000 V DC, 1600 V DC
Allowed alternative voltage up to 60 Hz:	160 V AC, 220 V AC, 250 V AC, 300 V AC, 500 V AC
Category voltage (U_C):	up to + 85 °C $U_C = U_R$; from + 85 °C to + 100 °C voltage U_R is lowered for 1,35 % per 1 °C
Test voltage:	$1,6 \times U_R$, 2 s
Insulation resistance (R_i) at 20 °C:	$\geq 100000 \text{ M}\Omega$ at 20 °C for $C_R \leq 0,33 \mu\text{F}$ $R_i \times C_R \geq 30000 \text{ s}$ at 20 °C for $C_R > 0,33 \mu\text{F}$
Self inductance:	appr. 10 nH/cm length of capacitor and leads
Soldering on printed circuit boards:	temperature of soldering bath 270 °C max., soldering time 5 s max.

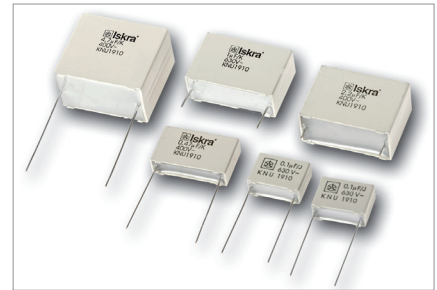

KNU1910 (dimensions in mm)

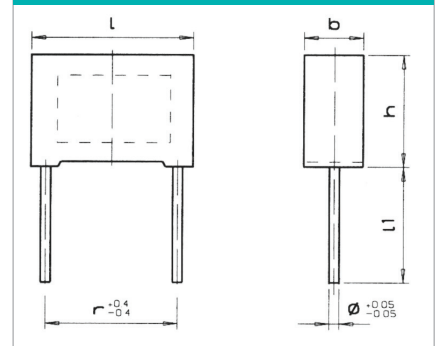

Diameter of leads:

r (mm)	ϕ (mm)
10	0,6
15; 22,5; 27,5	0,8

Pulse loading (du/dt):

U_R (V DC)	Pitch r (mm)			
	10	15	22,5	27,5
	Allowed pulse loading (V/ μ s)			
250	180	120	60	45
400	200	150	90	65
630	230	180	120	90
1000	-	210	130	100
1600	-	450	190	140

Dissipation factor (tan δ):

f (kHz)	$C_R \leq 0,1 \mu F$	$0,1 \mu F < C_R \leq 1 \mu F$	$C_R > 1 \mu F$
1	$\leq 5 \times 10^{-4}$	$\leq 5 \times 10^{-4}$	$\leq 5 \times 10^{-4}$
10	$\leq 10 \times 10^{-4}$	$\leq 20 \times 10^{-4}$	-
100	$\leq 30 \times 10^{-4}$	-	-

Dimensional data: KNU1910

Capacitance (μF)	Rated voltage U_R																			
	250 V DC				400 V DC				630 V DC				1000 V DC				1600 V DC			
	$l_{max.}$	$h_{max.}$	$b_{max.}$	r	$l_{max.}$	$h_{max.}$	$b_{max.}$	r	$l_{max.}$	$h_{max.}$	$b_{max.}$	r	$l_{max.}$	$h_{max.}$	$b_{max.}$	r	$l_{max.}$	$h_{max.}$	$b_{max.}$	r
	(mm)				(mm)				(mm)				(mm)				(mm)			
0,001																	18	11	5	15
0,0015																	18	11	5	15
0,0022																	18	11	5	15
0,0033																	18	11	5	15
0,0047									13	9	4	10					18	11	5	15
0,0068									13	9	4	10					18	11	5	15
0,01					13	9	4	10	13	9	4	10	18	11	5	15	18	11	5,5	15
0,015					13	9	4	10	13	9,5	4,3	10	18	11	5	15	18	13	7	15
0,022	13	9	4	10	13	9	4	10	13	10,5	5	10	18	11	5	15	18	14,5	8,5	15
0,033	13	9	4	10	13	9,5	4,3	10	13	11,5	6	10	18	11	5,5	15	26,5	15	6	22,5
0,047	13	9	4	10	13	10,5	5	10	18	11	5	15	18	13	7	15	26,5	16	7	22,5
0,068	13	9,5	4,3	10	13	11,5	6	10	18	11	5,5	15	18	13,5	7,5	15	26,5	18,5	9	22,5
0,1	13	10,5	5	10	18	11	5	15	18	13	7	15	26,5	15	6	22,5	26,5	20,5	11	22,5
0,15	13	11,5	6	10	18	11	5,5	15	18	14,5	8,5	15	26,5	16,5	7,5	22,5	31,5	21	12	27,5
0,22	18	11	5	15	18	13	7	15	26,5	15	6	22,5	26,5	18,5	9	22,5	31,5	23,5	14	27,5
0,33	18	12	6	15	18	14,5	8,5	15	26,5	16,5	7,5	22,5	31,5	19	10	27,5	31,5	26,5	17	27,5
0,47	18	13	7	15	26,5	16	7	22,5	26,5	18,5	9	22,5	31,5	21	12	27,5				
0,68	18	14,5	9	15	26,5	17	8,5	22,5	26,5	20,5	11	22,5	31,5	23,5	14	27,5				
1	26,5	15	6	22,5	26,5	18,5	10	22,5	31,5	21	12	27,5	31,5	26,5	17	27,5				
1,5	26,5	17	8,5	22,5	31,5	19	10	27,5												
2,2	26,5	20,5	11	22,5	31,5	23,5	14	27,5												
3,3	31,5	21	12	27,5																
4,7	31,5	23,5	14	27,5																
6,8	31,5	26,5	17	27,5																

Taped version details data see page 11



Iskra, d. d.

Headquarters

Stegne 21, SI-1000

Ljubljana, Slovenia

Tel.: +386 1 513 00 00

Fax: +386 1 511 15 32

E-mail: iskra@iskra.eu

<http://www.iskra.eu>

