

# MULTILAYER (MONO) CERAMIC CAPACITOR

Suntan®

# TS17

## FEATURES

- Miniature size, wide capacitance, tape and reel packaging available for auto-placement.
- Coating by epoxy resin, creates the excellent humidity resistance and prevents body from damaging during soldering and washing.
- Industry standard size and various load spacing available.

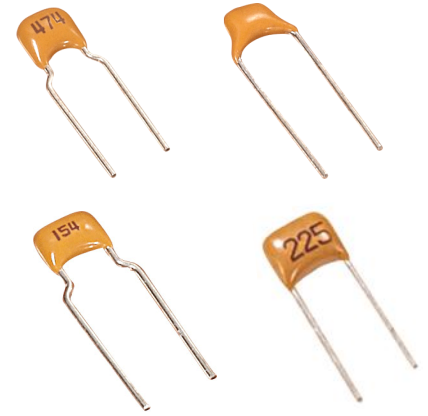

S	P	E	C	I	F	I	C	A	T	I	O	N	S
T.C	NPO/COG			X7R(B)			Y5V(Y/F)			Z5U(E)			
Dielectric type	Stable Class I Dielectric			Stable Class II Dielectric									
Electrical properties	With negligible dependence of electrical properties on temperature, voltage, frequency and time			With predictable change of properties with temperature, voltage, frequency and time, this dielectric is ferroelectric and offers higher capacitance ranges than Class I.			With high twist dielectric constant and greater variation of properties with temperature and test conditions, very high capacitance per unit volume.						
Application	Use in circuits requiring stable performance			Use as blocking, coupling, By-passing discriminating element.			Suited for By-passing and coupling application such as store power and memory circuit						
Capacitance range	1pF~10nF			100pF~5uF			1nF~14.7uF						
Operating temperature	0±30PPm/c -55°C~+125°C			±15% -55°C~+125°C			+30%~-80% -25°C~+85°C			+22%~-56% -10°C~+85°C			

# TS17

Capacitance Change VS Temperature Characteristic ; Voltage ; Frequency Profiles

◆ NPO

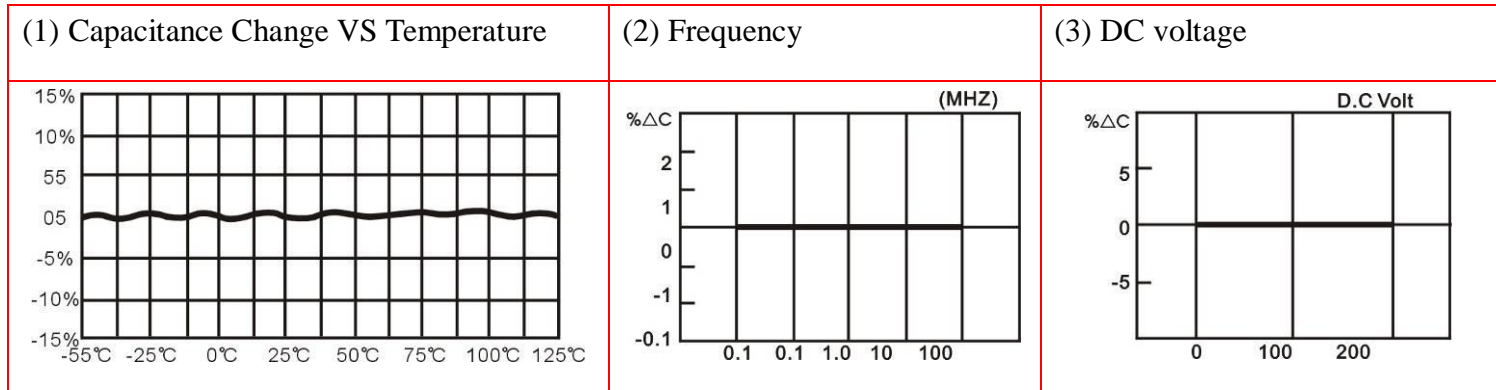

◆ X7R

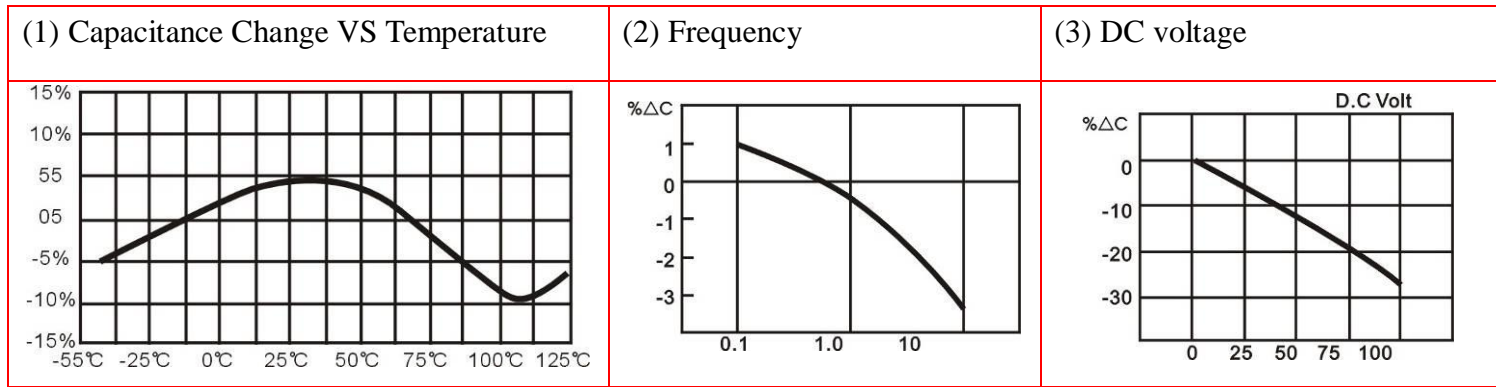

◆ Z5U

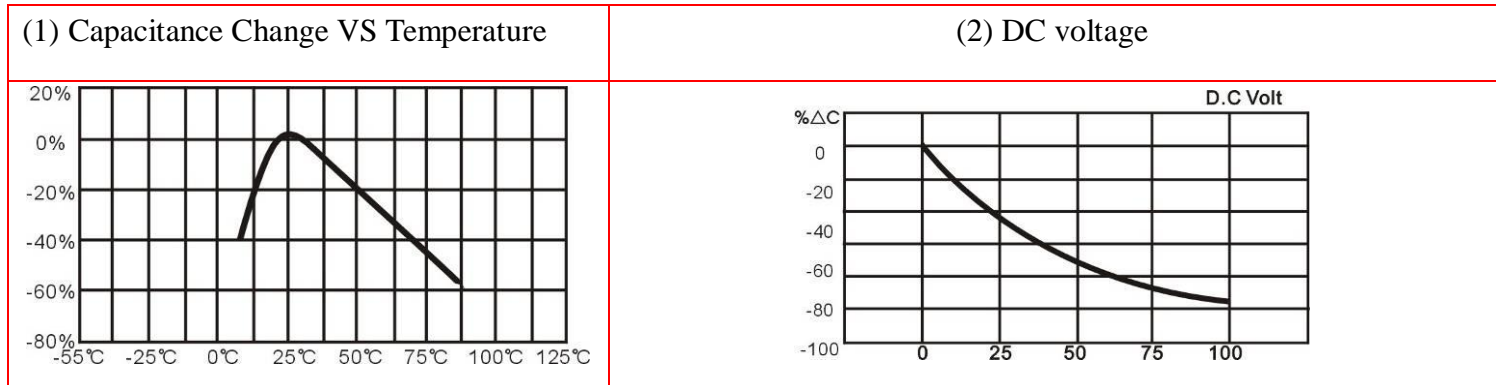

# TS17

Leads MLCC(Radial、Axial)

◆ Electrical Properties standard

Item	Test standard			
	NPO/CG/GH/RH/UJ/SL	X7R(B)	Z5U(E)	Y5V(Y/F)
Capacitance	± 5%	± 10%	+80-20%	± 20%
Dissipation Factor	<0.15%	<3.5%	<5%	<7.5%(200nF)
				<10% (220~470nF)
				<15%(470~1000nF)
Insulation Resistance	<10nF	<25nF	<25nF	<25nF
	IR<1000C0M Ω	IR>25nF	IR>25nF	IR>25nF
	C>10nF	C>25Nf	C>25Nf	C>25Nf
	R· C>100S	R· C>100S	R· C>100S	R· C>100S
Withstanding Voltage	2.5 rated voltage	2.5 rated voltage	2.5 rated voltage	2.5 rated voltage
Test Condition				
Test Frequency	1 MHZ (C>1000PF 1KHz)	1KHz	1KHz	1KHz
Test Voltage of Cap.&D.F	1 ± 0.2V	1 ± 0.2V	0.3 ± 0.2V	0.3 ± 0.2V
Test Voltage of IR	Rated Voltage	Rated Voltage	Rated Voltage	Rated Voltage
Temperature	10~25℃	10~25℃	10~25℃	10~25℃
Humidity	<75%	<75%	<75%	<75%

# TS17

Leads MLCC(Radial、 Axial)

◆ Quality Item & Reliability inspection

Item	Test Specifications		Test Methods																													
Solderability	Termination area shall be at least 75% covered with a new solder coating.		The lead wire of a capacitor shall be dipped into a 25% methanol solution of rosin and then into molten solder at 235°C for 2 ± 0.5 seconds, in both cases the depth of dipping is up to about 2.5 to 3.0mm from the root of lead.																													
Resistance to soldering heat	There shall be no evidence of damage or flash over during the test and sign in focus.		The lead wire shall be immersed into the melted solder of 260°C ± 5°C up to about 2.5 to 3.0mm from the main body for 5 ± 0.5sec and the specified items shall be measured after leaving for 24 ± 2 hours																													
	T.C	$\Delta C/C <$																														
	CG/CH/RH	0.5% or 0.5Pf																														
	UJ/SL	1% or 1pF																														
	B	± 10%																														
	Y(F)/E	± 20%																														
Life test	Appearance	There shall be no evidence of damage or flash over during the test and sign in focus	<table border="1"> <thead> <tr> <th>Condition</th> <th>NPO</th> <th>X7R</th> <th>Y5V</th> <th>Z5U</th> </tr> </thead> <tbody> <tr> <td>Temperature</td> <td colspan="2">+125°C</td> <td colspan="2">+85°C</td> </tr> <tr> <td>Time</td> <td colspan="4">T=1000h</td> </tr> <tr> <td>Voltage</td> <td colspan="4">V=1.5Vr</td> </tr> <tr> <td>Recovery time</td> <td colspan="4">24 ± 1h</td> </tr> </tbody> </table>					Condition	NPO	X7R	Y5V	Z5U	Temperature	+125°C		+85°C		Time	T=1000h				Voltage	V=1.5Vr				Recovery time	24 ± 1h			
			Condition	NPO	X7R	Y5V	Z5U																									
	Temperature	+125°C		+85°C																												
	Time	T=1000h																														
	Voltage	V=1.5Vr																														
Recovery time	24 ± 1h																															
Capacitance change	NPO: <2%; X7R <20%; Y5V: <30%																															
D.F	NPO: <0.3 X7R: <5% Y5V: <7%																															
I.R	R.C <258																															

# TS17

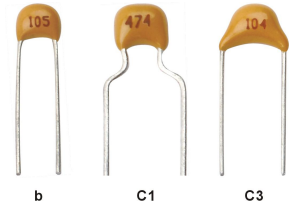

Leads MLCC(Radial, Axial)

◆ Size Code, Capacitance and Voltage

Size code	shape	Dimensions(mm)				Voltage	Capacitance(PF)		
		P(±0.5)	Lmax	Wmax	Tmax		COG(NPO)	X7R	Y5V(Z5U)
0805	b	2.54	4.2	3.8	3.0	25V 50V 100V	OR5~103	101~105	103~475
	C1	5.08							
	C3	5.08	4.2	5.0	3.0				
1206	a	2.54				25V 50V 100V	OR5~104	101~225	103~106
	b	3.5	5.0	4.5	3.5				
	C1	5.08							
1210	a	2.54				25V 50V 100V	OR5~104	101~106	103~106
	b	3.5	5.0	4.5	3.5				
	C1	5.08							
1812	b	5.08	7.0	6.0	4.0	25V 50V 100V	OR5~104	101~106	103~106
2225	b	5.5	10	9	4.5	25V 50V 100V	OR5~104	101~106	103~106
3035	b	7.5	12	10	4.5	25V 50V 100V	OR5~104	101~106	103~106

\*Notice 1: Normail length of lead is 10.0mm(± 1)& it can be adjusted between 3.0~25mm by customer request.

Notice 2: The diameter of lead is  $\phi 0.5 \pm 0.05$ mm

# TS17

Radial Leads MLCC

◆ Packaging Style

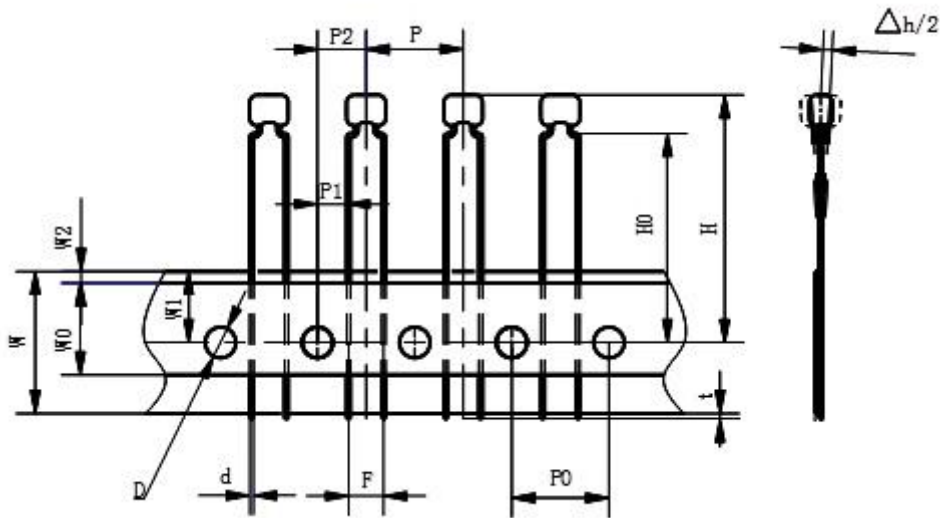

Note: P1=3.85mm for F=5.08mm P1=5.1mm for F=2.54mm

Code	P	P0	P1	P2	d	Δh	w	W0	W1	W2	H	H0	D	t
Dim	12.7	12.7	3.85 5.1	6.35	0.5	0	18.5	12	9	1.5	25	15~20	4.0	0.7
Tol	± 0.2	± 0.2	0.7	± 1.3	± 0.1	± 2	± 1	± 1	± 0.5	± 1.5	Max	± 0.5	± 0.2	Max

\* Ammo packaging

\* Reel packaging

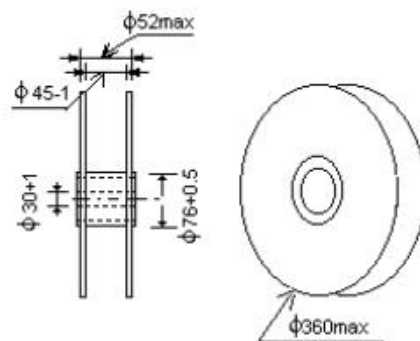

# TS17

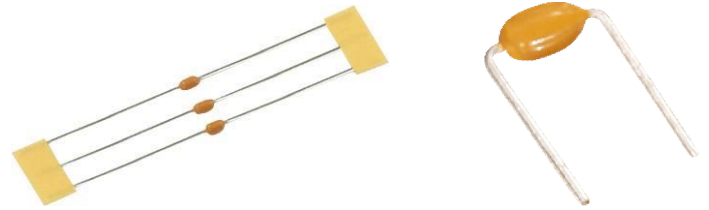

## Axial Laser MLCC

### ◆ Size Code、Capacitance and Voltage

Size code	Dimensions(mm)				voltage e	Capacitance ranges			
	L max	D max	F (±0.6)			d (±0.05)	COG (NPO)	X7R	Y5V (Z5U)
15	3.8	2.5	5.08	10.0	0.45	25V	OR5~102	101~333	222~224
						50V	OR5~821	101~223	222~154
						100V	OR5~561	101~472	
16	5.08	2.5	5.08	10.0	0.45	25V	OR5~332	331~104	103~105
						50V	OR5~222	331~473	103~684
						100V	OR5~102	331~223	
17	4.30	2.5	5.08	10.0	0.45	25V	OR5~332	331~104	103~105
						50V	OR5~222	331~473	103~684
						100V	OR5~102	331~223	
19	7.50	3.0	7.50	10.0	0.45	25V	OR5~472	102~224	103~125
						50V	OR5~392	102~104	103~105
						100V	OR5~152	102~683	
20	5.10	3.0	7.50	10.0	0.45	25V	OR5~472	102~224	103~125
						50V	OR5~392	102~104	103~105
						100V	OR5~152	102~683	

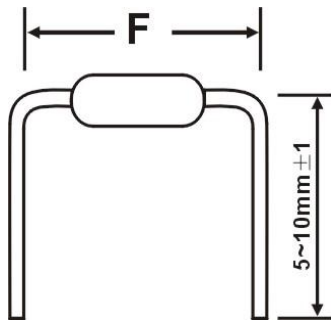
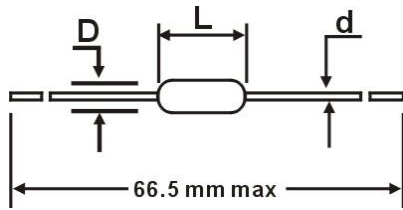

### ◆ Packaging style

#### Tape and reel

Tape style	A	B
Tape width:26mm	26 ± 1.5mm	13 ± 0.76mm
Tape width:52.4mm	52.4 ± 1.5mm	26.2 ± 0.76mm

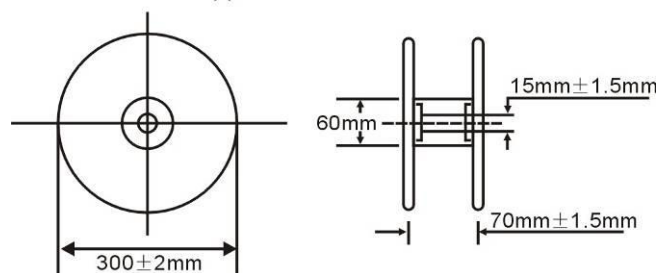
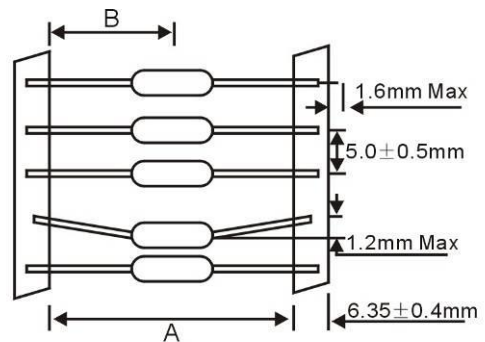

# TS17

**Ammo package**

Tape style	A	B	C	D
52.4mm	81(± 5)mm	72(± 5)mm	258(± 5)mm	Lable
26mm	50(± 5)mm	110(± 5)mm	258(± 5)mm	

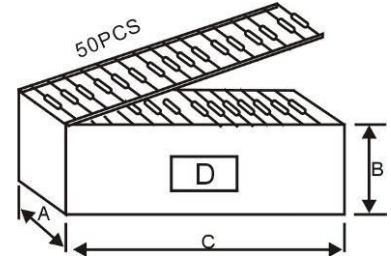

**Packaging quantity**

Size code	Tape and reel	Ammo package	Bulk package
15	5000	5000	1000(500)
16	5000	5000	1000(500)
17	5000	5000	1000(500)
19	2500(5000)	2500(5000)	500
20	2500(5000)	2500	500

\*packaging according to the customer's requirement