

MM74HC244 Octal 3-STATE Buffer

General Description

The MM74HC244 is a non-inverting buffer and has two active low enables (1G and 2G); each enable independently controls 4 buffers. This device does not have Schmitt trigger inputs.

These 3-STATE buffers utilize advanced silicon-gate CMOS technology and are general purpose high speed non-inverting buffers. They possess high drive current outputs which enable high speed operation even when driving large bus capacitances. These circuits achieve speeds comparable to low power Schottky devices, while retaining the advantage of CMOS circuitry, i.e., high noise immunity, and low power consumption. All three devices have a fanout of 15 LS-TTL equivalent inputs.

All inputs are protected from damage due to static discharge by diodes to V_{CC} and ground.

Features

- Typical propagation delay: 14 ns
- 3-STATE outputs for connection to system buses
- Wide power supply range: 2–6V
- Low quiescent supply current: 80 μ A
- Output current: 6 mA

Ordering Code:

Order Number	Package Number	Package Description
MM74HC244WM	M20B	20-Lead Small Outline Integrated Circuit (SOIC), JEDEC MS-013, 0.300" Wide
MM74HC244SJ	M20D	20-Lead Small Outline Package (SOP), EIAJ TYPE II, 5.3mm Wide
MM74HC244MTC	MTC20	20-Lead Thin Shrink Small Outline Package (TSSOP), JEDEC MO-153, 4.4mm Wide
MM74HC244N	N20A	20-Lead Plastic Dual-In-Line Package (PDIP), JEDEC MS-001, 0.300" Wide

Devices also available in Tape and Reel. Specify by appending the suffix letter "X" to the ordering code.

Connection Diagram

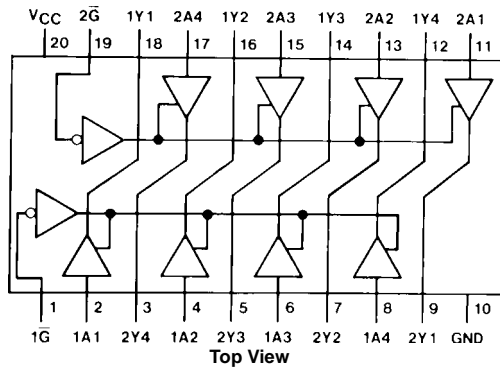

Truth Table

$\overline{1G}$	1A	1Y	$\overline{2G}$	2A	2Y
L	L	L	L	L	L
L	H	H	L	H	H
H	L	Z	H	L	Z
H	H	Z	H	H	Z

H = HIGH Level
L = LOW Level
Z = High Impedance

Logic Diagram

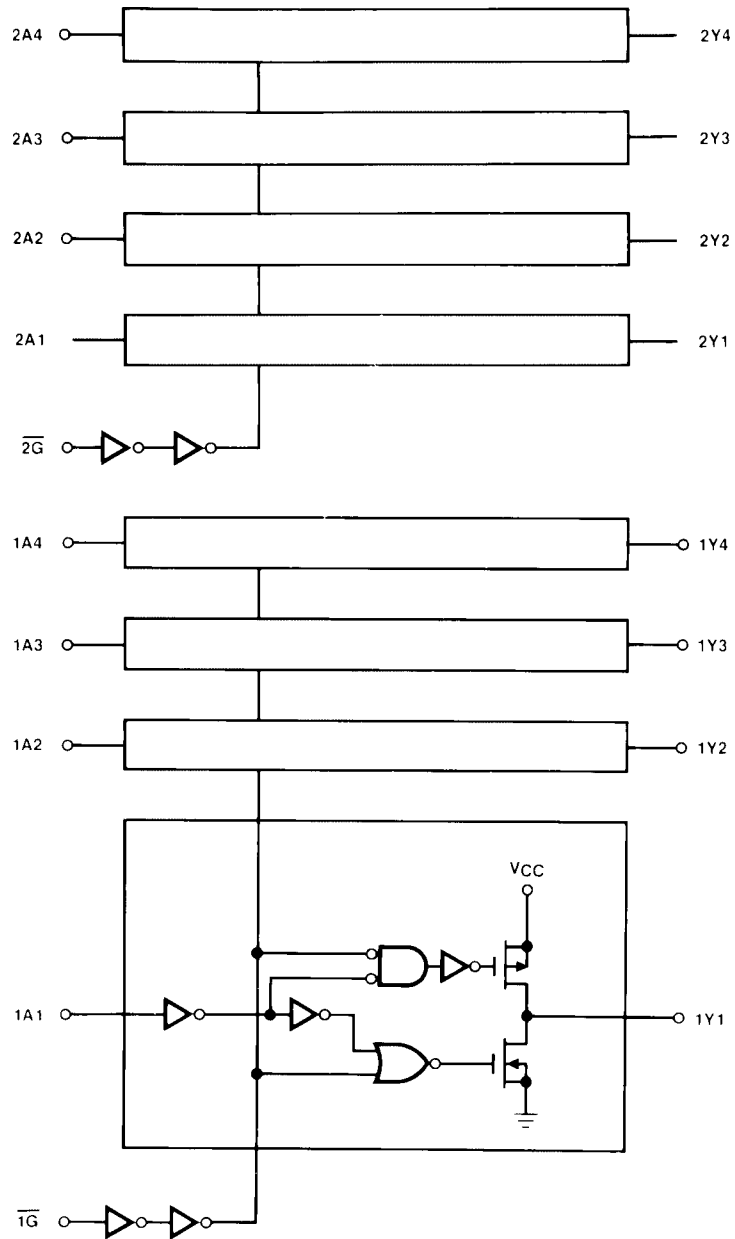

Absolute Maximum Ratings (Note 1)

(Note 2)

Supply Voltage (V_{CC})	-0.5 to +7.0V
DC Input Voltage (V_{IN})	-1.5 to $V_{CC} + 1.5V$
DC Output Voltage (V_{OUT})	-0.5 to $V_{CC} + 0.5V$
Clamp Diode Current (I_{IK}, I_{OK})	± 20 mA
DC Output Current, per pin (I_{OUT})	± 35 mA
DC V_{CC} or GND Current, per pin (I_{CC})	± 70 mA
Storage Temperature Range (T_{STG})	-65°C to +150°C
Power Dissipation (P_D)	
(Note 3)	600 mW
S.O. Package only	500 mW
Lead Temperature (T_L)	
(Soldering 10 seconds)	260°C

Recommended Operating Conditions

	Min	Max	Units
Supply Voltage (V_{CC})	2	6	V
DC Input or Output Voltage			
(V_{IN}, V_{OUT})	0	V_{CC}	V
Operating Temperature Range (T_A)	-40	+85	°C
Input Rise or Fall Times			
(t_r, t_f) $V_{CC} = 2.0V$		1000	ns
$V_{CC} = 4.5V$		500	ns
$V_{CC} = 6.0V$		400	ns

Note 1: Absolute Maximum Ratings are those values beyond which damage to the device may occur.

Note 2: Unless otherwise specified all voltages are referenced to ground.

Note 3: Power Dissipation temperature derating — plastic "N" package: -12 mW/°C from 65°C to 85°C.

DC Electrical Characteristics (Note 4)

Symbol	Parameter	Conditions	V_{CC}	$T_A = 25^\circ\text{C}$			Units	
				Typ	Guaranteed Limits			
V_{IH}	Minimum HIGH Level Input Voltage		2.0V		1.5	1.5	1.5	V
			4.5V		3.15	3.15	3.15	V
			6.0V		4.2	4.2	4.2	V
V_{IL}	Maximum LOW Level Input Voltage		2.0V		0.5	0.5	0.5	V
			4.5V		1.35	1.35	1.35	V
			6.0V		1.8	1.8	1.8	V
V_{OH}	Minimum HIGH Level Output Voltage	$V_{IN} = V_{IH}$ or V_{IL} $ I_{OUT} \leq 20 \mu\text{A}$	2.0V	2.0	1.9	1.9	1.9	V
			4.5V	4.5	4.4	4.4	4.4	V
			6.0V	6.0	5.9	5.9	5.9	V
		$V_{IN} = V_{IH}$ or V_{IL} $ I_{OUT} \leq 6.0$ mA $ I_{OUT} \leq 7.8$ mA	4.5V	4.2	3.98	3.84	3.7	V
			6.0V	5.7	5.4	5.34	5.2	V
								V
V_{OL}	Maximum LOW Level Output Voltage	$V_{IN} = V_{IH}$ or V_{IL} $ I_{OUT} \leq 20 \mu\text{A}$	2.0V	0	0.1	0.1	0.1	V
			4.5V	0	0.1	0.1	0.1	V
			6.0V	0	0.1	0.1	0.1	V
		$V_{IN} = V_{IH}$ or V_{IL} $ I_{OUT} \leq 6.0$ mA $ I_{OUT} \leq 7.8$ mA	4.5V	0.2	0.26	0.33	0.4	V
			6.0V	0.2	0.26	0.33	0.4	V
								V
I_{IN}	Maximum Input Current	$V_{IN} = V_{CC}$ or GND	6.0V		± 0.1	± 1.0	± 1.0	μA
I_{OZ}	Maximum 3-STATE Output Leakage Current	$V_{IN} = V_{IH}$, or V_{IL} $V_{OUT} = V_{CC}$ or GND $\bar{G} = V_{IH}$	6.0V		± 0.5	± 5	± 10	μA
I_{CC}	Maximum Quiescent Supply Current	$V_{IN} = V_{CC}$ or GND $I_{OUT} = 0 \mu\text{A}$	6.0V		8.0	80	160	μA

Note 4: For a power supply of $5V \pm 10\%$ the worst case output voltages (V_{OH} , and V_{OL}) occur for HC at 4.5V. Thus the 4.5V values should be used when designing with this supply. Worst case V_{IH} and V_{IL} occur at $V_{CC} = 5.5V$ and 4.5V respectively. (The V_{IH} value at 5.5V is 3.85V.) The worst case leakage current (I_{IN} , I_{CC} , and I_{OZ}) occur for CMOS at the higher voltage and so the 6.0V values should be used.

AC Electrical Characteristics								
$V_{CC} = 5V, T_A = 25^{\circ}C, t_r = t_f = 6 \text{ ns}$								
Symbol	Parameter	Conditions	Typ	Guaranteed Limit	Units			
t_{PHL}, t_{PLH}	Maximum Propagation Delay	$C_L = 45 \text{ pF}$	14	20	ns			
t_{PZH}, t_{PZL}	Maximum Enable Delay to Active Output	$R_L = 1 \text{ k}\Omega$ $C_L = 45 \text{ pF}$	17	28	ns			
t_{PHZ}, t_{PLZ}	Maximum Disable Delay from Active Output	$R_L = 1 \text{ k}\Omega$ $C_L = 5 \text{ pF}$	15	25	ns			
AC Electrical Characteristics								
$V_{CC} = 2.0V-6.0V, C_L = 50 \text{ pF}, t_r = t_f = 6 \text{ ns}$ (unless otherwise specified)								
Symbol	Parameter	Conditions	V_{CC}	$T_A = 25^{\circ}C$		$T_A = -40 \text{ to } 85^{\circ}C$	$T_A = -55 \text{ to } 125^{\circ}C$	Units
				Typ	Guaranteed Limits			
t_{PHL}, t_{PLH}	Maximum Propagation Delay	$C_L = 50 \text{ pF}$	2.0V	58	115	145	171	ns
			2.0V	83	165	208	246	ns
		$C_L = 150 \text{ pF}$	4.5V	14	23	29	34	ns
			4.5V	17	33	42	49	ns
		6.0V	10	20	25	29	ns	
t_{PZH}, t_{PZL}	Maximum Output Enable Time	$R_L = 1 \text{ k}\Omega$	2.0V	75	150	189	224	ns
		$C_L = 150 \text{ pF}$	4.5V	15	30	38	45	ns
			4.5V	30	40	50	60	ns
		6.0V	13	26	32	38	ns	
6.0V	17	34	43	51	ns			
t_{PHZ}, t_{PLZ}	Maximum Output Disable Time	$R_L = 1 \text{ k}\Omega$ $C_L = 50 \text{ pF}$	2.0V	75	150	189	224	ns
			4.5V	15	30	38	45	ns
			6.0V	13	26	32	38	ns
t_{TLH}, t_{THL}	Maximum Output Rise and Fall Time		2.0V		60	75	90	ns
			4.5V		12	15	18	ns
			6.0V		10	13	15	ns
C_{PD}	Power Dissipation Capacitance (Note 5)	(per buffer) $\overline{G} = V_{IH}$ $\overline{G} = V_{IL}$		12				pF
				50				pF
C_{IN}	Maximum Input Capacitance			5	10	10	10	pF
C_{OUT}	Maximum Output Capacitance			10	20	20	20	pF
<p>Note 5: C_{PD} determines the no load dynamic power consumption, $P_D = C_{PD} V_{CC}^2 f + I_{CC} V_{CC}$, and the no load dynamic current consumption, $I_S = C_{PD} V_{CC} f + I_{CC}$.</p>								

Physical Dimensions inches (millimeters) unless otherwise noted



**20-Lead Small Outline Integrated Circuit (SOIC), JEDEC MS-013, 0.300" Wide
Package Number M20B**

Physical Dimensions inches (millimeters) unless otherwise noted (Continued)



LAND PATTERN RECOMMENDATION

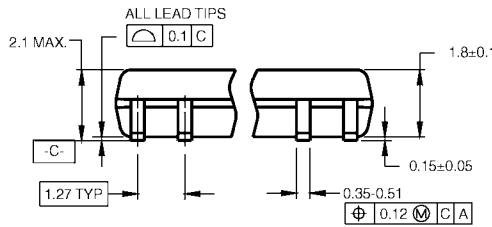

DIMENSIONS ARE IN MILLIMETERS



DETAIL A

NOTES:

- A. CONFORMS TO EIAJ EDR-7320 REGISTRATION, ESTABLISHED IN DECEMBER, 1998.
- B. DIMENSIONS ARE IN MILLIMETERS.
- C. DIMENSIONS ARE EXCLUSIVE OF BURRS, MOLD FLASH, AND TIE BAR EXTRUSIONS.

M20DRevB1

20-Lead Small Outline Package (SOP), EIAJ TYPE II, 5.3mm Wide Package Number M20D

Physical Dimensions inches (millimeters) unless otherwise noted (Continued)

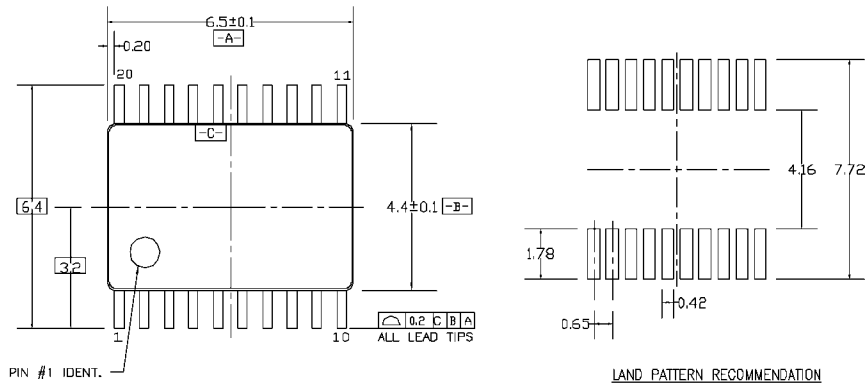

PIN #1 IDENT.

LAND PATTERN RECOMMENDATION

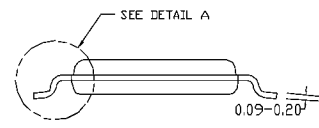
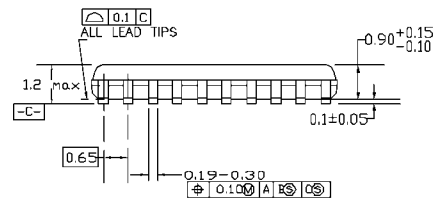

DIMENSIONS ARE IN MILLIMETERS

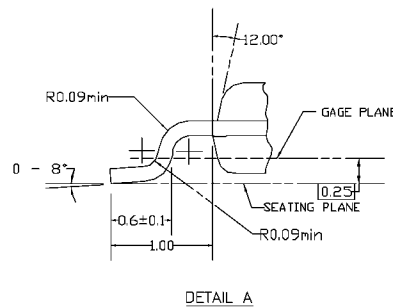

- NOTES:
- A. CONFORMS TO JEDEC REGISTRATION MO-153, VARIATION AC, REF NOTE 6, DATE 7/93.
 - B. DIMENSIONS ARE IN MILLIMETERS.
 - C. DIMENSIONS ARE EXCLUSIVE OF BURRS, MOLDS FLASH, AND TIE BAR EXTRUSIONS.
 - D. DIMENSIONS AND TOLERANCES PER ANSI Y14.5M, 1982.

MTC20REVD1

20-Lead Thin Shrink Small Outline Package (TSSOP), JEDEC MO-153, 4.4mm Wide Package Number MTC20

Physical Dimensions inches (millimeters) unless otherwise noted (Continued)

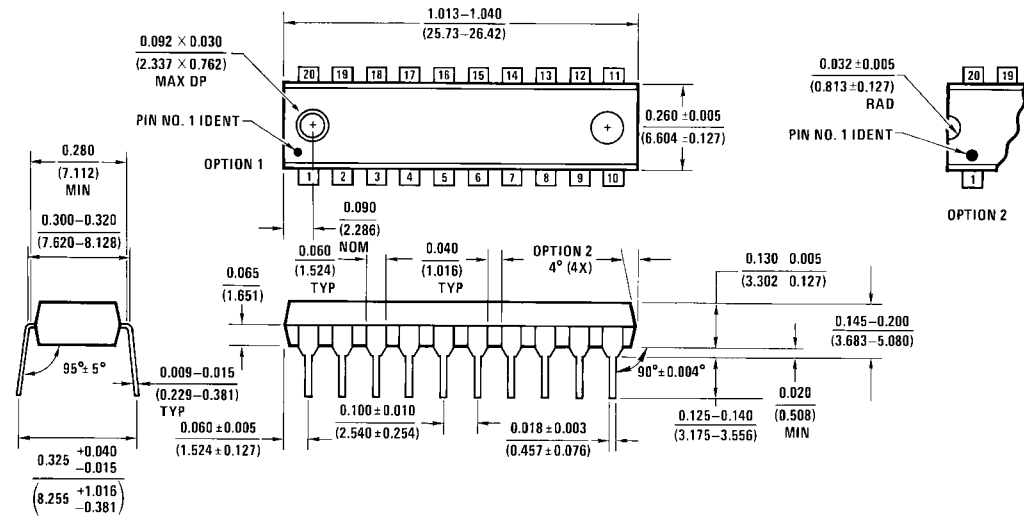

N20A (REV G)

**20-Lead Plastic Dual-In-Line Package (PDIP), JEDEC MS-001, 0.300" Wide
Package Number N20A**

Fairchild does not assume any responsibility for use of any circuitry described, no circuit patent licenses are implied and Fairchild reserves the right at any time without notice to change said circuitry and specifications.

LIFE SUPPORT POLICY

FAIRCHILD'S PRODUCTS ARE NOT AUTHORIZED FOR USE AS CRITICAL COMPONENTS IN LIFE SUPPORT DEVICES OR SYSTEMS WITHOUT THE EXPRESS WRITTEN APPROVAL OF THE PRESIDENT OF FAIRCHILD SEMICONDUCTOR CORPORATION. As used herein:

1. Life support devices or systems are devices or systems which, (a) are intended for surgical implant into the body, or (b) support or sustain life, and (c) whose failure to perform when properly used in accordance with instructions for use provided in the labeling, can be reasonably expected to result in a significant injury to the user.
2. A critical component in any component of a life support device or system whose failure to perform can be reasonably expected to cause the failure of the life support device or system, or to affect its safety or effectiveness.

www.fairchildsemi.com