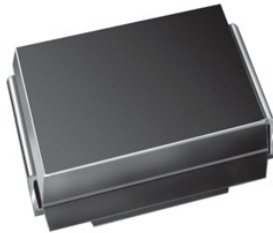

Surface Mount TRANSZORB® Transient Voltage Suppressors

DO-214AA (SMB J-Bend)

PRIMARY CHARACTERISTICS	
V_{WM}	5.80 V to 188 V
V_{BR} uni-directional	6.8 V to 220 V
V_{BR} bi-directional	6.8 V to 220 V
P_{PPM}	600 W
P_D	5.0 W
I_{FSM} (uni-directional only)	100 A
T_J max.	150 °C
Polarity	Uni-directional, bi-directional
Package	DO-214AA (SMB J-Bend)

DEVICES FOR BI-DIRECTION APPLICATIONS

For bi-directional devices use CA suffix (e.g. SM6T12CA).

Electrical characteristics apply in both directions.

FEATURES

- Low profile package
- Ideal for automated placement
- Glass passivated chip junction
- Available in uni-directional and bi-directional
- 600 W peak pulse power capability with a 10/1000 μ s waveform
- Excellent clamping capability
- Low inductance
- Meets MSL level 1, per J-STD-020, LF maximum peak of 260 °C
- AEC-Q101 qualified
- Material categorization: for definitions of compliance please see www.vishay.com/doc?99912

RoHS
COMPLIANT

TYPICAL APPLICATIONS

Use in sensitive electronics protection against voltage transients induced by inductive load switching and lighting on ICs, MOSFET, signal lines of sensor units for consumer, computer, industrial, automotive, and telecommunication.

MECHANICAL DATA

Case: DO-214AA (SMB J-Bend)

Molding compound meets UL 94 V-0 flammability rating
Base P/N-E3 - RoHS-compliant and industrial grade
Base P/NHE3 - RoHS-compliant and AEC-Q101 qualified

Terminals: Matte tin plated leads, solderable per J-STD-002 and JESD 22-B102

E3 suffix meets JESD 201 class 2 whisker test, HE3 suffix meets JESD 201 class 2 whisker test

Polarity: For uni-directional types the band denotes cathode end, no marking on bi-directional types

MAXIMUM RATINGS ($T_A = 25$ °C unless otherwise noted)			
PARAMETER	SYMBOL	VALUE	UNIT
Peak power dissipation with a 10/1000 μ s waveform ⁽¹⁾⁽²⁾ (fig. 1)	P_{PPM}	600	W
Peak pulse current with a 10/1000 μ s waveform ⁽¹⁾ (fig. 3)	I_{PPM}	See next table	A
Power dissipation on infinite heatsink at $T_A = 50$ °C	P_D	5.0	W
Peak forward surge current 10 ms single half sine-wave uni-directional only ⁽²⁾	I_{FSM}	100	A
Operating junction and storage temperature range	T_J, T_{STG}	-65 to +150	°C

Notes

⁽¹⁾ Non-repetitive current pulse, per fig. 3 and derated above $T_A = 25$ °C per fig. 2.

⁽²⁾ Mounted on 0.2" x 0.2" (5.0 mm x 5.0 mm) copper pads to each terminal



ELECTRICAL CHARACTERISTICS ($T_A = 25\text{ }^\circ\text{C}$ unless otherwise noted)												
TYPE ⁽¹⁾	DEVICE MARKING CODE		BREAKDOWN VOLTAGE V_{BR} AT I_T ⁽²⁾ (V)		TEST CURRENT I_T (mA)	STAND-OFF VOLTAGE V_{RM} (V)	LEAKAGE CURRENT I_{RM} AT V_{RM} (μA)	CLAMPING VOLTAGE V_C AT I_{PPM} 10/1000 μs		CLAMPING VOLTAGE V_C AT I_{PPM} 8/20 μs		α_T MAX. $10^{-4}/^\circ\text{C}$
	UNI	BI	MIN.	MAX.				(V)	(A)	(V)	(A)	
SM6T6V8A	KE7	KE7	6.45	7.14	10	5.80	1000	10.5	57.0	13.4	298	5.7
SM6T7V5A	KK7	AK7	7.13	7.88	10	6.40	500	11.3	53.0	14.5	276	6.1
SM6T10A	KT7	AT7	9.50	10.5	1.0	8.55	10.0	14.5	41.0	18.6	215	7.3
SM6T12A	KX7	AX7	11.4	12.6	1.0	10.2	5.0	16.7	36.0	21.7	184	7.8
SM6T15A	LG7	LG7	14.3	15.8	1.0	12.8	1.0	21.2	28.0	27.2	147	8.4
SM6T18A	LM7	BM7	17.1	18.9	1.0	15.3	1.0	25.2	24.0	32.5	123	8.8
SM6T22A	LT7	BT7	20.9	23.1	1.0	18.8	1.0	30.6	20.0	39.3	102	9.2
SM6T24A	LV7	LV7	22.8	25.2	1.0	20.5	1.0	33.2	18.0	42.8	93	9.4
SM6T27A	LX7	BX7	25.7	28.4	1.0	23.1	1.0	37.5	16.0	48.3	83	9.6
SM6T30A	ME7	CE7	28.5	31.5	1.0	25.6	1.0	41.5	14.5	53.5	75	9.7
SM6T33A	MG7	MG7	31.4	34.7	1.0	28.2	1.0	45.7	13.1	59	68	9.8
SM6T36A	MK7	CK7	34.2	37.8	1.0	30.8	1.0	49.9	12.0	64.3	62	9.9
SM6T39A	MM7	CM7	37.1	41.0	1.0	33.3	1.0	53.9	11.1	69.7	57	10.0
SM6T68A	NG7	NG7	64.6	71.4	1.0	58.1	1.0	92.0	6.50	121	33	10.4
SM6T100A	NV7	NV7	95.0	105	1.0	85.5	1.0	137	4.40	178	22.5	10.6
SM6T150A	PK7	PK7	143	158	1.0	128	1.0	207	2.90	265	15	10.8
SM6T200A	PR7	PR7	190	210	1.0	171	1.0	274	2.20	353	11.3	10.8
SM6T220A	PR8	PR8	209	231	1.0	188	1.0	328	2.00	388	10.3	10.8

Notes

- (1) For bi-directional devices add suffix "CA"
 (2) V_{BR} measured after I_T applied for 300 μs square wave pulse
 (3) For bi-polar devices with $V_{RM} = 10\text{ V}$ or under, the I_{RM} limit is doubled

THERMAL CHARACTERISTICS ($T_A = 25\text{ }^\circ\text{C}$ unless otherwise noted)			
PARAMETER	SYMBOL	VALUE	UNIT
Typical thermal resistance, junction to ambient air ⁽¹⁾	$R_{\theta JA}$	100	$^\circ\text{C}/\text{W}$
Typical thermal resistance, junction to lead	$R_{\theta JL}$	20	

Note

- (1) Mounted on minimum recommended pad layout

ORDERING INFORMATION (Example)				
PREFERRED P/N	UNIT WEIGHT (g)	PREFERRED PACKAGE CODE	BASE QUANTITY	DELIVERY MODE
SM6T10A-E3/52	0.096	52	750	7" diameter plastic tape and reel
SM6T10A-E3/5B	0.096	5B	3200	13" diameter plastic tape and reel
SM6T10AHE3/52 ⁽¹⁾	0.096	52	750	7" diameter plastic tape and reel
SM6T10AHE3/5B ⁽¹⁾	0.096	5B	3200	13" diameter plastic tape and reel

Note

- (1) AEC-Q101 qualified

RATINGS AND CHARACTERISTICS CURVES ($T_A = 25\text{ }^\circ\text{C}$ unless otherwise noted)

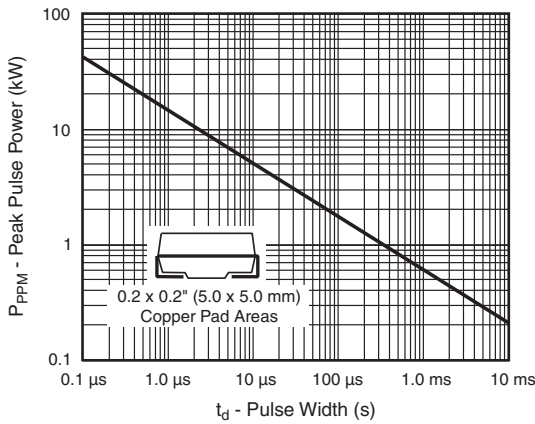

Fig. 1 - Peak Pulse Power Rating Curve

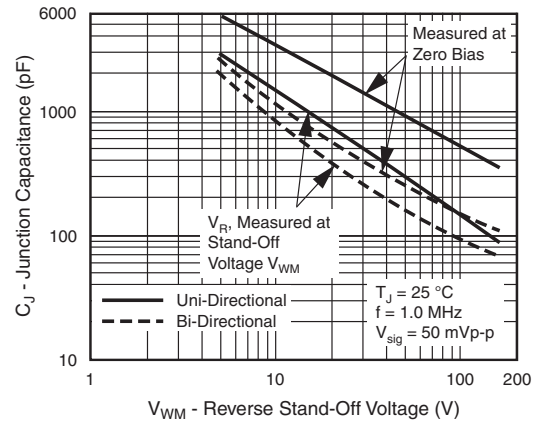

Fig. 4 - Typical Junction Capacitance

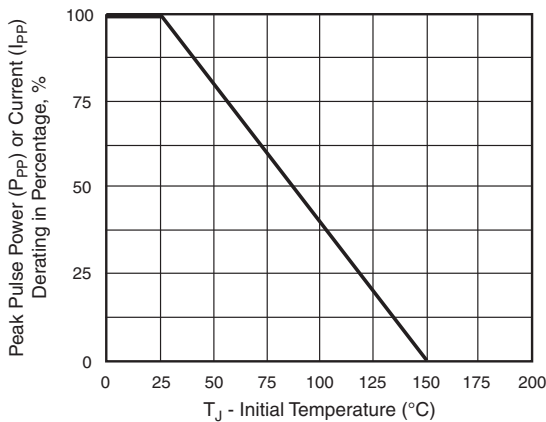

Fig. 2 - Pulse Power or Current vs. Initial Junction Temperature

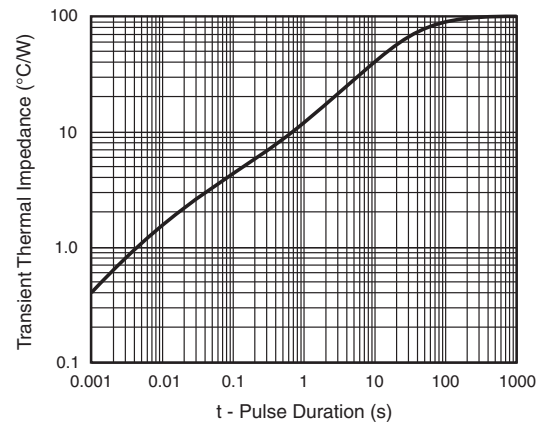

Fig. 5 - Typical Transient Thermal Impedance

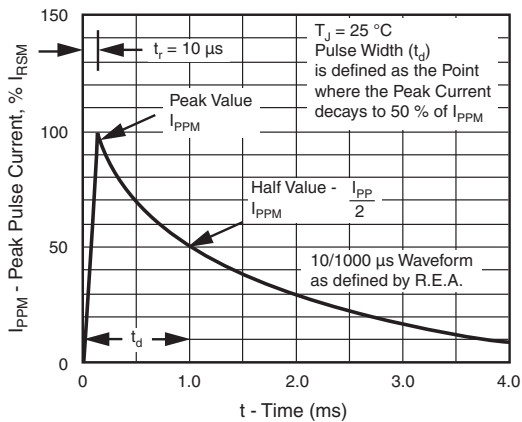

Fig. 3 - Pulse Waveform

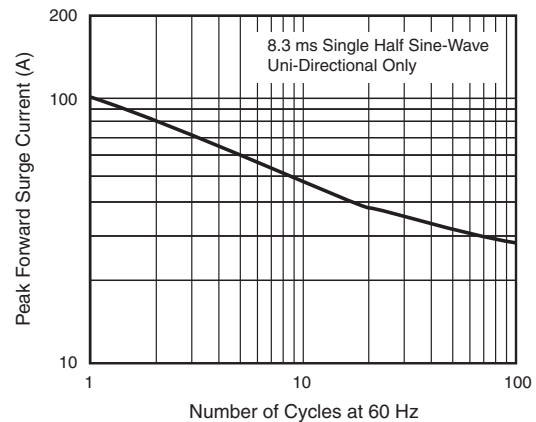
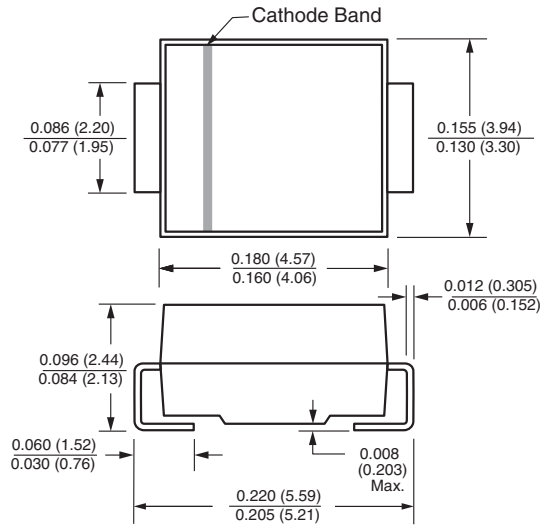

Fig. 6 - Maximum Non-Repetitive Peak Forward Surge Current



PACKAGE OUTLINE DIMENSIONS in inches (millimeters)

DO-214AA (SMB J-Bend)



Mounting Pad Layout

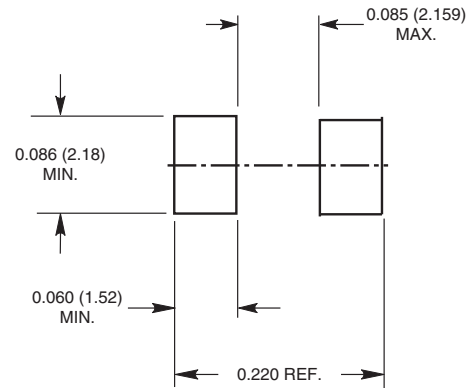



Disclaimer

ALL PRODUCT, PRODUCT SPECIFICATIONS AND DATA ARE SUBJECT TO CHANGE WITHOUT NOTICE TO IMPROVE RELIABILITY, FUNCTION OR DESIGN OR OTHERWISE.

Vishay Intertechnology, Inc., its affiliates, agents, and employees, and all persons acting on its or their behalf (collectively, "Vishay"), disclaim any and all liability for any errors, inaccuracies or incompleteness contained in any datasheet or in any other disclosure relating to any product.

Vishay makes no warranty, representation or guarantee regarding the suitability of the products for any particular purpose or the continuing production of any product. To the maximum extent permitted by applicable law, Vishay disclaims (i) any and all liability arising out of the application or use of any product, (ii) any and all liability, including without limitation special, consequential or incidental damages, and (iii) any and all implied warranties, including warranties of fitness for particular purpose, non-infringement and merchantability.

Statements regarding the suitability of products for certain types of applications are based on Vishay's knowledge of typical requirements that are often placed on Vishay products in generic applications. Such statements are not binding statements about the suitability of products for a particular application. It is the customer's responsibility to validate that a particular product with the properties described in the product specification is suitable for use in a particular application. Parameters provided in datasheets and / or specifications may vary in different applications and performance may vary over time. All operating parameters, including typical parameters, must be validated for each customer application by the customer's technical experts. Product specifications do not expand or otherwise modify Vishay's terms and conditions of purchase, including but not limited to the warranty expressed therein.

Except as expressly indicated in writing, Vishay products are not designed for use in medical, life-saving, or life-sustaining applications or for any other application in which the failure of the Vishay product could result in personal injury or death. Customers using or selling Vishay products not expressly indicated for use in such applications do so at their own risk. Please contact authorized Vishay personnel to obtain written terms and conditions regarding products designed for such applications.

No license, express or implied, by estoppel or otherwise, to any intellectual property rights is granted by this document or by any conduct of Vishay. Product names and markings noted herein may be trademarks of their respective owners.